

Field Termination Plug User Guide

FMPS016A88BK FMPS01C888BK

1.

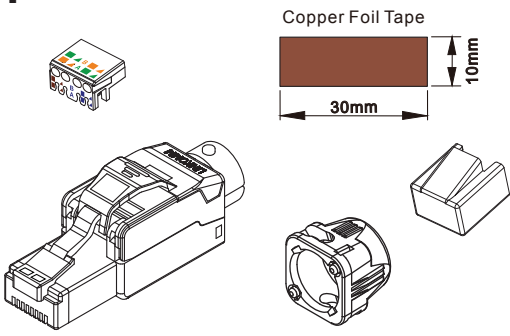

2.

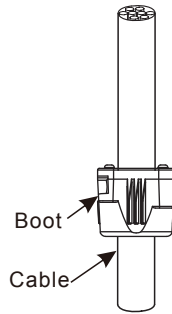

3.

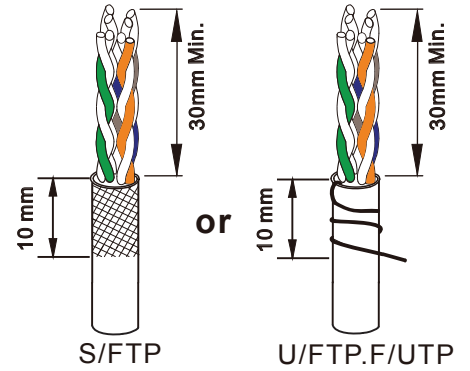

4.

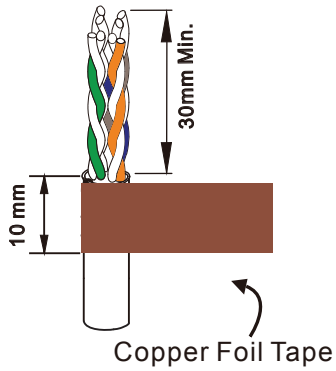

5.

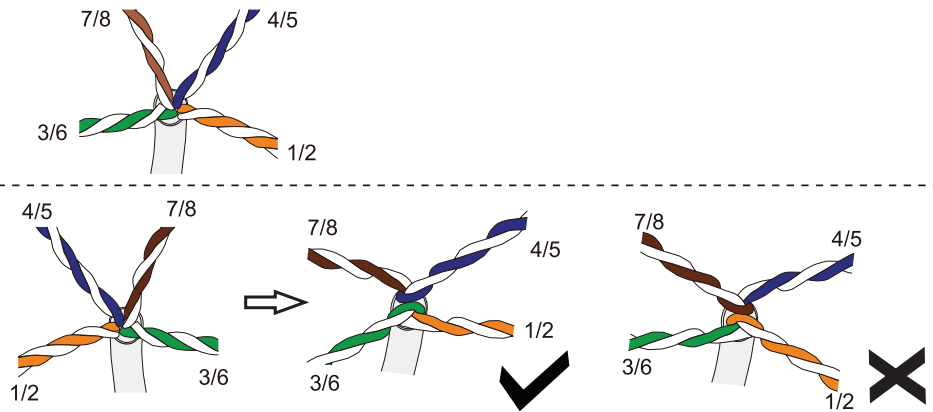

6.

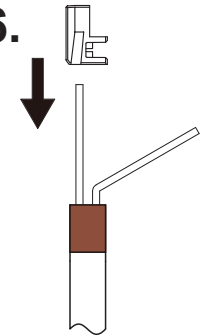

7.

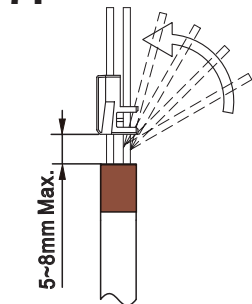

8.

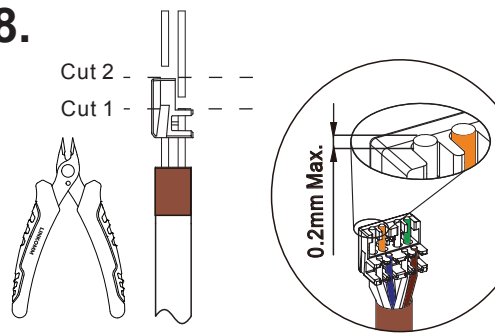

9.

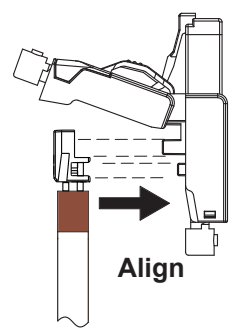

10. Hand Screwing

