

RAMBOO | Butler 3L Automatic Pet Feeder

Manual & Warranty Registration

Please read the manual carefully before using the product
and keep it properly for inquiries

To Valued Customers

Thank you for choosing RAMBOO PET's products. Our company is committed to creating a better life for you and your pet with science and technology.

In order to enable you to use correctly and maintain the product, please read this instruction manual carefully before operation and keep it properly for reference.

Once installed or used, the following safety instructions have been carefully read and accepted. Our company is not responsible for any accidents and losses caused by illegal operations and does not assume any legal liability.

Our company reserves the right of interpretation and modification of this statement.



**Machine Installation And Operation
Instructional Video**



**WARRANTY
REGISTER**

Please use your Phone Camera Scanner
Facebook Search Scanner / WhatsApp Scanner

Daily Feeding Table

(Dog) Weight	Normal	Active	Weight	Normal	Active	Weight	Normal	Active
2kg	39g	45g	8kg	111g	128g	14kg	178g	206-235g
4kg	66g	76g	10kg	131g	152g	16kg	197g	228-259g
6kg	89g	104g	12kg	150g	174g	18kg	215g	249-283g

(Dog) Weight	Normal	Active	Weight	Normal	Active	Weight	Normal	Active
20kg	233g	270-307g	26kg	274g	318-361g	32kg	320g	371-422g
22kg	250g	290-329g	28kg	290g	336-381g	34kg	335g	388-441g
24kg	267g	309-351g	30kg	305g	353-402g	36kg	350g	405-480g

(Cat)Month	1-2	2-4	4-6	6-8	8-12
Suggest	20-30g	30-50g	50-70g	70-80g	80-90g

(Cat)Weight	2-3kg	3-5kg	5-7kg	Pregnancy	Lactation Period
Suggest	25-35g	35-55g	55-85g	70-110g	120-190g

Remark:

*This feeding table is for reference only, the actual feeding amount will be calculated based on the dry food calorie parameters for more accurate calculation, or directly consult the relevant veterinarian.

*If it is found that the pet cannot digest the food in the bowl, the number of meals and the meal time can be appropriately reduced.

Accessory List

*Before installation, please confirm the accessories.

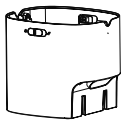

Main Unit *1



Plastic Food Bowl *1

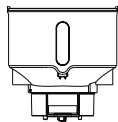

Food Hopper *1

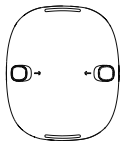

Top Lid *1



Manual *1



Desiccant *1

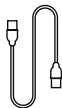

USB-C Cable *1



Adaptor *1



Stainless Steel Bowl *1

Product Introduction

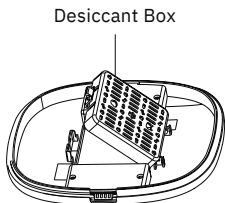
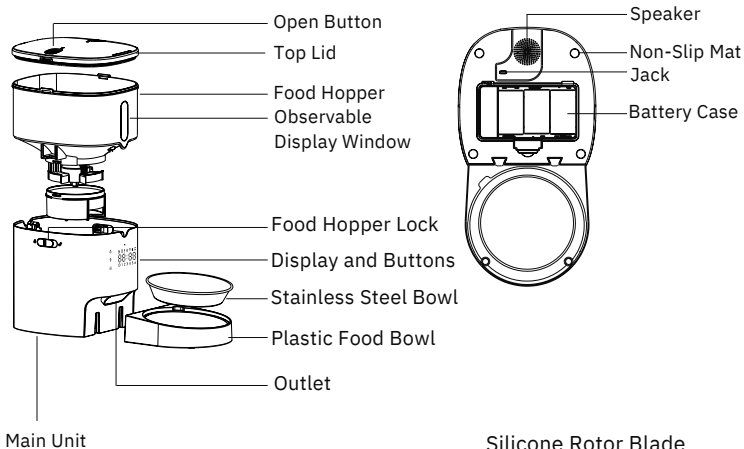

Silicone Rotor Blade

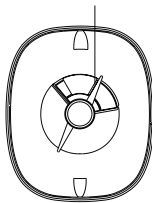

Assemble Guidelines

Power on the device

(Note: The device supports dual power supply)

- 1.It can be powered by a power adapter
- 2.Three D cell batteries, or both.

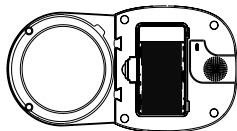
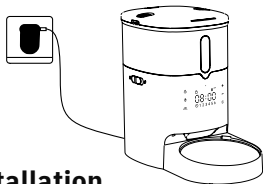

Installation

1. Place the main unit on a horizontal surface and install the plastic food bowl
2. Place the stainless steel bowl in the plastic bowl
3. After confirming that the food hopper is installed in place, lock the food hopper lock

- **Option 1** : Place the food hopper on the main unit according to the correct orientation, press the lock button to unlock the device, then long press the manual feeding button for 3 seconds, the screen will show "----", the main unit will start the food hopper installation **auxiliary function automatically**. In this process of function operation, please keep the food hopper in a right orientation with your hand and wait for the accurate installation of the food hopper.

- **Option 2**: Please ensure the food hopper in the correct installation position, and at the same time, turn the silicone rotor blade(inside the food hopper) to let the food hopper installed in place.

4. Put the desiccant into the desiccant box, and cover the top lid after adding the food to the food hopper to complete the installation.

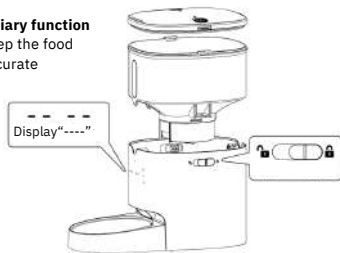

Operating Panel Introduction

Lock Button

Hold for 3 seconds to unlock other buttons and screens



Recording Button

Holding the button for 3 seconds, when you hear the "beep" sound once and the recording icon lights up



This means the recording will start (at most 6 seconds). When you release the button and hear the "beep" sound twice, the recording will be saved



Manual Feeding Button

•(Unlocking state)
Long press the button for 3 seconds to start the "food hopper installation function"

The screen displays "----". After 30 seconds, it will exit the mode automatically

•(Manual feeding state) Press 1 time will distribute 1 portion food, 7-10g per portion

Increase Button

•(Setting state)
Increase the value



•(Manual feeding)
Increase the number of feeding portions

Decrease Button

•(Setting state)
Decrease the value



•(Manual feeding)
Decrease the number of feeding portions



Setting Button

•(Setting state)
Confirm and proceed to the next step; Long press for 3 seconds to exit the setting

•(Time setting state)
Press to enter the setting state

Fault indicator icon

Food stuck: Red light flashing

Food jam: Blue light flashing

Food shortage

Food shortage: White light flashing

Food run out: Red light flashing

Lock iconLights up when other
keys are locked**Time display**Used to display time,
feeding times, feeding
portion and device version**Clock icon**

Blinking: Real-time setting

Light up: Feeding schedule has
been set**Recording icon**Light up when
recording**Battery power icon**

No battery: Blank

Low battery: Red light

Sufficient battery: White light

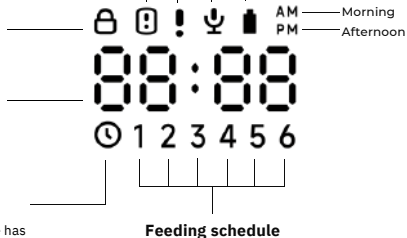

AM — Morning

PM — Afternoon

12-hour clock▶ 24 o'clock in evening
is 12:00 AM▶ 12 o'clock at noon
is 12:00 PM**Feeding schedule**



Setting Introduction

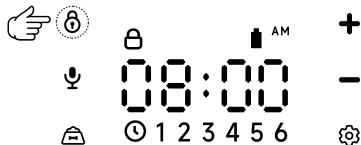

- ▶ Before entering the setting, please long press the lock button  three seconds to unlock other buttons.



- ▶ Press setting button  to enter setting state, and the screen will show as following: (The setting program will jump in turn, please follow the instructions to set in turn)







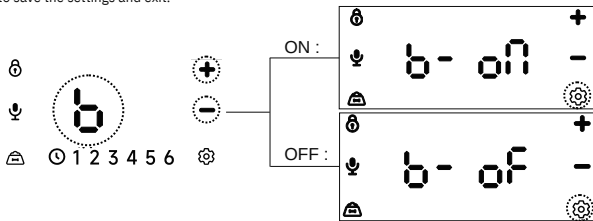

Setting 1: Keytone ON/OFF

Under unlock state, press setting button  to enter setting state. When the "b" shows and flashing, press setting button  to confirm and proceed to the next step.

You can press increase button  or decrease button  to choose ON or OFF, then long press setting button  3 seconds to save the settings and exit.



Setting 2: Real-time Setting

1. Please check the current time of the pet feeder before using it.
2. Unlock the device, then press setting button  to confirm and enter setting state.
3. Press increase button  and decrease button  to select clock icon  to blink, then press setting button  to enter the setting of "hour , minute".
4. When the number is flashing, please press the increase button  or decrease button  to adjust the time you want, then long press the setting button  3 seconds to save settings then exit.

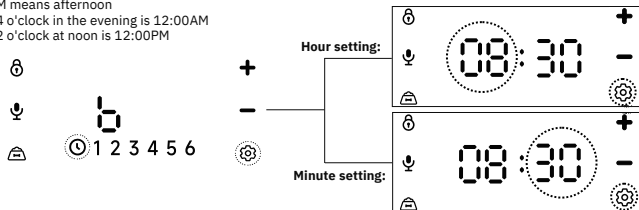

-  Please note, this device is 12 hours system
AM means morning
PM means afternoon
24 o'clock in the evening is 12:00AM
12 o'clock at noon is 12:00PM



Setting 3: Feeding Schedule Setting

1.Meal number setting:

Number "1, 2, 3, 4, 5, 6" means you can set up to 6 meals a day. When number "1" flashing means entering the first meal setting.

If you want to set other meal numbers, please press  or  to adjust the number, then press the setting button  to confirm and enter the "Feeding time setting".

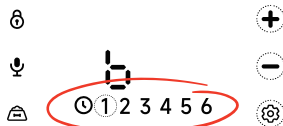

2. Feeding time setting:

The first meal's feeding time setting, you will set the hour and minute in turn. When the time digit flashing, press the **+** button or **-** button to adjust the digit. AM and PM are automatically switched during the setting. Press the setting button  to confirm and proceed to "Feeding portion setting".

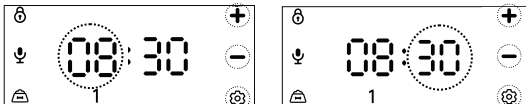

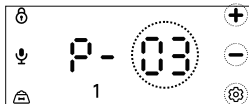

3. Feeding portion setting:

Entering feeding portion setting of per meal, P-01 means 1 portion foods will be provided, each portion will be 7-10g and portion number setting will from 00 to 50. Press **+** or **-** to adjust portions and then press setting button  to confirm and proceed to "Recording playback setting". (The number of grams per portion is for reference only due to the difference size of different pet food.)



4. Recording playback setting:

Entering recording playback setting, A-01 means play the recording once when feeding, and the times of play can be set from 0 to 5. Press **+** or **-** button to select playing times. Then short press setting button  to enter the next meal number setting; long press setting button  3 seconds will save setting and exit.

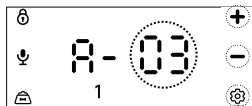

In any state, long press setting button  3 seconds will exit setting, and the screen will display real-time clock and state icon.

Setting 4: Recording Setting

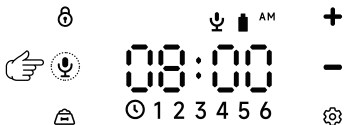





Voice recording/modification:

Under unlock state, long press recording button  3 seconds, when you hear "beep" sound and the recording icon light up at the same time, the recording starts. Release the button to emit the "beep" sound twice means the recording has been saved. The maximum recording duration is 6 seconds.

Play recording:



Short press the recording button  once, and play the recording once.

Setting 5: Manual Feeding Setting

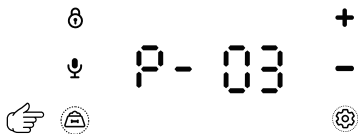

Please press the lock button  to unlock other buttons, short press the manual feeding button  and proceed to manual feeding state. Press increase button  to add a portion, or press the decrease button  to reduce the portion. The maximum manual feeding portion is 5, and the minimum manual feeding portion is 1.



Restore factory setting :

Press  and  at the same time for 5 seconds. The feeding schedule is cleared, real-time is reset to zero, the keytone is enabled by default and the recording will be cleared

Clear the schedule:

Press  and  at the same time for 5 seconds. The schedule will be cleared (schedule time set to zero, feeding portion set to zero, and recording playback times set to zero).

Cleaning Instruction

1. ✓ means washable fitting, ✗ means unwashable.
2. Do not wash the main unit, only can be wiped by cloth.
3. Please clean the stainless steel bowl every day to keep your pet's health.
4. When changing pet foods, the food hopper and plastic food bowl can be removed for cleaning.
 - ① Remove the plastic food bowl from the main unit
 - ② Unlock the hopper lock, and draw up the food hopper
 - ③ Please clean and drain the food hopper and stainless steel bowl (wipe dry) before installing and using.

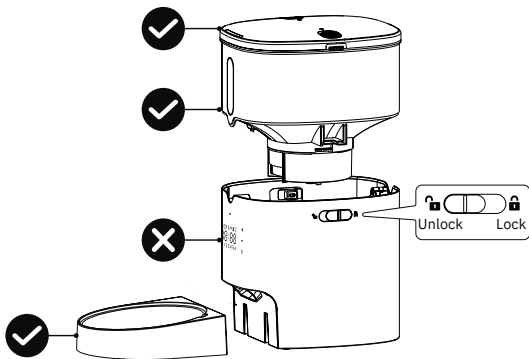

Specification

Capacity	• 3L
Auto Feeding Schedule	• 0-6 meals/day (0-50 portions/meal)
Power	• Backup battery: D cell battery *3 pcs • 5V DC Power cord
Dimension	• 337x179x290mm
Consumption	• < 0.5W

Safety Notice

Failure to comply with the following terms may result in the unavailability of the product or other unexpected losses. To reduce the risk of injury, monitor appliances closely when they are used near children.

- Do not immerse the main unit in water to avoid damage to the control panel and other electronic components.
- Do not use it outdoors or in damp environment such as toilet. Check and maintain regularly to ensure that the grain is delivered correctly.
- Do not use wet or damp food.
- Do not place any foreign objects in the pet feeder.
- This product is only suitable for pet food (diameter between 2-15mm), larger pet food may get stuck.
- Do not place the product on a high place. If the product falls down, it may cause damage or pet safety problems.
- Do not use the feeder for other purposes.
- Please use accessories recommended or sold by the manufacturer and do not modify the pet feeder without authorization.
- In addition to maintenance personnel, other people are not allowed to repair this product, so as to avoid causing various accidental injuries.
- Remove the battery and unplug the power cord when not in use and before cleaning.
- Please use in indoor environment, do not place in the sunlight can be used, it will affect the device work; Keep away from ignition.
- This device is in low voltage mode, but pets biting wires will still cause electricity leakage, please use the correct guidance.
- Keep it horizontal. Do not knock over the device. Otherwise, the device may not work properly.
- If the owner needs to go out, please check the battery in the battery box to ensure sufficient battery power (this product is only suitable for alkaline batteries).

RAMBOO PET Warranty Policy

1. The warranty period of this product is 5 years; Full Warranty service is provided for the first 12 months, and Warranty service is provided proportionally after 12 months.
2. Those who fail to complete the Warranty registration within one month after purchasing the product will be deemed to have given up the 5-year Pro-Rata Warranty service rights and only provide 1-year Full Warranty service.
3. During the warranty period, the failure caused by normal use in accordance with the instruction manual (determined by the company's official staff) will be guaranteed.
4. During the warranty period, if one of the following situations occurs, it must be repaired as a fee:
 - The warranty card and valid shopping voucher cannot be provided.
 - Failure and damage caused by misuse and non-professional repair.
 - Failures and damages caused by transportation, moving and dropping after purchase.
 - Failure and damage caused by other unavoidable external factors.
 - Failure and damage caused by water or other solutions in the equipment caused by improper use.
 - Failure and damage caused by the use of non-equipment working power.
5. Product accessories and consumables are not covered by the warranty.
6. Free original replacement application process:
 - The product does not need to bear any cost during the first 12 months of warranty, and after 12 months of warranty service, the return shipping fee will be charged.
 - Provide warranty information, original proof of purchase or receipt that can check the purchase record.
 - Through the online customer service system Email, Messenger, Whatsapp, Shopee chat, provide the defective products you purchased complete and clear video photos, as well as purchase channels, names, phone numbers and other information.
 - Special personnel will handle the cases in sequence according to the time of receipt, please wait patiently.
7. Only the above guarantees are made, and no other express or implied guarantees (including implied warranties of merchantability, reasonableness and adaptability for a specific application, etc.) are made, whether in contracts or civil faults or otherwise, the company is not responsible for any special, incidental or indirect damages.
8. This warranty is only valid within Malaysia.

5 Years Pro-Rata Warranty Policy

Months	0-12	12-18	18-24	24-30	30-36	36-42	42-48	48-54	54-60
Trade In Discount%	F.O.C	45%	35%	25%	20%	10%	10%	10%	10%
Claim	Claim & Continue Date of Warranty					Claim & Renew Warranty			
Claim Price	Depends on the price at the time of purchase(Receipt), and the maximum claim of the price is RM348								

TERMS & CONDITIONS APPLY

**The Detailed Policy Will Be Based On The Latest
Announcement On The Official Website.**



Scan & Get More Detail
TERMS & CONDITIONS APPLY

RAMBOO PET Customer Service

Have any problem? Don't worry, Please contact us.



FB Messenger



Whatsapp

Please use your Phone Camera Scanner
Facebook Search Scanner / WhatsApp Scanner

Email Contact
service@ramboopet.com



RAMBOO
VIP FANS CLUB

Join & Share Your Pet Life

We Will Provide VIP Exclusive Benefits & Promotion From Time To Time

www.ramboopet.com