

SAFE SERIES



SAFE SERIES

EVO-SAFE SERIES BURGLAR & FIRE RESISTANT SAFE



Digital Lock



Digital Lock



Digital Lock



Keyless Combination Lock
(available in 3 or 4 wheel)



Time Lock (available in 2 or 3 movements)



Back Trap



Front Trap



Internal Drawers -
Refer Representative For
Drawer Configuration



Gun Racks with Ammunition
Storage Compartment

The elegance of simplicity and the essence of comfort.

SAFE SERIES

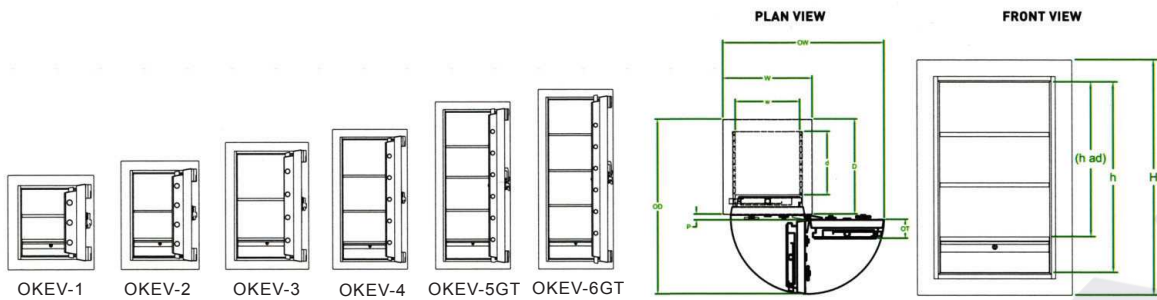

MODEL	EXTERNAL (mm)				DOOR @ 90°	DOOR @ 180°	INTERNAL (mm)			
	(H)	(W)	(D)	(D+P)	(OD)	(OW)	(h)	(had)	(w)	(d)
OKEV-1	710 [28"]	648 [25.5"]	680 [26.8"]	730 [28.7"]	1255 [51.2"]	1170 [46.1"]	500 [19.7"]	375 [14.8"]	438 [17.2"]	410 [16.2"]
OKEV-2	900 [35.5"]	648 [25.5"]	724 [28.5"]	774 [30.5"]	1305 [51.4"]	1165 [45.9"]	698 [27.4"]	547 [21.5"]	438 [17.2"]	454 [17.9"]
OKEV-3	1105 [43.5"]	724 [28.5"]	775 [30.5"]	825 [32.5"]	1430 [56.3"]	1320 [52"]	895 [35.2"]	726 [28.6"]	514 [20.2"]	505 [19.9"]
OKEV-4	1422 [56"]	762 [30"]	813 [32"]	863 [34"]	1500 [59"]	1395 [55"]	1212 [47.7"]	1037 [40.8"]	552 [21.7"]	543 [21.4"]
OKEV-5GT	1702 [67"]	762 [30"]	813 [32"]	863 [34"]	1500 [59"]	1395 [55"]	1490 [58.7"]	1290 [50.8"]	550 [21.6"]	535 [21.1"]
OKEV-6GT	1829 [72"]	762 [30"]	813 [32"]	863 [34"]	1500 [59"]	1395 [55"]	1617 [63.7"]	1417 [55.8"]	550 [21.6"]	535 [21.1"]

EXTERNAL: (H) — HEIGHT / (W) — WIDTH / (D) — DEPTH / (D+P) — OVERALL DEPTH + HANDLE

INTERNAL: (h) — height / (w) — width / (d) — depth / (had) — height above drawer

SIZE	STANDARD FITTINGS	APPROXIMATE NETT WEIGHT	PACKING CASE SIZE	GROSS WEIGHT
OKEV-1	1 full width drawer 3 moving bolts 1 top moving bolt 1 adjustable shelf 1 vertical rebate 1 bottom moving bolt	620kgs	910mm x 810mm x 900mm	660kgs
OKEV-2	1 full width drawer 4 moving bolts 1 top moving bolt 1 adjustable shelf 1 vertical rebate 1 bottom moving bolt	823kgs	1100mm x 810mm x 900mm	863kgs
OKEV-3	1 full width drawer 4 moving front bolts 1 top moving bolt 1 adjustable shelf 1 vertical rebate 1 bottom moving bolt	1104kgs	1310mm x 900mm x 1000mm	1154kgs
OKEV-4	1 full width drawer 5 moving front bolts 1 top moving bolt 2 adjustable shelves 1 vertical rebate 1 bottom moving bolt	1468kgs	1620mm x 930mm x 1000mm	1538kgs
OKEV-5GT	1 full width drawer 6 moving front bolts 2 top moving bolt 3 adjustable shelves 1 vertical rebate 2 bottom moving bolts	1780kgs	1900mm x 930mm x 1050mm	1860kgs
OKEV-6GT	1 full width drawer 6 moving front bolts 2 top moving bolt 3 adjustable shelves 1 vertical rebate 2 bottom moving bolts	1900kgs	2050mm x 950mm x 1050mm	1980kgs

NOTE: Maximum permissible deviation is ±10% for weight
In the interest of our clients, certain details concerning the protective features of MOEM Evo Series safes have not been disclosed in this brochure. Such information can however be obtained by consulting your MOEM representatives.

NOTE: As our policy is one of consistent improvement, we reserve the right to alter any part of this specifications without notice and without incurring any obligation.

The elegance of simplicity and the essence of comfort.

SAFE SERIES

AvanGuard SERIES BURGLAR & FIRE RESISTANT SAFE



HIGH SECURITY SAFE



Certificate No. 466300 / 466301



The elegance of simplicity and the essence of comfort.

AVANGUARD SERIES SPECIFICATIONS

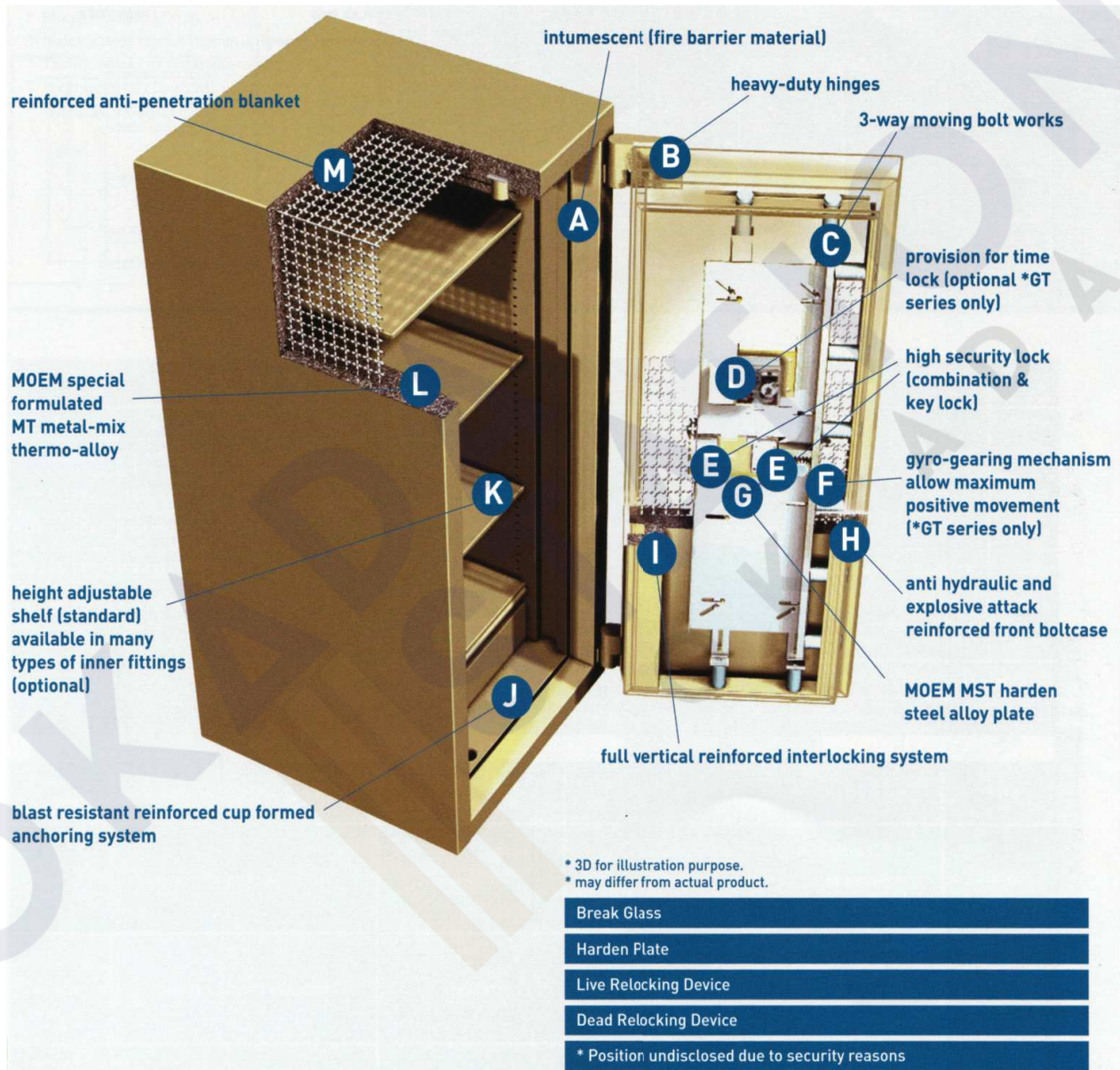

The elegance of simplicity and the essence of comfort.

SAFE SERIES

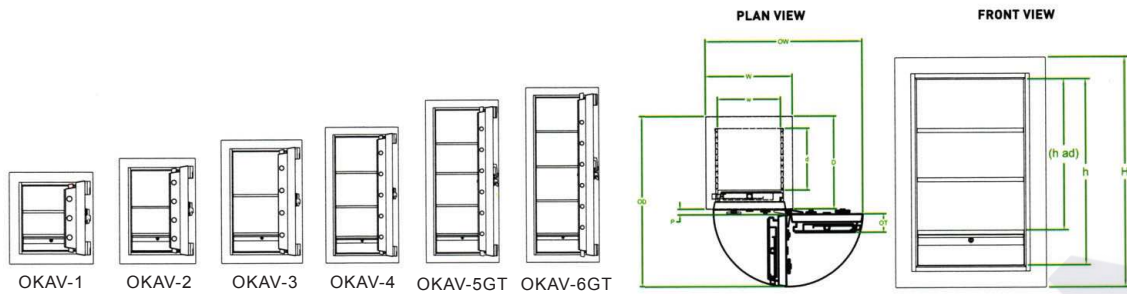

	EXTERNAL (mm)				DOOR @ 90°	DOOR @ 180°	INTERNAL (mm)			
MODEL	(H)	(W)	(D)	(D+P)	(OD)	(OW)	(h)	(had)	(w)	(d)
OKAV-1	710 (28")	648 (25.5")	680 (26.8")	730 (28.7")	1255 (51.2")	1170 (46.1")	500 (19.7")	375 (14.8")	438 (17.2")	410 (16.2")
OKAV-2	900 (35.5")	648 (25.5")	724 (28.5")	774 (30.5")	1305 (51.4")	1165 (45.9")	698 (27.4")	547 (21.5")	438 (17.2")	454 (17.9")
OKAV-3	1105 (43.5")	724 (28.5")	775 (30.5")	825 (32.5")	1430 (56.3")	1320 (52")	895 (35.2")	726 (28.6")	514 (20.2")	505 (19.9")
OKAV-4	1422 (56")	762 (30")	813 (32")	863 (34")	1500 (59")	1395 (55")	1212 (47.7")	1037 (40.8")	552 (21.7")	543 (21.4")
OKAV-5GT	1702 (67")	762 (30")	813 (32")	863 (34")	1500 (59")	1395 (55")	1490 (58.7")	1290 (50.8")	550 (21.6")	535 (21.1")
OKAV-6GT	1829 (72")	762 (30")	813 (32")	863 (34")	1500 (59")	1395 (55")	1617 (63.7")	1417 (55.8")	550 (21.6")	535 (21.1")

EXTERNAL: (H) — HEIGHT / (W) — WIDTH / (D) — DEPTH / (D+P) — OVERALL DEPTH + HANDLE
 INTERNAL: (h) — height / (w) — width / (d) — depth / (had) — height above drawer

SIZE	STANDARD FITTINGS	APPROXIMATE NETT WEIGHT	PACKING CASE SIZE	GROSS WEIGHT
OKAV-1	1 full width drawer 3 moving bolts 1 top moving bolt 1 adjustable shelf 1 vertical rebate 1 bottom moving bolt	563kgs	910mm x 810mm x 900mm	603kgs
OKAV-2	1 full width drawer 4 moving bolts 1 top moving bolt 1 adjustable shelf 1 vertical rebate 1 bottom moving bolt	743kgs	1100mm x 810mm x 900mm	783kgs
OKAV-3	1 full width drawer 4 moving front bolts 1 top moving bolt 1 adjustable shelf 1 vertical rebate 1 bottom moving bolt	1013kgs	1310mm x 900mm x 1000mm	1063kgs
OKAV-4	1 full width drawer 5 moving front bolts 1 top moving bolt 2 adjustable shelves 1 vertical rebate 1 bottom moving bolt	1338kgs	1620mm x 930mm x 1000mm	1408kgs
OKAV-5GT	1 full width drawer 6 moving front bolts 2 top moving bolt 3 adjustable shelves 1 vertical rebate 2 bottom moving bolts	1611kgs	1900mm x 930mm x 1050mm	1691kgs
OKAV-6GT	1 full width drawer 6 moving front bolts 2 top moving bolt 3 adjustable shelves 1 vertical rebate 2 bottom moving bolts	1714kgs	2050mm x 950mm x 1050mm	1794kgs

NOTE: Maximum permissible deviation is ±10% for weight
 In the interest of our clients, certain details concerning the protective features of MOEM AvantGuard Series safes have not been disclosed in this brochure.
 Such information can however be obtained by consulting your MOEM representatives.

NOTE: As our policy is one of consistent improvement, we reserve the right to alter any part of this specifications without notice and without incurring any obligation.

The elegance of simplicity and the essence of comfort.

SAFE SERIES

24 HOURS DEPOSITORY SYSTEM

DEPOSITORY SYSTEM (DRAWER TRAP SYSTEM)

Drawer trap system allows deposit of cash and documents without having to open the main safe door. System is fitted with an anti-fishing plate to deter fishing of content from the safe. Drawer trap is also lockable. Model AV-1, AV-2 and AV-3 can be fitted with depository system (drawer trap).

FRONT DRAWER TRAP



CROSS-SECTION - FRONT DRAWER TRAP

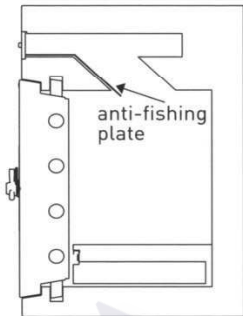

BACK DRAWER TRAP

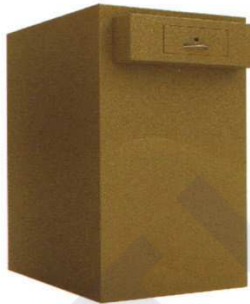

CROSS-SECTION - BACK DRAWER TRAP

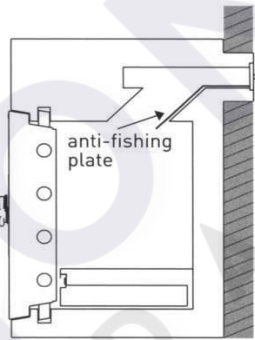

- 915mmH x 648mmW x 730mmD
- 1105mmH x 648mmW x 774mmD
- 1307mmH x 724mmW x 825mmD

- * Exclusion from SP certification.
- * Back Drawer Trap (Refer Representative for Detailed Drawings).

INTERNAL FITTINGS

- * Safe Fitted with Internal Drawers
Various Sizes, Compartments
and Combinations Available
(Refer Representatives)
- * Safe for Armoury
(Refer Representative)

SAFE FITTED WITH INTERNAL DRAWERS



SAFE FOR ARMOURY

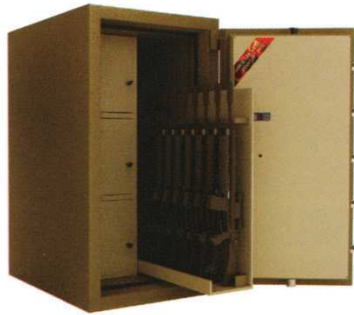

The elegance of simplicity and the essence of comfort.

SAFE SERIES



COMPACT SERIES SAFE

BURGLAR & FIRE RESISTANCE



MOEM Compact series safe is designed for medium range protection for your valuables and important documents against burglary and fire. Compact series safe is designed for easy operations and everyday use in small businesses, homes and other commercial applications.

FEATURES

DOOR & BODY

The overall thickness of door measures 100mm with an effective specially formulated thermo-alloy MT metal-mix barrier material protective thickness of 50mm. The design form an integral part of the door structure strength together with locking mechanism. The overall thickness of body measures 65mm encased with MOEM specially formulated thermo-alloy MT metal-mix barrier material composite.

BOLT-WORK & LOCKING MECHANISM

Compact series safe is designed with a 3 way running bolt-work locking system. The door is further secured by full vertical interlocking system. Bolt measures 25mm in diameter.

Compact series safe comes complete with 3 wheel keyless combination lock (1,000,000 combination variation) and a key lock. Other locking options such as digital lock available as accessories. (optional).

INTERNAL FITTINGS

Compact series safe comes complete with one adjustable steel

shelf. Model MS200, MS300 and MS300T comes complete with a lockable internal bottom drawer.

FIRE RESISTANCE

Safe is tested for 30 minutes in accordance to JIS 1037:1989 (Japanese Industrial Standard).
[*refer test report]

- Door Protective Thickness 50mm
- Body Protective Thickness 65mm
- Thermo-Alloy MT Metal-Mix Barrier Material
- 3-Way Running Bolt
- Internal Fittings
- Fire Resistance

The elegance of simplicity and the essence of comfort.

SAFE SERIES

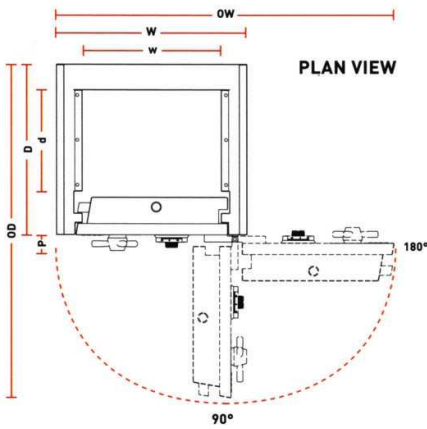

MODEL	EXTERNAL (mm and inches)				DOOR @ 90°	DOOR @ 180°	INTERNAL (mm)				WEIGHT (KGS)
	(H)	(W)	(D)	(D+P)	(OD)	(OW)	(h)	(had)	(w)	(d)	
OKMS100	385 (15.2")	533 (21")	457 (18")	502	920	970	245	—	393	270	170
OKMS200	584 (23")	508 (20")	533 (21")	578	985	925	445	318	368	360	250
OKMS300	685 (27")	508 (20")	533 (21")	578	985	925	545	420	368	360	285
OKMS100T	508 (20")	533 (21")	457 (18")	502	920	970	245	200	393	270	210
OKMS300T	813 (32.1")	508 (20")	533 (21")	578	985	925	545	395	368	360	330

EXTERNAL: (H) — HEIGHT / (W) — WIDTH / (D) — DEPTH / (D+P) — OVERALL DEPTH
INTERNAL: (h) — height / (w) — width / (d) — depth / (had) — height above drawer



MS100T & MS300T (DRAWER TRAP SYSTEM)

Drawer trap system allows deposit of cash and documents without having to open the main safe door. System is fitted with an anti-fishing plate to deter fishing of content from the safe. Drawer trap is also lockable. These features are ideally suited for retailers i.e kiosks, gasoline stations, restaurants, mini-marts and others where there is turnover of employee shifts and cash turnover.

ACCESSORIES

Digital lock / Envelope slot / *Other special fittings
Standard colour: Light Grey

- * Safe comes complete with 1 adjustable shelf
- * MS200, MS300 & MS300T come complete with internal drawer
- * Ensure door able to open 180° to maximize usage & drawer usage
- * Recommended to allow 25mm gap on each side
- * Internal height MS100T & MS300T is measured up to anti-fishing plate
- * D+P-Overall depth + handle
- * OD-Overall depth door @90°
- * OW-Overall width door @180°
- * Had-Height above drawer *except MS100T
- * Floor bolting to be specified before manufacturing
- * Measurement in inches (") as guide
- * Weight ±10%

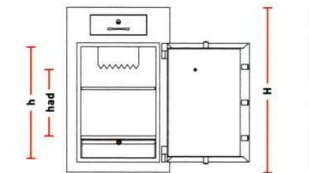
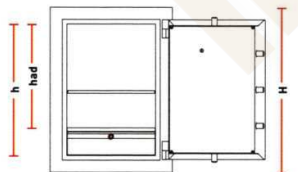
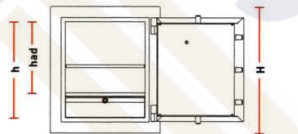
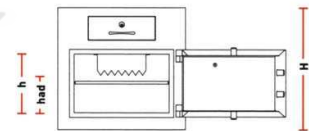
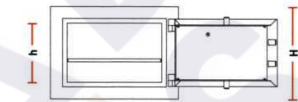

The elegance of simplicity and the essence of comfort.

SAFE SERIES

FIRE RESISTANT CABINET



MOEM series of fire resistant cabinet offers protection for valuables against fire. MOEM series of fire resistant cabinet are the result of extensive research & development, designed to fulfill international standards. MOEM series of fire resistant cabinet is tested and certified by SP Technical Research Institute of Sweden based on fire resistance classification NT Fire 017 that is recognized internationally.



Features:-

Protective thickness of door & body

Overall thickness of door and body measures 50mm thickness comprising of MOEM special fire resistant barrier material encased between electro-galvanized steel (EG) door and body.

Individual compartment

Inner compartment is designed individually. The independent concept allows individual protection against fire should any drawers be left open in case of fire.

Heavy duty metal railing

The drawers are suspended on heavy duty metal railings with metal bearing rollers for added strength and durability. The drawers are capable of taking weight up to 80kgs UDL. The heavy duty railings are rainbow coated for resistance against rust.

Double tongue & groove construction

The advanced S-design construction between body and drawer front prevents the passage of flame. Intumescent strips are used for added protection against the passage of flame.

Locking system

The fire resistant cabinet is secured by key lock and keyless combination lock (central locking). The drawers are also fitted with flip lever that allows overriding of central locking for individual control options. Individual key lock and digital lock are available as option.

Plinth & Handle

A special shock absorbing plinth is designed to break the fall. External user-friendly press button handle is designed to allow maximum insulation without compromising protective thickness of door. Aesthetic look, ease of operation, user friendliness and injury free usage has been taken into consideration.

Finishes

Epoxy Powder Coated



Certificate No: 466302



Key Lock & Combination



Dual Key Lock



Twin Deck Drawer



Key Lock



Digital Lock

The elegance of simplicity and the essence of comfort.

SAFE SERIES

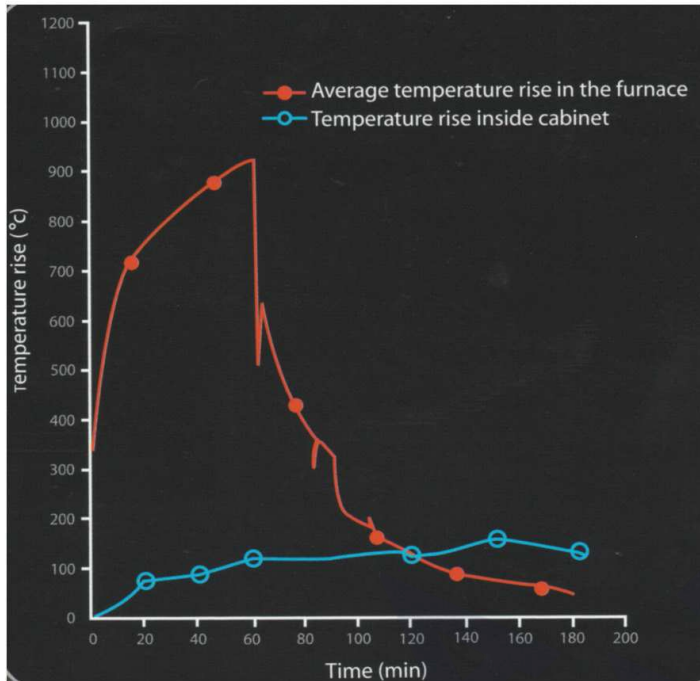

Model	External Dimension	Weight
OKFRC 2 (2 drawers)	826mmH x 530mmW x 770mmD	192Kgs
OKFRC 3 (3 drawers)	1188mmH x 530mmW x 770mmD	260Kgs
OKFRC 4 (4 drawers)	1550mmH x 530mmW x 770mmD	360Kgs
Internal Dimension		
Drawer	292mmH x 386mmW x 635mmD	

*Note: Permissible Deviation is ±10% for weight

*Standard color light gray (Epoxy Powder Coated)



The elegance of simplicity and the essence of comfort.