

Product Range International

PE Systems

Utility and Industry

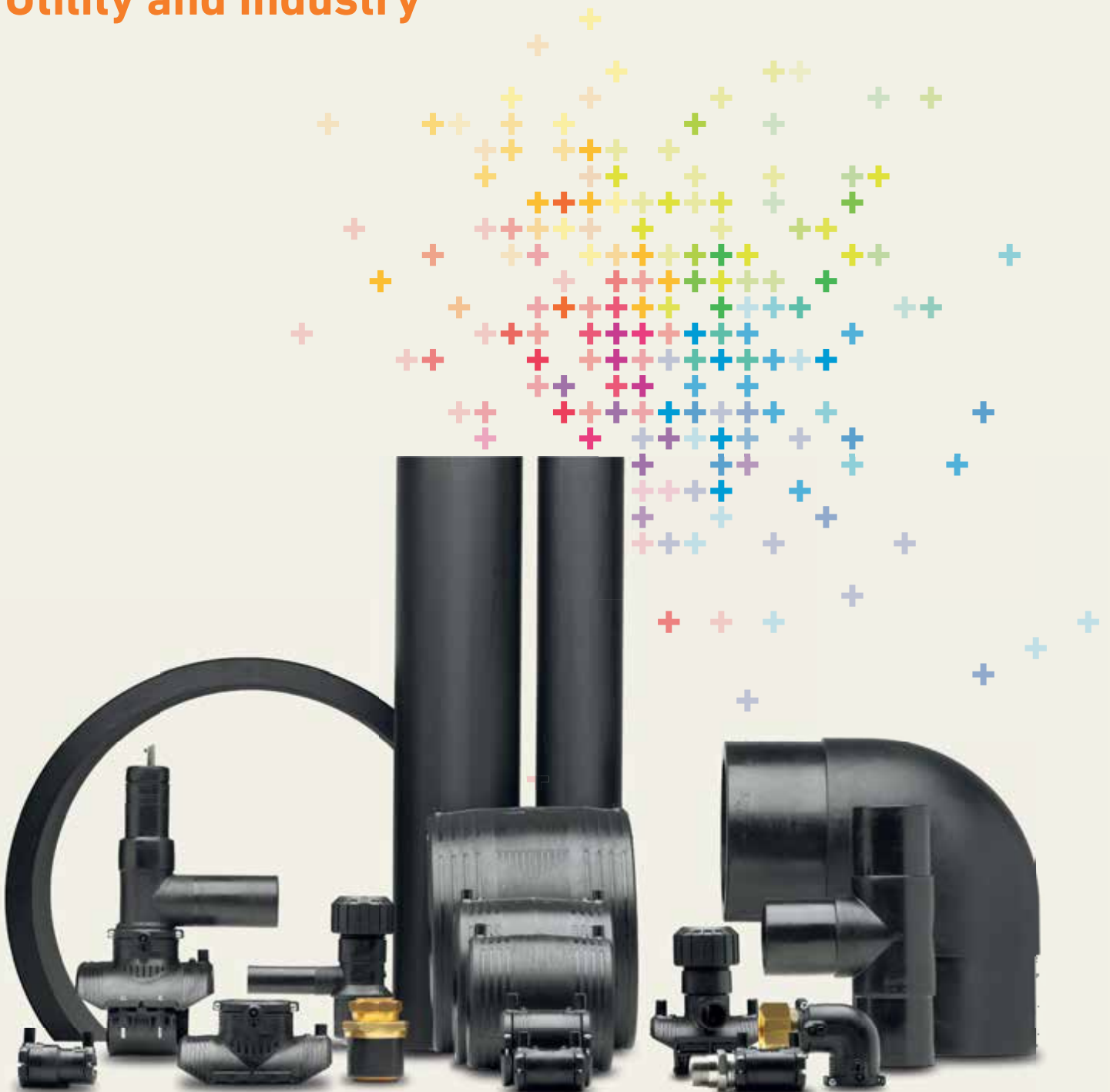

Table of contents

PE for Utility Systems	4
PE for Industrial Systems	102
Flange connections	171
FM Pipe	200
Accessories	204
Index	206
General Conditions	222

PE for Utility Systems

Utility Range

General information	6
ELGEF Plus electrofusion fittings	14
ELGEF Plus saddles and valves	33
ELGEF Plus branch saddle	56
Spigot fittings in PE100	61
ELGEF Plus valves	85

General Information

Packaging	GP pcs. pal. kg pal. vol. pal.	Pieces per Bulk Pack pieces per pallet weight per pallet volume per pallet (including pallet)
Measures, units and short cuts	d, d1, d2 DN L, L1, L2 H, H1, H2 e, e1, e2 kg SC AL S SDR	diameter nominal diameter length height wall thickness weight size of bolts number of bolt holes pipe series Standard Dimension Ratio
Working pressure	The pressure rating of Georg Fischer PE-Fittings refers to the calculated values of EN 12201 and EN 1555 considering the total security value. National Regulations and standards have to be observed.	
Specification	Georg Fischer Fittings meet the ISO-standards, CEN-standards (respectively draft standards) as well as other national standards.	
Approval	The Georg Fischer products are subjected to extensive internal and external tests and are approved by all major institutes and approval authorities (for example: DVGW, SVGW, KIWA, IIP, Gaz de France, Gas Natural, etc.).	
General Conditions of Supply	Please find the General Conditions of Supply on the last page.	
Works certificates	Works certificates corresponding EN 10204 2.2 will be delivered on request. Works certificates corresponding EN 10204 3.1 will be delivered on request, we will charge CHF 20.– administrative costs.	
Quality management Environmental management	Quality management system is well established at Georg Fischer and is continuously improved to satisfy our customers. Georg Fischer Piping Systems are certified according to ISO 9001 as well as ISO 14001 (Environmental management).	
Technical documentation	For further technical information we offer you the Georg Fischer “Technical handbook distribution” and the detailed assembly instructions.	
Service, training and consultation	Our comprehensive training program offers you the possibility for extensive advice and training. Please reserve for a our training program for piping systems.	
Your partner	Georg Fischer is a world-wide organisation. Please find the address of your Georg Fischer partner on the back cover.	



Certificate

SQS herewith certifies that the company named below has a management system which meets the requirements of the standards specified below.



GEORG FISCHER
PIPING SYSTEMS

Georg Fischer Piping Systems Ltd.
8201 Schaffhausen, Switzerland

Certified area

Georg Fischer Piping Systems Ltd., Schaffhausen
(ISO 9001:2008, ISO 14001:2004, OHSAS 18001:2007)
Georg Fischer Piping Systems (Switzerland) Ltd., Sales Company
(ISO 9001:2008)
Georg Fischer Wavin Ltd., Schaffhausen and Subingen
(ISO 9001:2008, ISO 14001:2004, OHSAS 18001:2007)
Georg Fischer JRG Ltd., Sissach
(ISO 9001:2008, ISO 14001:2004, OHSAS 18001:2007)
Georg Fischer Fluoropolymer Products GmbH, Ettenheim
(ISO 9001:2008, ISO 14001:2004, OHSAS 18001:2007)

Field of activity

GF Piping Systems is a leading supplier of plastic and metal pipe systems with a global market presence.
GF Piping Systems offers connection technology, fittings, fixtures, sensors and pipes and supplies leading innovative technical solutions for domestic engineering applications, industry and utilities.

Standards

ISO 9001:2008 **Quality Management System**
ISO 14001:2004 **Environmental Management System**
OHSAS 18001:2007 **Occupational Health and Safety Management System**

Swiss Association for Quality and Management Systems SQS
Bernstrasse 103, CH-3052 Zollikofen
Issue date: Mai 28, 2012

This SQS Certificate is valid up to and including Mai 27, 2015
Scope number 14
Registration number 10684

X. Edelmann, President SQS

R. Glauser, Managing Director SQS



SCESm 001



Swiss Made



ELGEF Plus APPROVALS



Certification body	Certificate number	Material	Product range	Country
DGS	04 MAT.PA 002	PE 100	Electrofusion couplers	France
DGS	04 MAT.PA 010	PE 100	Fittings, Spigot	France
DIBt	Z-40.23-282	PE 100, PE 80	Electrofusion couplers, Fittings, Butt Fusion - Transition, Fittings, Butt fusion, mm, Fittings, Socket fusion - Transition, Fittings, Socket fusion, mm, Union, Butt Fusion, Union, Socket Fusion	Germany
DIBt	Z-40.23-282	PE 100, PE 80	Electrofusion couplers, Fittings, Butt Fusion - Transition, Fittings, Butt fusion, mm, Fittings, Socket fusion - Transition, Fittings, Socket fusion, mm, Union, Butt Fusion, Union, Socket Fusion	Germany
DS	1594-A	PE 100	Electrofusion couplers, Electrofusion fittings, Electrofusion fittings, Electrofusion saddles	Denmark
DVGW	DV-6611AS2072 (GF)	PE 100	Electrofusion tapping valves	Germany
DVGW	DV-8601AQ3257 (8601)	PE 100, PE 100/Brass, PE 100/Steel, PE 80	Electrofusion couplers, Electrofusion fittings, Electrofusion saddles, Fittings, Spigot, Fittings, Transition	Germany
DVGW	DV-8606AQ3258 (8606)	PE 100, PE 100/Brass, PE 100/Steel, PE 80	Electrofusion branch fitting, Electrofusion couplers, Electrofusion fittings, Electrofusion saddles, Fittings, Spigot, Fittings, Transition	Germany
DVGW	DV-8611AQ3259 (8611)	PE 100, PE 80	Electrofusion branch fitting, Electrofusion couplers, Electrofusion fittings, Electrofusion saddles, Fittings, Spigot	Germany
ETI	2-8-7/58	PE 100, PE 100/Brass, PE 80	Electrofusion couplers, Electrofusion fittings, Electrofusion saddles, Fittings, Spigot, Fittings, Transition, Valves	Estonia
GdF	2002-082/AD	PE 100	Electrofusion fittings	France
GdF	2002-083/AD	PE 100	Fittings, Spigot	France
GdF	2003-033/PH	PE 100	Electrofusion couplers	France
GdF	2003-034/PH	PE 100	Electrofusion saddles	France
GdF	2004-081/AD	PE 100	Electrofusion saddles	France
GdF	95/020-AD	PE 100	Electrofusion couplers	France
GdF	95/052-AD	PE 100	Electrofusion couplers	France
GdF	BTR	PE 100	Valves, plug	France
GdF	PRISES SDG	PE 100	Electrofusion saddles	France

Certification body	Certificate number	Material	Product range	Country
ITC	02 0426 V/AO	PE 100	Electrofusion couplers, Electrofusion fittings, Electrofusion saddles, Fittings, Spigot	Czech Republic
MHEW	Water 2004	Machine, PE 100, PE 80	Electrofusion branch fitting, Electrofusion control units, Electrofusion couplers, Electrofusion fittings, Electrofusion saddles, Fittings, Butt fusion, mm	Oman
NIGC	Certificate acc IGS-MS-PL-014 part 2	PE 100	Electrofusion couplers, Electrofusion fittings, Electrofusion saddles, Fittings, Spigot	Iran
ON	ON-N 2005 120 ... 130	PE 100, PE 100/Steel	Electrofusion branch fitting, Electrofusion couplers, Electrofusion fittings, Electrofusion saddles, Electrofusion tapping valves, Fittings, Spigot, Fittings, Transition	Austria
ÖVGW	G 1.321	PE 100, PE 80	Electrofusion branch fitting, Electrofusion couplers, Electrofusion fittings, Electrofusion saddles, Electrofusion tapping valves, Fittings, Socket fusion, mm, Fittings, Spigot	Austria
ÖVGW	G 2.450	PE 100/Steel	Fittings, Transition	Austria
ÖVGW	W 1.229	PE 100, PE 100/Brass, PE 100/Steel, PE 80	Electrofusion branch fitting, Electrofusion couplers, Electrofusion fittings, Electrofusion saddles, Electrofusion tapping valves, Fittings, Socket fusion, mm, Fittings, Spigot, Fittings, Transition	Austria
PROMNAZOR	7/727-1140	PE 100, PE 80	Electrofusion couplers, Electrofusion saddles, Fittings, Spigot	Kasastan
SVGW	G 02-014-9	PE 100, PE 100/Steel, PE 80	Electrofusion branch fitting, Electrofusion couplers, Electrofusion fittings, Electrofusion saddles, Electrofusion tapping valves, Fittings, Spigot, Fittings, Transition	Switzerland
SVGW	W 9506-K 192	PE 100, PE 100/Brass, PE 100/Steel, PE 80	Electrofusion branch fitting, Electrofusion couplers, Electrofusion fittings, Electrofusion saddles, Electrofusion tapping valves, Fittings, Spigot, Fittings, Transition	Switzerland
WBS	9901515	PE 100	Fittings	United Kingdom
WIS	Test Report acc WIS 4-32-14 Section 7.9	PE 100	Electrofusion couplers	United Kingdom

Modular system ELGEF® Plus

Less stock, higher flexibility, more variations – a contradiction? Not with the ELGEF Plus modular system. It is that easy:

Modular System Saddles

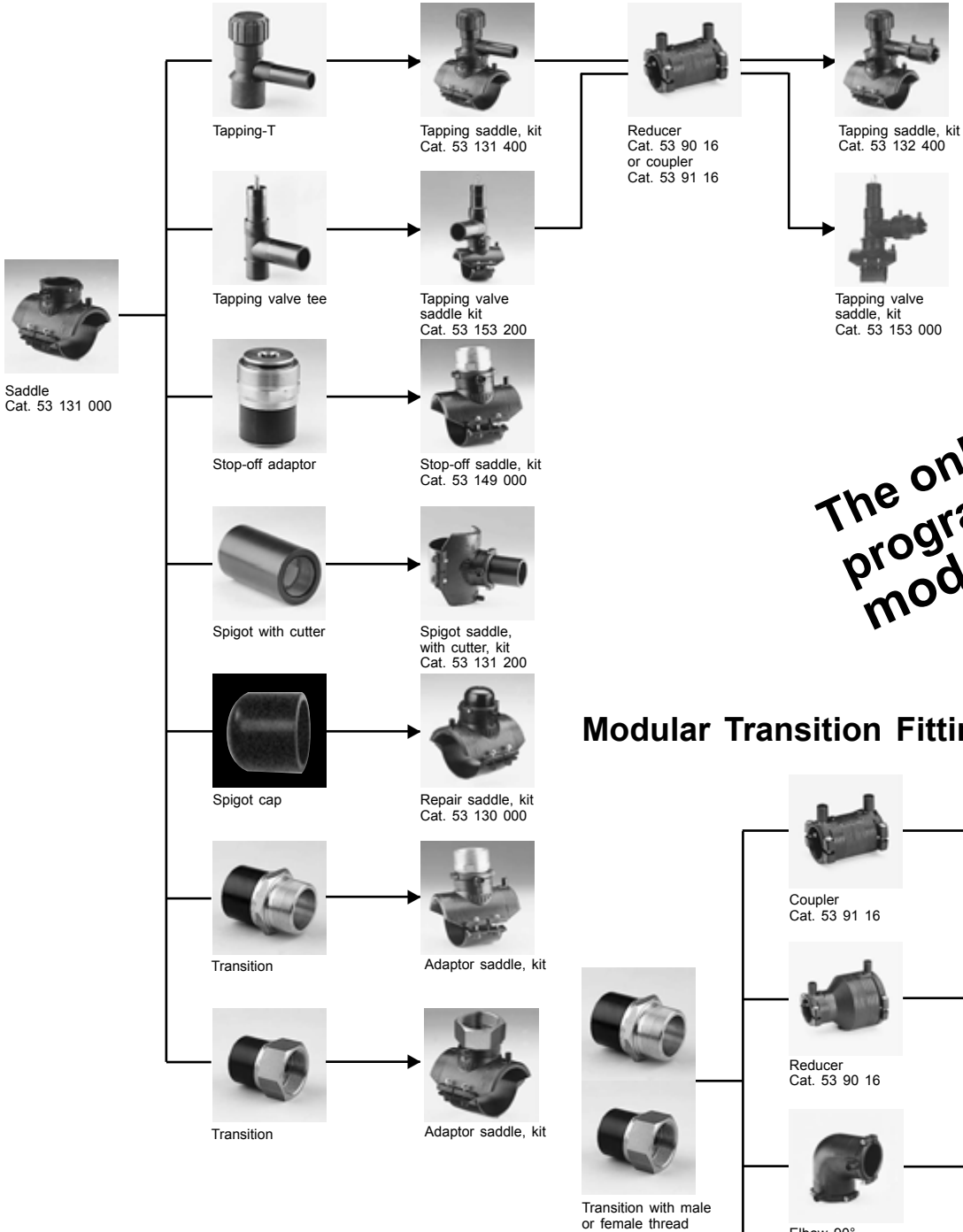

The only programme with a modular system

Modular Transition Fitting System

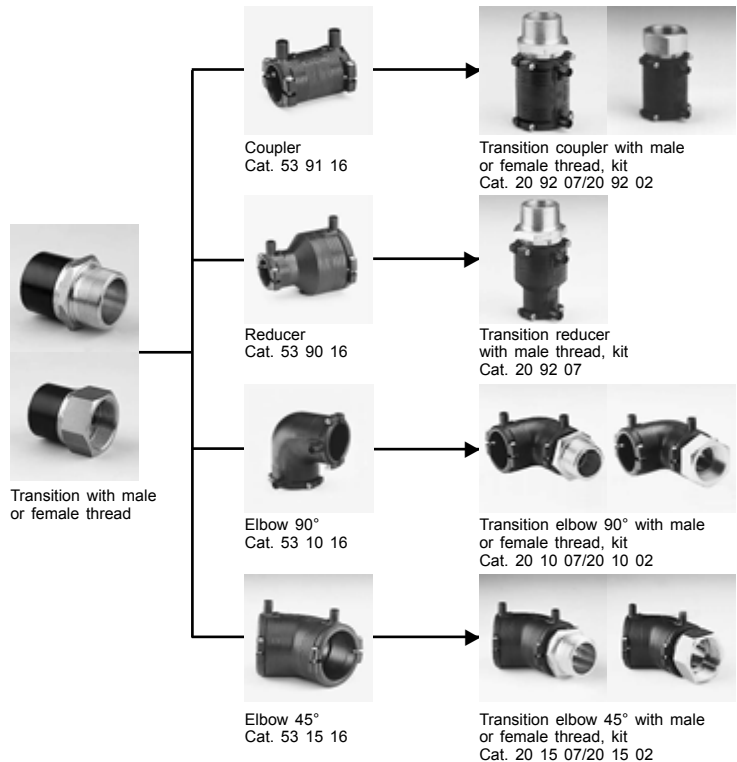

Electrofusion couplers and fittings

Technical data

Fusion compatibility

Next to the GF specifications for fusion compatibility the national regulations must be considered. The weakest component defines the max. allowable operating pressure.

All pipes must be in accordance with international regulations. The melt flow rate (MFR) must be between 0.2 and 1.4 g/10 min. National rules and regulations must be adhered to. All data given relates to PE 100 pipes.

Couplers (with integrated clamps from d20 – 63 mm) are used in conjunction with PE pipes and PE spigot fittings. Both socket outlets are fused simultaneously (mono-filament) on couplers ≤ d500 mm. Each socket is fused separately (bi-filament) for couplers of d560 mm and above. Couplers with flex groove design are bi-filament from ≥ d500 mm.

ELGEF Plus - electrofusion couplers SDR11

Pipe ø d [mm]	SDR9 ISO S4	SDR 11 ISO S5	SDR17/17.6 ISO S8	SDR 26 ISO S12.5	SDR 33 ISO S16
20	+	+			
25	+	+			
32	+	+			
40	+	+			
50	+	+	+		
63	+	+	+		
75	+	+	+	+	+
90	+	+	+	+	+
110	+	+	+	+	+
125	+	+	+	+	+
140	+	+	+	+	+
160	+	+	+	+	
180	+	+	+	+	
200	+	+	+	+	
225	+	+	+	+	
250	+	+	+	+	
280	+	+	+	+	
315	+	+	+	+	
355	+	+	+	+	
400	+	+	+	+	
450		+	+		
500		+	+		
560		+	+		
630		+	+		

+ suitable

+* conditionally suitable depending on temperature, pressure and medium, but only for water applications. Please contact your local GF contact.

+++ conditionally suitable depending on temperature, pressure and medium. Please contact your local GF contact.

ELGEF Plus - electrofusion couplers SDR17

Pipe ø d [mm]	SDR 11 ISO S5	SDR 17/17.6 ISO S8	SDR 26 ISO S12.5	SDR 33 ISO S16
160	+	+	+	+
180	+	+	+	+
200	+	+	+	+
225	+	+	+	+
250	+	+	+	+
280	+	+	+	+
315	+	+	+	+
355	+	+	+	+
400	+	+	+	+
450	+	+	+	+
500	+	+	+	+
560 (Monoring)	+	+	+	+
560 (Flex-groove)	+	+	+	
630 (Monoring)	+	+	+	+
630 (Flex-groove)	+	+	+	

+ suitable

+++ conditionally suitable depending on temperature, pressure and medium. Please contact your local GF contact.

ELGEF Plus - electrofusion fittings SDR11

Pipe ø d [mm]	SDR 11 ISO S5	SDR 17/17.6 ISO S8	SDR 26 ISO S12.5	SDR 33 ISO S16
20	+			
25	+			
32	+			
40	+			
50	+	+		
63	+	+		
75	+	+		
90	+	+	+	
110	+	+	+	
125	+	+	+	
160	+	+	+	
180	+	+	+	
200	+	+	+	
225	+	+	+	
250	+	+	+	

+ suitable

+++ conditionally suitable depending on temperature, pressure and medium. Please contact your local GF contact.

Insertion depth for couplers and fittings

d [mm]	Insertion depth L1 [mm]	
	SDR11	SDR17
20	34	
25	34	
32	36	
40	40	
50	44	
63	48	
75	55	
90	62	
110	72	
125	79	
140	84	
160	90	
180	95	
200	101	
225	110	
250	122	
280	126	
315	132	
355	122	
400	122	
450	160	145
500	178	145
560	193	196
560 (Flex-groove)		193
630	213	221
630 (Flex-groove)		213

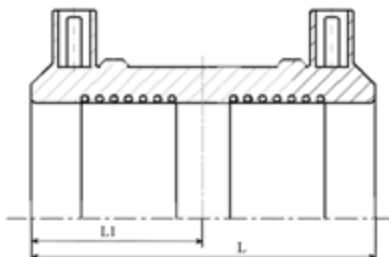

Minimum cooling time for couplers and fittings in minutes

d [mm]	SDR	Removal of clamp [min.]	Pressure test p ≤ 6 bar p ≤ 18 bar	
			[min.]	[min.]
20-63	11	6	10	30
75-110	11	10	20	60
125-160*	11	20	30	75
180-225**	11	20	45	90
250-315	11	30	60	150
355-400	11	45	90	150
*fittings d 160	11	30	45	90
**fittings d 180	11	30	60	90
450-630	11	60	90	150

p = test pressure

d [mm]	SDR	Removal of clamp [min.]	Pressure test p ≤ 6 bar p ≤ 18 bar	
			[min.]	[min.]
125-160	17	20	30	75
180-225	17	20	45	90
250-315	17	30	60	150
355-400	17	45	90	150
450-630	17	60	90	150

p = test pressure

Installation sequence up to d63 mm

NOTICE

Defective fusion connection

Insufficient preparations can lead to a defective fusion connection. The functionality and life-time of the product may be affected.

- Adhere to this installation manual, the data in the "Technical Manual for PE Piping Systems in Utilities" and the user manual for fusion units.

Required tools

- Pipe cutter
- Rotary peeler
- PE cleaner
- Lint-free, colourless and clean cloth
- Yardstick
- Permanent marker
- Screwdriver
- Fusion unit

Overview ELGEF Plus couplers, fittings and transition adaptors

¹ Insertion depth for couplers and fittings

d [mm]	Insertion depth L1 [mm]	
	SDR11	SDR17
20	34	
25	34	
32	36	
40	40	
50	44	
63	48	
75	55	
90	62	
110	72	
125	79	
140	84	
160		90
180		95
200		101
225		110
250		122
280		126
315		132
355		122
400		122
450		145
500		145
560		196
630		221

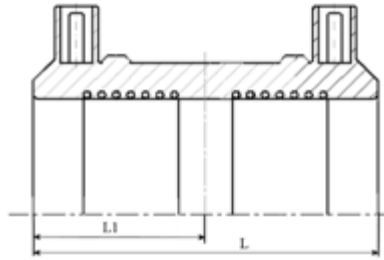

² Minimum cooling time for couplers and fittings in minutes

d [mm]	SDR	Removal of clamp [min.]	Pressure test p ≤ 6 bar p ≤ 18 bar	
			[min.]	[min.]
20-63	11	6	10	30
75-110	11	10	20	60
125-160*	11	20	30	75
180-225**	11	20	45	90
250-315	11	30	60	150
355-400	11	45	90	150
*fittings d 160	11	30	45	90
**fittings d 180	11	30	60	90

p = test pressure

d [mm]	SDR	Removal of clamp [min.]	Pressure test p ≤ 6 bar p ≤ 18 bar	
			[min.]	[min.]
125-160	17	20	30	75
180-225	17	20	45	90
250-315	17	30	60	150
355-400	17	45	90	150
450-630	17	60	90	150

p = test pressure

ELGEF Plus Electrofusion System

ELGEF Plus Couplers
ELGEF Plus Electrofusion fittings
ELGEF Plus Transition fittings



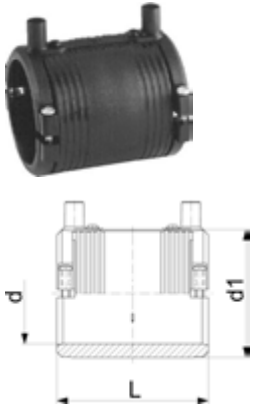

Coupler With integral pipe fixation

- PE 100 SDR 11 (ISO S5)
- 10 bar Gas / 16 bar Water
- 4 mm pin connectors
- Limited path fusion indicators
- Removable centre stop

d (mm)	Code	Weight (kg)	d1 (mm)	L (mm)
20	753 911 606	0.053	31	70
25	753 911 607	0.050	36	70
32	753 911 608	0.071	44	72
40	753 911 609	0.095	54	80
50	753 911 610	0.131	66	88
63	753 911 611	0.194	81	96



Coupler

- PE 100 SDR 11 (ISO S5)
- 10 bar Gas / 16 bar Water
- 4 mm pin connectors
- Limited path fusion indicators
- Removable centre stop up to d160

d (mm)	Code	Weight (kg)	d1 (mm)	L (mm)
75	753 911 612	0.282	96	110
90	753 911 613	0.406	113	125
110	753 911 614	0.692	138	145
125	753 911 615	0.718	154	156
140	753 911 616	0.945	172	166
160	753 911 617	1.362	196	180
180	753 911 618	1.747	219	192
200	753 911 619	1.866	244	208
225	753 911 620	3.329	273	225
250	753 911 621	4.678	304	248
280	753 911 622	7.500	340	252
315	753 911 623	8.142	382	267



Coupler

- PE 100 SDR 11 (ISO S5)
- 10 bar Gas / 16 bar Water
- 4 mm pin connectors
- Limited path fusion indicators
- With active reinforcement

d (mm)	Code	Weight (kg)	d1 (mm)	L (mm)
355	753 911 704	13.098	438	291
400	753 911 705	18.320	493	295
450	753 911 706	24.700	554	327
500	753 911 707	33.700	616	358
560	753 911 708	46.200	689	396
630	753 911 709	65.300	775	440
710	753 911 710	87.400	874	463
800	753 911 711	114.500	982	484



Coupler

- PE 100 SDR 11 (ISO S5)
- 16 bar Water
- Only for water applications
- 4 mm pin connectors

d (mm)	Code	Weight (kg)	d1 (mm)	L (mm)	SDR pipe
900	753 911 652	137.930	1110	550	11

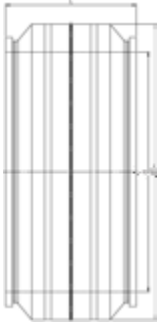



Coupler

- PE 100 SDR 17 (ISO S8)
- 5 bar Gas / 10 bar Water
- 4 mm pin connectors
- Limited path fusion indicators
- d160 with removable centre stop

d (mm)	Code	Weight (kg)	d1 (mm)	L (mm)
160	753 911 817	1.017	186	180
180	753 911 818	1.434	213	192
200	753 911 819	1.726	233	206
225	753 911 820	2.545	261	225
250	753 911 821	4.616	304	248
280	753 911 822	5.606	340	252
315	753 911 823	6.100	382	267



Coupler

- PE 100 SDR 17 (ISO S8)
- 5 bar Gas / 10 bar Water
- 4 mm pin connectors
- Limited path fusion indicators
- With active reinforcement

d (mm)	Code	Weight (kg)	d1 (mm)	L (mm)
355	753 911 804	9.522	416	291
400	753 911 805	18.000	467	295
450	753 911 806	16.000	526	327
500	753 911 807	22.000	584	358
560	753 911 808	34.000	647	396
630	753 911 809	35.000	727	440
710	753 911 810	55.600	820	463
800	753 911 811	73.000	922	484



Coupler

- PE 100 SDR 17 (ISO S8)
- 10 bar water
- Only for water applications
- 4 mm pin connectors

d (mm)	Code	Weight (kg)	d1 (mm)	L SDR pipe (mm)
900	753 911 852	93.150	1030	550 17
1000	753 911 853	125.650	1143	600 17
1200	753 911 854	196.450	1370	650 17





Coupler

- PE 100 SDR 26 (ISO S12.5)
- 6 bar water
- Only for water applications
- 4 mm pin connectors

d (mm)	Code	Weight (kg)	d1 (mm)	L (mm)	SDR pipe
710	753 911 950	31.920	797	360	26
800	753 911 951	42.800	897	380	26
900	753 911 952	57.580	1009	400	26
1000	753 911 953	79.270	1121	440	26
1200	753 911 954	125.700	1345	480	26

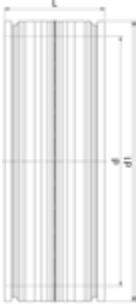



Elbow 90°
With integral pipe fixation

- PE 100 SDR 11 (ISO S5)
- 10 bar Gas / 16 bar Water
- 4 mm pin connectors
- Limited path fusion indicators

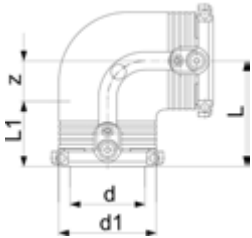

d (mm)	Code	Weight (kg)	d1 (mm)	L (mm)	L1 (mm)	z (mm)
20	753 101 606	0.080	35	54	34	20
25	753 101 607	0.068	35	54	34	20
32	753 101 608	0.098	44	53	36	17
40	753 101 609	0.141	54	62	39	23
50	753 101 610	0.200	66	71	43	28
63	753 101 611	0.318	81	81	48	32



Elbow 90°

- PE 100 SDR 11 (ISO S5)
- 10 bar Gas / 16 bar Water
- 4 mm pin connectors
- Limited path fusion indicators

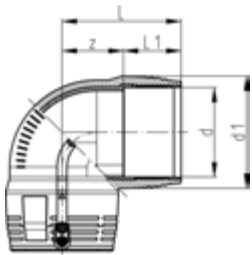

d (mm)	Code	Weight (kg)	d1 (mm)	L (mm)	L1 (mm)	z (mm)
75	753 101 612	0.415	97	94	54	40
90	753 101 813	0.828	115	122	62	60
110	753 101 814	1.224	140	147	72	76
125	753 101 815	1.742	160	155	77	68
160	753 101 817	3.830	196	191	92	103
180	753 101 818	5.410	219	210	96	114



Elbow 90°

- PE 100 SDR 11 (ISO S5)
- 10 bar Gas / 16 bar Water
- 4 mm pin connectors
- Limited path fusion indicators
- Two separate fusion zones

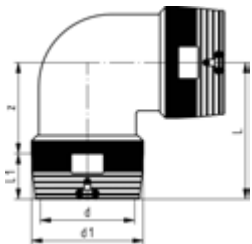

d (mm)	Code	Weight (kg)	d1 (mm)	L (mm)	L1 (mm)	z (mm)
200	753 101 819	9.320	250	298	104	194
225	753 101 820	13.220	280	318	112	206
250	753 101 821	16.600	310	347	123	224

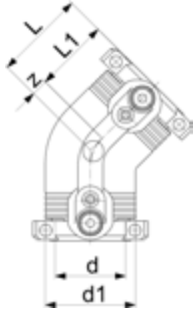

Elbow 45°
With integral pipe fixation

- PE 100 SDR 11 (ISO S5)
- 10 bar Gas / 16 bar Water
- 4 mm pin connectors
- Limited path fusion indicators

d (mm)	Code	Weight (kg)	d1 (mm)	L (mm)	L1 (mm)	z (mm)
32	753 151 608	0.075	44	44	36	8
40	753 151 609	0.106	54	50	39	11
50	753 151 610	0.171	66	56	43	13
63	753 151 611	0.252	81	63	48	15

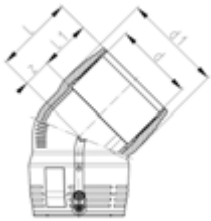

Elbow 45°

- PE 100 SDR 11 (ISO S5)
- 10 bar Gas / 16 bar Water
- 4 mm pin connectors
- Limited path fusion indicators

d (mm)	Code	Weight (kg)	d1 (mm)	L (mm)	L1 (mm)	z (mm)
75	753 151 612	0.332	97	71	54	17
90	753 151 813	0.583	115	91	62	29
110	753 151 814	0.985	140	112	72	40
125	753 151 815	1.438	160	119	78	49
160	753 151 817	3.055	196	135	92	42
180	753 151 818	4.037	217	144	95	47

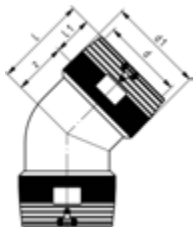

Elbow 45°

- PE 100 SDR 11 (ISO S5)
- 10 bar Gas / 16 bar Water
- 4 mm pin connectors
- Limited path fusion indicators
- Two separate fusion zones

d (mm)	Code	Weight (kg)	d1 (mm)	L (mm)	L1 (mm)	z (mm)
200	753 151 819	7.566	250	232	104	128
225	753 151 820	11.300	280	247	112	135
250	753 151 821	13.500	310	275	123	152

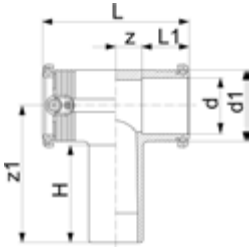

Tee 90° equal With integral pipe fixation

- PE 100 SDR 11 (ISO S5)
- 10 bar Gas / 16 bar Water
- 4 mm pin connectors
- Limited path fusion indicators

d (mm)	Code	Weight (kg)	d1 (mm)	L (mm)	L1 (mm)	z (mm)	z1 (mm)	H (mm)
20	753 211 606	0.085	35	88	32	11	92	67
25	753 211 607	0.075	35	90	32	11	92	70
32	753 211 608	0.118	44	102	34	15	100	74
40	753 211 609	0.175	54	119	39	21	114	82
50	753 211 610	0.252	66	135	42	24	126	90
63	753 211 611	0.407	81	151	46	28	150	102

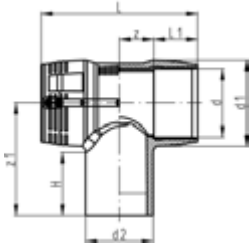

Tee 90° equal

- PE 100 SDR 11 (ISO S5)
- 10 bar Gas / 16 bar Water
- 4 mm pin connectors
- Limited path fusion indicators

d (mm)	Code	Weight (kg)	d1 (mm)	L (mm)	L1 (mm)	z (mm)	z1 (mm)	H (mm)
75	753 211 612	0.569	97	178	54	35	143	87
90	753 201 813	0.891	115	205	62	41	161	94
110	753 201 814	1.576	140	255	72	56	184	104
125	753 201 815	2.212	161	276	78	60	207	113
160	753 201 817	4.386	196	325	92	71	206	103
180	753 201 818	6.796	225	344	90	82	250	110

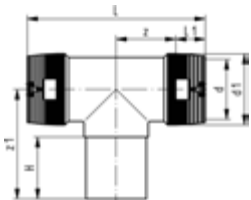

Tee 90° equal

- PE 100 SDR 11 (ISO S5)
- 10 bar Gas / 16 bar Water
- 4 mm pin connectors
- Limited path fusion indicators
- Two separate fusion zones

d (mm)	Code	Weight (kg)	d1 (mm)	L (mm)	L1 (mm)	z (mm)	z1 (mm)	H (mm)
200	753 201 819	10.800	250	590	104	191	250	117
225	753 201 820	15.900	280	636	112	206	270	122
250	753 201 821	18.900	310	685	123	220	288	127

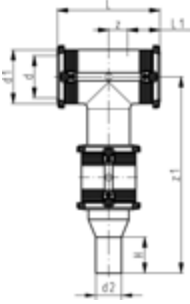

Tee 90° reduced (kit)

- PE 100 SDR 11 (ISO S5)
- 10 bar Gas / 16 bar Water
- Integral pipe fixation (up to d63)
- 4 mm pin connectors
- Limited path fusion indicators
- Supplied as kit including ELGEF Plus Coupler and Spigot Reducer

d (mm)	d2 (mm)	Code	Weight (kg)	d1 (mm)	L (mm)	L1 (mm)	z (mm)	z1 (mm)	H (mm)
40	20	193 281 004	0.314	54	120	39	21	244	212
40	25	193 281 005	0.319	54	120	39	21	244	212
75	40	193 280 998	1.060	97	187	61	33	296	248
90	50	193 280 999	1.655	112	202	61	41	336	274
110	63	193 280 961	2.812	136	242	65	56	366	293
125	63	193 280 963	3.673	151	256	75	53	361	279
125	110	193 280 965	3.920	151	256	75	53	389	307
180	90	193 281 032	10.891	225	344	90	82	487	347
180	110	193 281 033	10.465	225	344	90	82	495	355

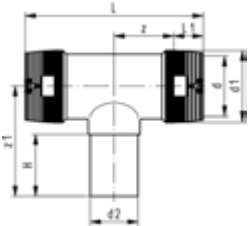

Tee 90° reduced

- PE 100 SDR 11 (ISO S5)
- 10 bar Gas / 16 bar Water
- 4 mm pin connectors
- Limited path fusion indicators
- Two separate fusion zones

d (mm)	d2 (mm)	Code	Weight (kg)	d1 (mm)	L (mm)	L1 (mm)	z (mm)	z1 (mm)	H (mm)
110	90	753 211 034	1.652	140	255	72	56	245	80
125	90	753 211 035	2.242	156	255	75	53	245	80
160	63	753 211 037	5.660	200	493	90	127	176	65
160	90	753 211 039	5.508	200	492	90	158	188	79
160	110	753 211 040	5.157	200	491	90	158	195	85
200	90	753 211 059	9.012	250	595	104	194	215	81
200	110	753 211 060	12.400	250	600	104	194	218	84
200	160	753 211 063	12.400	250	595	104	194	236	101
225	90	753 211 069	13.100	280	666	112	217	226	80
225	110	753 211 070	13.100	280	670	112	217	235	85
225	160	753 211 073	13.600	280	667	112	217	255	105
250	110	753 211 080	11.660	310	709	123	220	245	85
250	160	753 211 083	17.070	310	711	123	220	264	101

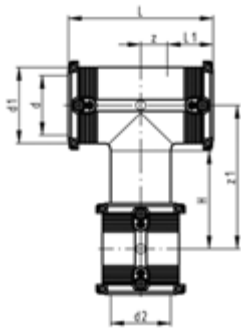

Tee 90° with weldable outlet (kit) Equal or reduced

- PE 100 SDR 11 (ISO S5)
- 10 bar Gas / 16 bar Water
- Integral pipe fixation (up to d63)
- 4 mm pin connectors
- Limited path fusion indicators
- Supplied as kit including ELGEF Plus Coupler or ELGEF Plus Reducer

d (mm)	d2 (mm)	Code	Weight (kg)	d1 (mm)	L (mm)	L1 (mm)	z (mm)	z1 (mm)	H (mm)
20	20	753 201 606	0.161	35	90	34	11	92	67
25	25	753 201 607	0.122	35	90	34	11	92	70
32	32	753 201 608	0.201	44	102	36	15	100	74
40	32	193 281 006	0.288	54	120	39	21	127	95
40	40	753 201 609	0.285	54	120	39	21	114	82
50	32	193 281 007	0.364	66	135	43	24	144	108
50	40	193 281 008	0.407	66	135	43	24	140	104
50	50	753 201 610	0.389	66	135	43	24	126	90
63	32	193 280 997	0.550	81	152	48	28	173	125
63	40	193 281 009	0.566	81	152	48	28	169	121
63	50	193 281 010	0.628	81	152	48	28	165	117
63	63	753 201 611	0.615	81	152	48	28	150	102
90	63	193 281 011	1.311	112	202	61	41	182	120
90	90	753 201 613	1.342	112	202	61	41	146	84
110	90	193 281 012	2.343	136	242	65	56	200	127
110	110	753 201 614	2.329	136	242	65	56	161	88
125	90	193 281 013	3.146	151	256	75	53	214	132
125	125	753 201 615	2.960	151	256	75	53	174	92
160	110	193 281 030	7.443	196	325	92	71	271	168
160	160	753 201 617	6.359	196	325	92	71	206	103
180	125	193 281 031	9.654	225	344	90	82	330	190
180	180	753 201 618	8.561	225	344	90	82	250	110



Reducer With integral pipe fixation

- PE 100 SDR 11 (ISO S5)
- 10 bar Gas / 16 bar Water
- 4 mm pin connectors
- Limited path fusion indicators

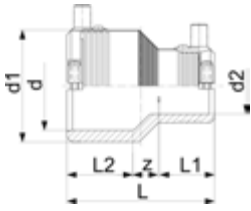

d (mm)	d2 (mm)	Code	Weight (kg)	d1 (mm)	L (mm)	L1 (mm)	L2 (mm)	z (mm)
25	20	753 901 639	0.051	35	74	34	34	6
32	20	753 901 640	0.056	44	79	33	36	10
32	25	753 901 641	0.062	44	79	33	36	10
40	20	753 901 644	0.069	54	88	33	39	15
40	25	753 901 645	0.084	54	88	33	39	15
40	32	753 901 646	0.095	54	88	33	39	13
50	32	753 901 651	0.124	66	96	35	43	18
50	40	753 901 652	0.119	66	96	39	43	14
63	32	753 901 656	0.158	81	105	35	48	23
63	40	753 901 657	0.176	81	105	39	48	19
63	50	753 901 658	0.176	81	105	43	48	15

Reducer



- PE 100 SDR 11 (ISO S5)
- 10 bar Gas / 16 bar Water
- 4 mm pin connectors
- Limited path fusion indicators

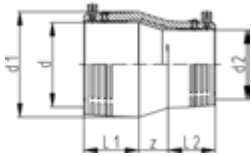

d (mm)	d2 (mm)	Code	Weight (kg)	d1 (mm)	L (mm)	L1 (mm)	L2 (mm)	z (mm)	Remarks
90	63	753 901 831	0.385	113	146	63	47	36	
110	63	753 901 832	0.644	140	184	71	58	55	in preparation
110	90	753 901 833	0.700	138	173	73	63	38	
125	90	753 901 836	0.891	152	180	79	61	40	
160	90	753 901 839	1.600	202	227	90	72	65	in preparation
160	110	753 901 864	1.783	202	226	90	71	65	
180	125	753 901 865	2.340	225	254	96	78	80	

Reducer



- PE 100 SDR 11 (ISO S5)
- 10 bar Gas / 16 bar Water
- 4 mm pin connectors
- Limited path fusion indicators
- Two separate fusion zones

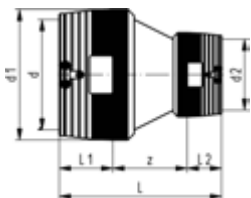

d (mm)	d2 (mm)	Code	Weight (kg)	d1 (mm)	L (mm)	L1 (mm)	L2 (mm)	z (mm)
200	160	753 901 837	5.098	250	365	104	90	171
225	160	753 901 838	6.000	280	385	112	90	183
225	200	753 901 845	8.200	280	400	112	104	184
250	160	753 901 840	7.860	310	400	123	90	187
250	200	753 901 841	8.480	310	417	123	104	200
250	225	753 901 842	8.450	310	430	123	112	204



Reducer (kit)

- PE 100 SDR 11 (ISO S5)
- 10 bar Gas / 16 bar Water
- Integral pipe fixation (up to d63)
- 4 mm pin connectors
- Limited path fusion indicators
- Supplied as kit including ELGEF Plus Coupler and Spigot Reducer

d (mm)	d2 (mm)	Code	Weight (kg)	d1 (mm)	L (mm)	L1 (mm)	L2 (mm)	z (mm)
75	40	193 280 992	0.574	96	265	55	40	170
75	50	193 280 993	0.623	96	269	55	44	170
75	63	193 280 994	0.700	96	273	55	48	170
90	50	193 280 958	0.857	113	297	63	44	190
90	75	193 280 995	1.071	113	308	63	55	190
110	75	193 280 996	1.496	138	333	73	55	205
125	63	193 280 953	1.567	154	314	79	48	187
125	110	193 280 951	2.098	154	367	79	73	215
160	125	193 280 952	3.252	196	414	90	79	245
180	110	193 280 959	4.167	214	413	95	73	245

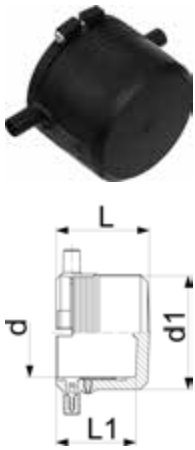

End cap With integral pipe fixation

- PE 100 SDR 11 (ISO S5)
- 10 bar Gas / 16 bar Water
- 4 mm pin connectors
- Limited path fusion indicators

d (mm)	Code	Weight (kg)	d1 (mm)	L (mm)	L1 (mm)
20	753 961 606	0.041	35	52	44
25	753 961 607	0.046	35	52	44
32	753 961 608	0.058	44	52	44
40	753 961 609	0.064	54	56	47
50	753 961 610	0.154	66	60	49
63	753 961 611	0.142	81	66	54

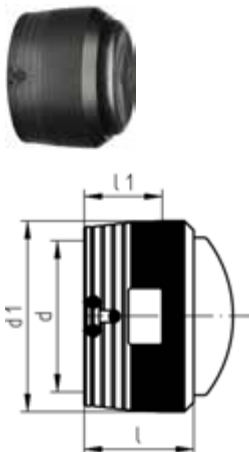

End cap

- PE 100 SDR 11 (ISO S5)
- 10 bar Gas / 16 bar Water
- 4 mm pin connectors
- Limited path fusion indicators

d (mm)	Code	Weight (kg)	d1 (mm)	L (mm)	L1 (mm)
160	753 961 617	1.782	200	143	90
200	753 961 619	3.585	250	162	104
225	753 961 620	4.500	280	170	112
250	753 961 621	6.300	310	185	123

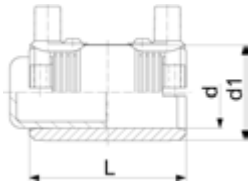

End cap (kit)

- PE 100 SDR 11 (ISO S5)
- 10 bar Gas / 16 bar Water
- 4 mm pin connectors
- Limited path fusion indicators
- Supplied as kit including ELGEF Plus Coupler

d (mm)	Code	Weight (kg)	d1 (mm)	L (mm)
75	753 961 712	0.446	96	110
90	753 961 713	0.663	113	125
110	753 961 714	1.090	133	145
125	753 961 715	1.345	155	158
140	753 961 716	2.250	175	170
160	753 961 717	2.382	197	180
180	753 961 718	3.098	220	194
200	753 961 719	4.180	245	208
225	753 961 720	5.852	296	224

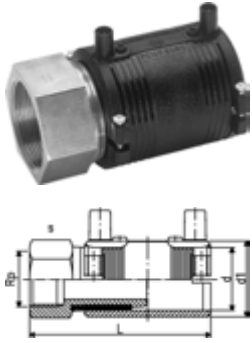

Transition coupler PE/steel (stainless 1.4305) Female thread

- PE 100 SDR 11 (ISO S5)
- 10 bar Gas / 16 bar Water
- With integral pipe fixation
- 4 mm pin connectors
- Limited path fusion indicators
- Supplied as a kit

d (mm)	Rp (inch)	Code	Weight (kg)	d1 (mm)	L (mm)	s (mm)
20	½	724 920 256	0.179	31	100	30
25	¾	724 920 257	0.231	36	101	35
32	1	724 920 258	0.319	44	108	40
40	1 ¼	724 920 259	0.480	54	118	50
50	1 ½	724 920 260	0.646	66	126	60
63	2	724 920 261	0.931	81	138	70

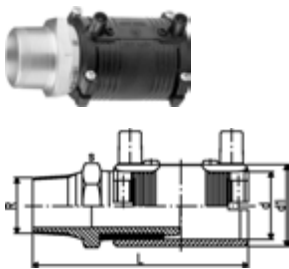

Transition coupler PE/steel (stainless 1.4305) Male thread

- PE 100 SDR 11 (ISO S5)
- 10 bar Gas / 16 bar Water
- With integral pipe fixation
- 4 mm pin connectors
- Limited path fusion indicators
- Delivered as a kit. Further combinations: modular system with threaded adapter and (150 228-1) reductions

d (mm)	R (inch)	Code	Weight (kg)	d1 (mm)	L (mm)	s (mm)
20	½	724 920 756	0.165	31	110	30
25	¾	724 920 757	0.249	36	111	35
32	1	724 920 758	0.332	44	117	40
40	1 ¼	724 920 759	0.464	54	127	50
40	1 ½	724 920 772	0.528	66	143	60
50	1 ½	724 920 760	0.611	66	135	60
63	1 ½	724 920 771	0.904	81	147	70
63	2	724 920 761	0.942	81	147	70



Transition coupler PE/brass (CW617N) With loose nut

- PE 100 SDR 11 (ISO S5)
- 16 bar Water
- With integral pipe fixation
- 4 mm pin connectors
- Limited path fusion indicators
- Delivered as a kit. Further combinations: modular system with threaded adapter and (150 228-1) reductions
- Incl. flat gasket for water applications (KTW / WRAS approved)

d (mm)	G (inch)	Code	Weight (kg)	d1 (mm)	d2 (mm)	L (mm)
25	¾	720 910 007	0.232	36	15	104
32	1	720 910 008	0.297	44	20	110
32	1 ½	720 910 028	0.480	44	22	114
50	1 ½	720 910 010	0.736	66	29	133
63	1	720 910 021	1.013	81	20	137
63	2	720 910 011	1.251	81	36	145

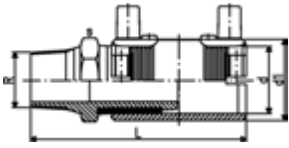

Transition coupler PE/brass (CW617N)
Male thread

- PE 100 SDR 11 (ISO S5)
- 10 bar Gas / 16 bar Water
- With integral pipe fixation
- 4 mm pin connectors
- Limited path fusion indicators
- Supplied as a kit

R (inch)	d (mm)	Code	Weight (kg)	d1 (mm)	L (mm)	s (mm)
½	20	720 920 756	0.187	31	110	30
1	20	720 920 754	0.344	44	124	40
¾	25	720 920 757	0.254	36	111	35
1	25	720 920 763	0.340	44	124	40
½	32	720 920 764	0.213	44	121	30
¾	32	720 920 765	0.268	44	122	35
1	32	720 920 758	0.340	44	117	40
1 ¼	32	720 920 766	0.489	54	135	50
1 ½	32	720 920 767	0.635	60	143	60
2	32	720 920 768	1.000	81	157	70
1	40	720 920 771	0.364	54	133	40
1 ¼	40	720 920 759	0.514	54	127	50
1 ½	40	720 920 772	0.645	66	143	60
2	40	720 920 773	0.961	81	157	70
1	50	720 920 776	0.367	66	141	40
1 ¼	50	720 920 777	0.554	66	143	50
1 ½	50	720 920 760	0.652	66	135	60
2	50	720 920 778	0.971	81	157	70
1	63	720 920 781	0.441	81	151	40
1 ¼	63	720 920 782	0.600	81	153	40
1 ½	63	720 920 783	0.712	81	153	60
2	63	720 920 761	0.943	81	147	70

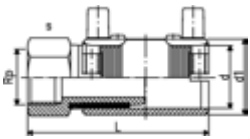

Transition coupler PE/brass (CW617N)
Female thread

- PE 100 SDR 11 (ISO S5)
- 10 bar Gas / 16 bar Water
- With integral pipe fixation
- 4 mm pin connectors
- Limited path fusion indicators
- Supplied as a kit

d (mm)	Rp (inch)	Code	Weight (kg)	d1 (mm)	L (mm)	s (mm)
32	1	720 920 258	0.306	44	108	40
40	1 ¼	720 920 259	0.496	54	118	50
50	1 ½	720 920 260	0.725	66	126	60
63	1	720 920 281	1.300	81	138	70
63	1 ¼	720 920 282	1.230	81	138	70
63	1 ½	720 920 283	1.134	81	138	70
63	2	720 920 261	1.057	81	138	70

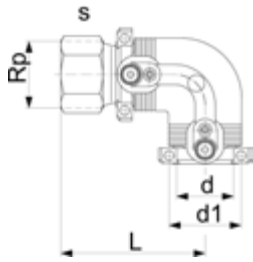

**Transition elbow 90° PE/steel (stainless 1.4305)
Female thread**

- PE 100 SDR 11 (ISO S5)
- 10 bar Gas / 16 bar Water
- With integral pipe fixation
- 4 mm pin connectors
- Limited path fusion indicators
- Supplied as a kit

d (mm)	Rp (inch)	Code	Weight (kg)	d1 (mm)	L (mm)	s (mm)
20	½	724 100 256	0.211	31	86	30
25	¾	724 100 257	0.237	36	87	35
32	1	724 100 258	0.320	44	89	40
40	1 ¼	724 100 259	0.545	54	100	50
50	1 ½	724 100 260	0.805	66	109	60
63	2	724 100 261	1.020	81	123	70

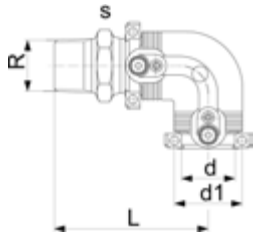

**Transition elbow 90° PE/steel (stainless 1.4305)
Male thread**

- PE 100 SDR 11 (ISO S5)
- 10 bar Gas / 16 bar Water
- With integral pipe fixation
- 4 mm pin connectors
- Limited path fusion indicators
- Supplied as a kit

d (mm)	R (inch)	Code	Weight (kg)	d1 (mm)	L (mm)	s (mm)
20	½	724 100 756	0.211	31	96	30
25	¾	724 100 757	0.230	36	97	35
32	1	724 100 758	0.324	44	98	40
40	1 ¼	724 100 759	0.560	54	109	50
40	1 ½	724 100 772	0.599	54	109	60
50	1 ½	724 100 760	0.701	66	118	60
63	1 ½	724 100 771	0.986	81	132	70
63	2	724 100 761	1.105	81	132	70

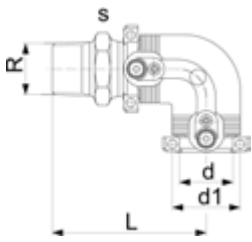

Transition elbow 90° PE/brass (CW617N)
Male thread

- PE 100 SDR 11 (ISO S5)
- 10 bar Gas / 16 bar Water
- With integral pipe fixation
- 4 mm pin connectors
- Limited path fusion indicators
- Supplied as a kit

d (mm)	R (inch)	Code	Weight (kg)	d1 (mm)	L (mm)	s (mm)
20	½	720 100 756	0.240	31	96	30
25	¾	720 100 757	0.260	36	97	35
32	1	720 100 758	0.368	44	98	40
32	1 ¼	720 100 766	0.500	44	100	50
32	1 ½	720 100 767	0.562	44	100	60
40	1	720 100 771	0.511	54	107	50
40	1 ¼	720 100 759	0.534	54	109	50
40	1 ½	720 100 772	0.615	54	109	60
50	1	720 100 776	0.677	66	116	60
50	1 ¼	720 100 777	0.771	66	118	60
50	1 ½	720 100 760	0.734	66	118	60
63	1 ¼	720 100 782	1.040	81	128	70
63	1 ½	720 100 783	1.039	81	128	70
63	2	720 100 761	1.108	81	132	70

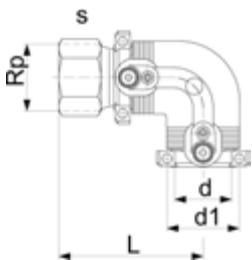

Transition elbow 90° PE/brass (CW617N)
Female thread

- PE 100 SDR 11 (ISO S5)
- 10 bar Gas / 16 bar Water
- With integral pipe fixation
- 4 mm pin connectors
- Limited path fusion indicators
- Supplied as a kit

d (mm)	Rp (inch)	Code	Weight (kg)	d1 (mm)	L (mm)	s (mm)
32	1	720 100 258	0.359	44	89	40
40	1 ¼	720 100 259	0.525	54	100	50
50	1 ½	720 100 260	0.825	66	109	60
63	1	720 100 281	1.420	81	123	70
63	1 ¼	720 100 282	1.391	81	123	70
63	1 ½	720 100 283	1.305	81	123	70
63	2	720 100 261	1.165	81	123	70

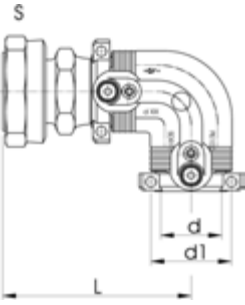

Transition elbow 90° PE/brass (CW617N) With loose nut

- PE 100 SDR 11 (ISO S5)
- 16 bar Water
- With integral pipe fixation
- 4 mm pin connectors
- Limited path fusion indicators
- Supplied as a kit
- Incl. flat gasket for water applications (KTW / WRAS approved)

d (mm)	Rp (inch)	Code	Weight (kg)	d1 (mm)	L (mm)
25	¾	720 100 007	0.240	36	90
32	1	720 100 008	0.347	44	91
32	1 ¼	720 100 018	0.490	44	95
50	1 ½	720 100 010	0.850	66	116
63	1	720 100 021	1.114	81	121
63	2	720 100 011	1.375	81	129



Transition fittings PE/steel

- PE 100 SDR 11 (ISO S5)
- 8 bar Gas / 16 bar Water
- **Suitable for 10 bar Gas / 16 bar Water
- Electrofusion weldable
- PE coated for corrosion resistance
- * Steel pipe galvanized

	d (mm)	d1 (inch)	Code	Weight (kg)	L (mm)	L1 (mm)	L2 (mm)
*	20	½	775 641 502	0.450	427	35	41
	25	¾	775 641 507	0.658	462	35	41
	32	1	775 641 510	0.988	462	35	44
	40	1 ¼	775 641 514	1.208	470	35	49
	50	1 ½	775 641 518	1.355	475	35	55
	63	2	775 641 524	2.011	480	35	63
	75	2 ½	775 641 632	2.983	545	35	70
	90	3	775 641 636	3.762	562	45	79
	110	3	775 641 640	4.381	580	45	82
	110	4	775 641 641	6.633	580	45	82
	125	4	775 641 645	6.833	584	45	87
	160	6	775 641 655	12.406	607	45	98
	180	6	775 641 659	11.935	605	45	105
	200	8	775 642 664	19.647	615	45	112
	225	8	775 642 669	20.154	620	45	120
	250	8	775 642 665	21.354	640	45	129
**	250	10	775 642 666	30.000	645	45	129
**	280	10	775 642 673	31.000	637	45	139
**	315	12	775 642 672	35.000	730	45	150
**	355	12	775 642 675	49.000	732	45	164
**	400	16	775 642 678	94.000	770	45	179

ELGEF Plus Electrofusion System

ELGEF Plus Branch Fitting
ELGEF Plus Modular System
ELGEF Plus Saddles/Valves



ELGEF Plus saddles and valves

ELGEF Plus modular system

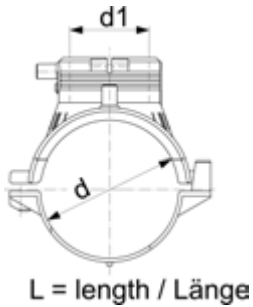

Electrofusion saddle

- PE 100 SDR 11 (ISO S5)
 - 10 bar Gas / 16 bar Water
 - Complete with lower part
 - 4 mm pin connectors
 - Limited path fusion indicators
 - * Complete with moulded-on lower part
 - **Delivery without lower part for assembling as Top Load with tool no. 799.350.477
- Not suitable for all tapping-tees, tapping-valves and spigots with cutter of the modular systems; SDR compatibility according to individual parts

	d (mm)	d1 (mm)	Code	Weight (kg)	L (mm)
	63	63	193 131 037	0.325	165
	75	63	193 131 047	0.455	165
	90	63	193 131 057	0.415	165
	110	63	193 131 067	0.458	165
*	110	63	193 133 067	0.490	182
	125	63	193 131 077	0.502	165
	140	63	193 131 087	0.523	165
	160	63	193 131 097	0.493	165
*	160	63	193 133 097	0.543	182
	180	63	193 131 107	0.600	165
	200	63	193 131 117	0.634	165
	225	63	193 131 127	0.618	165
	250	63	193 131 137	0.627	165
**	280	63	193 131 147	0.359	165
**	315 - 355	63	193 131 157	0.373	165
**	400	63	193 131 177	0.356	165

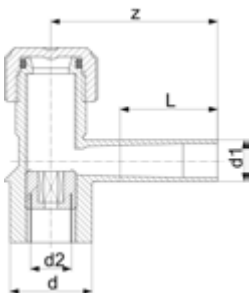

Tapping tee

- PE 100 SDR 11 (ISO S5)
- 10 bar Gas / 16 bar Water
- With integrated cutter to tap live mains under pressure
- Long fusion outlet
- O-ring-sealed screw cap
- For ELGEF Plus Branch Saddle d63-225mm, pipe SDR 11
- For ELGEF Plus Branch Saddle d90-315mm, pipe SDR 17
- *For ELGEF Plus Branch Saddle d250-315mm, pipe SDR 11 and d250-400mm, pipe SDR 17
- **For ELGEF Plus Branch Saddle d110 - 225mm, pipe SDR11 and d110 - 315mm, pipe SDR17

	d (mm)	d1 (mm)	Code	Weight (kg)	d2 (mm)	L (mm)	z (mm)	SW (mm)
	63	20	193 280 358	0.380	32	69	130	17
	63	25	193 280 359	0.375	32	70	130	17
	63	32	193 280 184	0.377	32	76	130	17
	63	40	193 280 360	0.396	32	81	137	17
	63	63	193 280 185	1.099	32	100	160	17
*	63	63	193 280 711	1.120	35	100	160	17
**	63	63	193 280 290	1.086	41	100	160	17



Tapping tee With electrofusion cap

- PE 100 SDR 11 (ISO S5)
- 10 bar Gas / 16 bar Water
- With integrated cutter to tap live mains under pressure
- For ELGEF Plus Branch Saddle d63-225mm, pipe SDR 11
- For ELGEF Plus Branch Saddle d90-315mm, pipe SDR 17
- Long fusion outlet

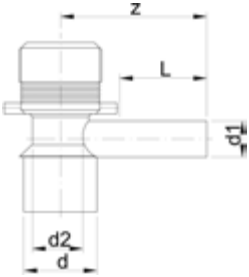

d (mm)	d1 (mm)	Code	Weight (kg)	d2 (mm)	D2 (mm)	L (mm)	z (mm)	SW (mm)
63	32	193 280 300	0.441	32	32	76	130	17
63	63	193 280 301	1.209	32	32	100	160	17



Electrofusion cap

- PE 100 SDR 11 (ISO S5)
- 10 bar Gas / 16 bar Water
- For ELGEF Plus Tapping Saddles
- 193 280 153 is suitable for all Tapping Tees with outlets d20, d25, d32, d40 mm
- 193 280 154 is suitable for all Tapping Tees with d63 mm outlet

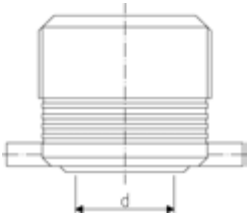

d (mm)	Code	Weight (kg)
55	193 280 153	0.126
68	193 280 154	0.200

Tapping valve tee

- PE 100 SDR 11 (ISO S5)
- 10 bar Gas / 16 bar Water
- With integrated cutter to tap live mains under pressure
- For ELGEF Plus Branch Saddle d63 - 250, pipe SDR11
- For ELGEF Plus Branch Saddle d75 - 315mm, pipe SDR 17 and d250 - 400mm, pipe SDR 26
- Spindle size (SW) 14
- Number of turns to fully open or close valve is 13 for outlet d32
- Number of turns to fully open or close valve is 28 for outlet d63
- Long fusion outlet

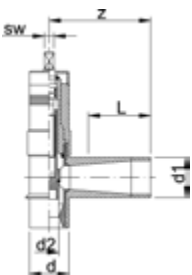

d (mm)	d1 (mm)	Code	Weight (kg)	d2 (mm)	L (mm)	z (mm)
63	32	193 281 605	1.493	21	70	127
63	63	193 281 606	2.361	31	100	160

Stop-off adaptor with brass plug



- PE 100 SDR 11 (ISO S5)
- 10 bar Gas / 16 bar Water
- For ELGEF Plus Branch Saddle d63 - 400mm, pipe SDR 11
- For main dimension d63 and d75mm we recommend a maximum cutting diameter of d = 39mm
- Stop-Off insert (CW617N) and plug

d	Rp	Code	Weight	d1	L	z	SW
(mm)	(inch)		(kg)	(mm)	(mm)	(mm)	(mm)
63	2 ½	193 280 274	1.462	50.0	93	46	19
63	2 ½	193 280 294	1.375	56.5	93	46	19

Stop-off adaptor PE

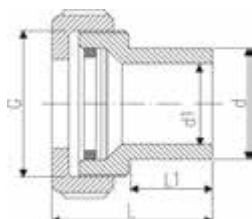

- PE 100 SDR 11 (ISO S5)
- 10 bar Gas / 16 bar Water
- For ELGEF Plus Branch Saddle d63 - 400mm, pipe SDR 11, d75 - 400mm, pipe SDR 17
- PE Stop-Off insert d 63
- Plug with rubber seal
- PVP nut
- For main dimension d63 and d75mm we recommend a maximum cutting diameter of d = 39mm

d	G	Code	Weight	d1	L	z
(mm)	(inch)		(kg)	(mm)	(mm)	(mm)
63	2 ¾	193 280 279	0.254	51	87	45

Spigot with cutter

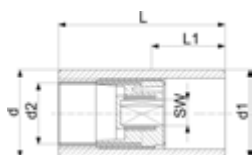

- PE 100 SDR 11 (ISO S5)
- 10 bar Gas / 16 bar Water
- For ELGEF Plus Branch Saddle d63-225mm, pipe SDR 11
- For ELGEF Plus Branch Saddle d75 - 315mm, pipe SDR 17 and d250 - 400mm, pipe SDR 26

d	d1	Code	Weight	d2	L	L1	SW
(mm)	(mm)		(kg)	(mm)	(mm)	(mm)	(mm)
63	32	193 280 272	0.144	19	113	50	13
63	63	193 280 273	0.692	32	120	50	17

Transition adaptor PE/brass (CW617N) Male thread

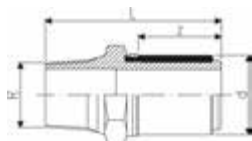

- PE 100 SDR 11 (ISO S5)
- 10 bar Gas / 16 bar Water
- Only for ELGEF Plus Couplers and Fittings

d	R	Code	Weight	L	z
(mm)	(inch)		(kg)	(mm)	(mm)
20	½	720 920 706	0.133	75	33
25	¾	720 920 707	0.182	76	33
32	1	720 920 708	0.257	80	35
32	1 ¼	720 920 718	0.370	82	35
32	1 ½	720 920 728	0.437	82	35
40	1	720 920 719	0.358	84	39

table continued on the next page

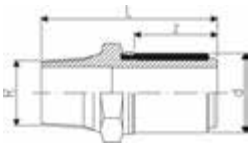

d (mm)	R (inch)	Code	Weight (kg)	L (mm)	z (mm)
40	1 ¼	720 920 709	0.405	86	39
40	1 ½	720 920 729	0.454	86	39
50	1	720 920 720	0.505	88	43
50	1 ¼	720 920 730	0.539	90	43
50	1 ½	720 920 710	0.514	90	43
63	1 ¼	720 920 721	0.739	94	47
63	1 ½	720 920 731	0.709	94	47
63	2	720 920 711	0.762	98	47

Transition adaptor PE/brass (CW617N) Female thread



- PE 100 SDR 11 (ISO S5)
- 10 bar Gas / 16 bar Water
- Only for ELGEF Plus Couplers and Fittings

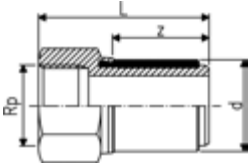

d (mm)	Rp (inch)	Code	Weight (kg)	L (mm)	z (mm)
32	1	720 920 208	0.250	71	35
40	1 ¼	720 920 209	0.386	77	39
50	1 ½	720 920 210	0.594	81	43
63	1	720 920 221	1.100	89	47
63	1 ¼	720 920 231	1.062	89	47
63	1 ½	720 920 241	0.958	89	47
63	2	720 920 211	0.832	89	47

Transition adaptor PE/brass Loose nut (CW617N)



- PE 100 SDR 11 (ISO S5)
- 16 bar Water
- Only for ELGEF Plus Couplers and Fittings
- Incl. flat gasket for water applications (KTW / WRAS approved)

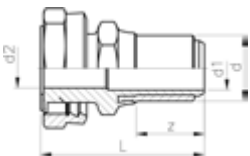

d (mm)	G (inch)	Code	Weight (kg)	d2 (mm)	L (mm)	z (mm)
25	¾	720 920 007	0.152	15	68	32
32	1	720 920 008	0.235	20	72	34
32	1 ¼	720 920 018	0.356	22	76	34
50	1 ½	720 920 010	0.584	29	87	42
63	1	720 920 021	0.804	20	87	46
63	2	720 920 011	1.018	36	95	46

Transition adaptor PE/steel (stainless 1.4305) Male thread



- PE 100 SDR 11 (ISO S5)
- 10 bar Gas / 16 bar Water
- Only for ELGEF Plus Couplers and Fittings

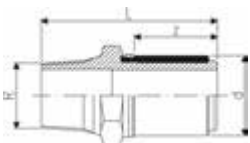

d (mm)	R (inch)	Code	Weight (kg)	L (mm)	z (mm)
20	½	724 920 706	0.120	75	33
25	¾	724 920 707	0.179	76	33
32	1	724 920 708	0.244	80	35
40	1 ¼	724 920 709	0.380	86	39

table continued on the next page

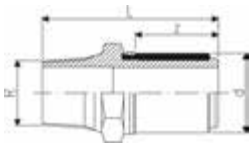

d (mm)	R (inch)	Code	Weight (kg)	L (mm)	z (mm)
40	1 ½	724 920 719	0.446	86	39
50	1 ½	724 920 710	0.478	90	43
63	1 ½	724 920 721	0.653	98	47
63	2	724 920 711	0.722	98	47



Transition adaptor PE/steel (stainless 1.4305) Female thread

- PE 100 SDR 11 (ISO S5)
- 10 bar Gas / 16 bar Water
- Only for ELGEF Plus Couplers and Fittings

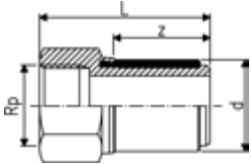

d (mm)	Rp (inch)	Code	Weight (kg)	L (mm)	z (mm)
20	½	724 920 206	0.128	65	33
25	¾	724 920 207	0.181	66	33
32	1	724 920 208	0.237	71	35
40	1 ¼	724 920 209	0.373	77	39
50	1 ½	724 920 210	0.527	81	43
63	2	724 920 211	0.733	89	47



PE adaptor Female thread

- PE 80 SDR 11 (ISO S5)
- 5 bar Gas / 12,5 bar Water
- Connection to plastic or metal
- Reinforcing ring stainless (A2)
- For ELGEF Plus Branch Saddle d63 - 400mm, pipe SDR 11, d75 - 400mm, pipe SDR 17
- Parallel female thread
- *PE 100 SDR 11 (ISO S5)
- *5 bar Gas / 16 bar Water



	d (mm)	Rp (inch)	Code	Weight (kg)	L (mm)
*	63	½	193 281 617	0.060	68
	63	1 ½	173 281 925	0.088	54

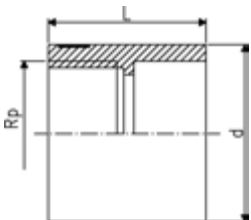



Repair saddle

- PE 100 SDR 11 (ISO S5)
- 10 bar Gas / 16 bar Water
- Complete with lower part
- 4 mm pin connectors
- Limited path fusion indicators
- Supplied as kit including Spigot Cap (753.961.011)
- *Delivery without lower part for assembling as Top Load with tool no. 799.350.477

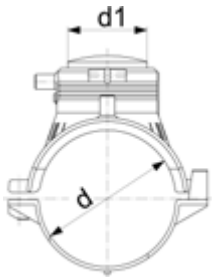

L = length / Länge

	d (mm)	d1 (mm)	Code	Weight (kg)	L (mm)
	63	63	193 130 037	0.417	165
	75	63	193 130 047	0.574	165
	90	63	193 130 057	0.513	165
	110	63	193 130 067	0.565	165
	125	63	193 130 077	0.622	165
	140	63	193 130 087	0.660	165
	160	63	193 130 097	0.589	165
	180	63	193 130 107	0.733	165
	200	63	193 130 117	0.731	165
	225	63	193 130 127	0.708	165
	250	63	193 130 137	0.640	165
*	280	63	193 130 147	0.450	165
*	315 - 355	63	193 130 157	0.443	165
*	400	63	193 130 177	0.450	165

Reinforcing saddle



- PE 100 SDR 11 (ISO S5)
- 10 bar Gas / 16 bar Water
- **Fusion voltage 24 Volt**
- 4 mm pin connectors
- For use as a repair saddle with PE repair plug (Code 799.199.088 and 799.199.089) and as reinforcing saddle with an fusion area which extends the whole circumference of the pipe
- Use Spring clamp (Code 799.150.090) for installation

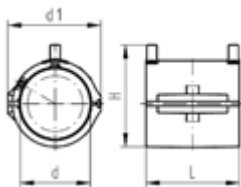

d (mm)	Code	Weight (kg)	d1 (mm)	L (mm)	H (mm)
40	193 127 017	0.135	104	105	108
50	193 127 027	0.200	80	105	85
63	193 127 037	0.255	132	120	153
75	193 127 047	0.430	162	130	122
90	193 127 057	0.547	104	130	147
110	193 127 067	0.528	120	120	191
125	193 127 077	0.757	158	130	184
160	193 127 097	0.961	192	130	218
180	193 127 107	1.095	214	130	239
200	193 127 117	1.145	236	130	260
225	193 127 127	1.399	262	140	286



Stop-off saddle with PE-adaptor
Maximum passage 50 mm

- PE 100 SDR 11 (ISO S5)
- 10 bar Gas / 16 bar Water
- Complete with lower part
- Supplied as Kit with PE-Stop-Off Adaptor
- PE Stop-Off insert
- 4 mm pin connectors
- Limited path fusion indicators
- *Delivery without lower part for assembling as Top Load with tool no. 799.350.477; angle adaptor (799.350.340) for fusion cable required

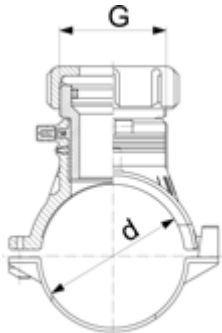

L = length / Länge

	d (mm)	G (inch)	Code	Weight (kg)	L (mm)
	63	2 3/4	193 149 237	0.606	165
	75	2 3/4	193 149 247	0.765	165
	90	2 3/4	193 149 257	0.696	165
	110	2 3/4	193 149 267	0.732	165
	125	2 3/4	193 149 277	0.785	165
	140	2 3/4	193 149 287	0.820	165
	160	2 3/4	193 149 297	0.772	165
	180	2 3/4	193 149 307	0.920	165
	200	2 3/4	193 149 317	0.913	165
	225	2 3/4	193 149 327	0.910	165
	250	2 3/4	193 149 337	0.936	165
*	280	2 3/4	193 149 347	0.920	165
*	315 - 355	2 3/4	193 149 357	0.660	165
*	400	2 3/4	193 149 377	0.920	165

Stop-off saddle (kit)
Maximum passage 56.5 mm



- PE 100 SDR 11 (ISO S5)
- 10 bar Gas / 16 bar Water
- Complete with lower part
- Stop-Off insert (CW617N) and plug
- 4 mm pin connectors
- Limited path fusion indicators
- Stop-Off insert with outside thread Rp 2 1/2" and internal thread Rp 2" suited for common tapping devices permitting "gas-tight" installation
- *Delivery without lower part for assembling as Top Load with tool no. 799.350.475; angle adaptor (799.350.340) for fusion cable required
- For main dimension d63 and d75mm we recommend a maximum cutting diameter of d = 39mm

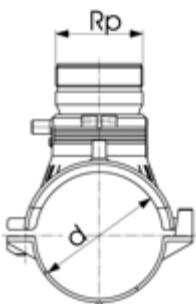

L = length / Länge

	d (mm)	Rp (inch)	Code	Weight (kg)	L (mm)
	63	2 1/2	193 149 437	1.770	165
	75	2 1/2	193 149 447	1.900	165
	90	2 1/2	193 149 457	1.775	165
	110	2 1/2	193 149 467	1.788	165
	125	2 1/2	193 149 477	1.923	165
	140	2 1/2	193 149 487	1.945	165
	160	2 1/2	193 149 497	1.861	165
	180	2 1/2	193 149 507	2.017	165
	200	2 1/2	193 149 517	2.092	165
	225	2 1/2	193 149 527	2.031	165
	250	2 1/2	193 149 537	2.058	165
*	280	2 1/2	193 149 547	1.550	165
*	315 - 355	2 1/2	193 149 557	1.770	165
*	400	2 1/2	193 149 577	1.550	165

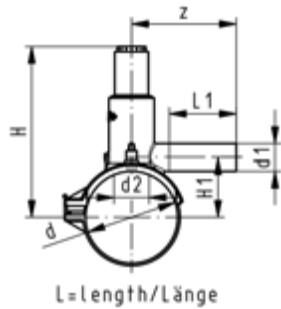

Tapping saddle Monobloc version

- PE 100 SDR 11 (ISO S5)
- 10 bar Gas / 16 bar Water
- With integrated cutter to tap live mains under pressure
- Complete with moulded-on lower part
- 4 mm pin connectors
- Limited path fusion indicators
- Long fusion outlet
- O-ring-sealed screw cap
- *Compatible with GASSTOP type GS

	d (mm)	d1 (mm)	Code	Weight (kg)	d2 (mm)	H (mm)	H1 (mm)	L (mm)	L1 (mm)	z (mm)
*	63	20	193 131 932	0.368	25	146	44	144	76	110
	63	25	193 131 933	0.393	25	146	44	144	76	110
*	63	32	193 131 934	0.376	25	146	44	144	76	110
*	90	20	193 131 952	0.494	32	198	61	162	76	115
	90	25	193 131 953	0.503	32	198	61	162	76	115
*	90	32	193 131 954	0.505	32	198	61	162	76	115
	90	63	193 131 957	0.667	32	198	61	162	76	115
*	110	20	193 131 962	0.560	32	208	71	162	76	115
	110	25	193 131 963	0.570	32	208	71	162	76	115
*	110	32	193 131 964	0.574	32	208	71	162	76	125
	110	63	193 131 967	0.684	32	208	71	162	100	160
*	125	20	193 131 972	0.562	32	216	79	162	76	120
	125	25	193 131 973	0.552	32	216	79	162	76	120
*	125	32	193 131 974	0.574	32	216	79	162	76	120
	125	63	193 131 977	0.704	32	216	79	162	76	120
*	160	20	193 131 992	0.631	32	233	96	162	76	120
	160	25	193 131 993	0.641	32	233	96	162	76	125
*	160	32	193 131 994	0.648	32	233	96	162	76	130
	160	63	193 131 997	0.794	32	233	96	162	100	170

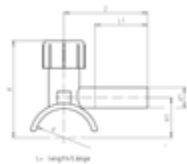

Tapping saddle Monobloc

- PE 100 SDR 11 (ISO S5)
- 10 bar Gas / 16 bar Water
- With integrated cutter to tap live mains under pressure
- Complete with lower part
- 4 mm pin connectors
- Fusion indicator
- Long fusion outlet
- O-ring-sealed screw cap

	d (mm)	d1 (mm)	Code	Weight (kg)	d2 (mm)	H (mm)	H1 (mm)	L (mm)	L1 (mm)	z (mm)
	32	20	193 281 459	0.156	12	83	29	101	65	90

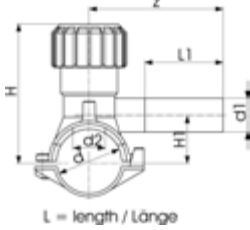

Tapping saddle Monobloc version

- PE 100 SDR 11 (ISO S5)
- 10 bar Gas / 16 bar Water
- With integrated cutter to tap live mains under pressure
- Complete with lower part
- 4 mm pin connectors
- Limited path fusion indicators
- Long fusion outlet
- O-ring-sealed screw cap

d	d1	Code	Weight	d2	H	H1	L	L1	z
(mm)	(mm)		(kg)	(mm)	(mm)	(mm)	(mm)	(mm)	(mm)
40	20	193 131 412	0.225	16	99	33	103	70	102
40	25	193 131 413	0.226	16	99	33	103	70	102
40	32	193 131 414	0.225	16	99	33	103	70	120
50	20	193 131 422	0.214	16	104	38	103	70	102
50	25	193 131 423	0.212	16	104	38	103	70	102
50	32	193 131 424	0.228	16	104	38	103	70	120
63	20	193 131 432	0.428	25	134	44	126	70	115
63	25	193 131 433	0.431	25	134	44	126	70	115
63	32	193 131 434	0.425	25	134	44	126	70	130

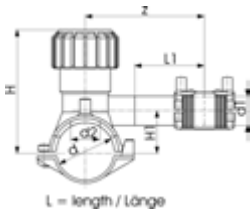

Tapping saddle (kit) Monobloc version

- PE 100 SDR 11 (ISO S5)
- 10 bar Gas / 16 bar Water
- With integrated cutter to tap live mains under pressure
- Complete with lower part
- 4 mm pin connectors
- Limited path fusion indicators
- Long fusion outlet
- O-ring-sealed screw cap
- Supplied as Kit with enclosed service line fitting (ELGEF Plus Coupler or Reducer)

d	d1	Code	Weight	d2	H	H1	L	L1	z
(mm)	(mm)		(kg)	(mm)	(mm)	(mm)	(mm)	(mm)	(mm)
40	20	193 132 412	0.278	16	99	33	103	70	102
40	25	193 132 413	0.289	16	99	33	103	70	102
40	32	193 132 414	0.284	16	99	33	103	70	120
50	20	193 132 422	0.325	16	105	38	103	70	102
50	25	193 132 423	0.273	16	105	38	103	70	102
50	32	193 132 424	0.296	16	105	38	103	70	120
63	20	193 132 432	0.486	25	134	44	126	70	115
63	25	193 132 433	0.492	25	134	44	126	70	115
63	32	193 132 434	0.507	25	134	44	126	70	130
63	40	193 132 435	0.461	25	134	44	126	70	130



Tapping saddle (kit)
With 360° rotatable outlet

- PE 100 SDR 11 (ISO S5)
- 10 bar Gas / 16 bar Water
- With integrated cutter to tap live mains under pressure
- Complete with lower part
- 4 mm pin connectors
- Limited path fusion indicators
- Long fusion outlet
- O-ring-sealed screw cap
- Supplied as Kit with enclosed service line fitting (ELGEF Plus Coupler or Reducer)
- d315 - 400 mm: application is limited on pipes d355 and d400 mm. Not suitable for pipes if larger wall thickness than SDR 17 pipes.
- *Delivery without lower part for assembling as Top Load with tool no. 799.350.477; angle adaptor (799.350.340) for fusion cable required

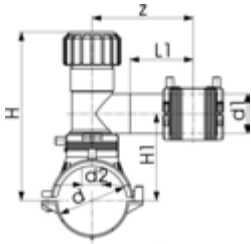
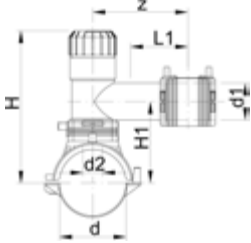

L = length / Länge

d	d1	Code	Weight	d2	H	H1	L	L1	z
(mm)	(mm)		(kg)	(mm)	(mm)	(mm)	(mm)	(mm)	(mm)
63	20	193 132 402	0.754	32	186	108	165	76	130
63	25	193 132 403	0.761	32	186	108	165	76	130
63	32	193 132 404	0.773	32	186	108	165	76	130
63	40	193 132 405	0.798	32	186	108	165	76	130
63	50	193 132 436	1.619	32	234	112	165	100	160
63	63	193 132 437	1.623	32	234	112	165	100	160
75	20	193 132 442	0.879	32	191	113	165	76	130
75	25	193 132 443	0.900	32	191	113	165	76	130
75	32	193 132 444	0.917	32	191	113	165	76	130
75	40	193 132 445	0.958	32	240	118	165	76	160
75	50	193 132 446	1.748	32	240	118	165	100	160
75	63	193 132 447	1.753	32	240	118	165	100	160
90	20	193 132 452	0.856	32	199	121	165	76	130
90	25	193 132 453	0.858	32	199	121	165	76	130
90	32	193 132 454	0.857	32	199	121	165	76	130
90	40	193 132 455	0.780	32	199	126	165	76	130
90	50	193 132 456	1.711	32	248	126	165	100	160
90	63	193 132 457	1.707	32	248	126	165	100	160
110	20	193 132 462	0.907	32	209	131	165	76	130
110	25	193 132 463	0.905	32	209	131	165	76	130
110	32	193 132 464	0.875	32	209	131	165	76	130
110	40	193 132 465	0.961	32	209	136	165	76	130
110	50	193 132 466	1.133	35	258	136	165	100	160
110	63	193 132 467	1.330	35	258	136	165	100	160
125	20	193 132 472	0.938	32	216	138	165	76	130
125	25	193 132 473	0.943	32	216	138	165	76	130
125	32	193 132 474	0.955	32	216	138	165	76	130
125	40	193 132 475	0.964	32	216	143	165	76	130
125	50	193 132 476	1.374	35	256	143	165	100	160
125	63	193 132 477	1.161	35	256	143	165	100	160
140	20	193 132 482	0.941	32	234	146	165	76	130
140	25	193 132 483	0.944	32	234	146	165	76	130
140	32	193 132 484	0.972	32	234	146	165	76	130
140	40	193 132 485	1.020	32	234	146	165	76	130
140	50	193 132 486	1.835	35	283	151	165	100	160
140	63	193 132 487	1.833	35	283	151	165	100	160
160	20	193 132 492	0.910	32	234	156	165	76	130
160	25	193 132 493	0.933	32	234	156	165	76	130
160	32	193 132 494	0.954	32	234	156	165	76	130
160	40	193 132 495	0.965	32	234	161	165	76	130
160	50	193 132 496	1.375	35	283	161	165	100	160
160	63	193 132 497	1.378	35	283	161	165	100	160
180	20	193 132 502	1.020	32	244	166	165	71	130
180	25	193 132 503	1.057	32	244	166	165	71	130
180	32	193 132 504	1.045	32	244	166	165	76	130
180	40	193 132 505	1.122	32	244	171	165	76	130
180	50	193 132 506	1.938	35	293	171	165	100	160
180	63	193 132 507	1.918	35	293	171	165	100	160

table continued on the next page

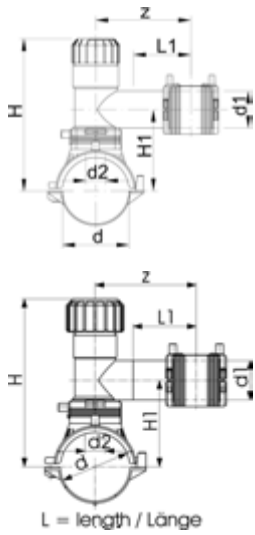

d	d1	Code	Weight	d2	H	H1	L	L1	z	
(mm)	(mm)		(kg)	(mm)	(mm)	(mm)	(mm)	(mm)	(mm)	
200	20	193 132 512	1.065	32	254	176	165	76	130	
200	25	193 132 513	1.065	32	254	176	165	71	130	
200	32	193 132 514	1.095	32	254	176	165	76	130	
200	40	193 132 515	1.131	32	254	181	165	76	130	
200	50	193 132 516	1.957	35	303	181	165	100	160	
200	63	193 132 517	1.900	35	303	181	165	100	160	
225	20	193 132 522	1.460	32	266	188	165	71	130	
225	25	193 132 523	0.991	32	266	188	165	71	130	
225	32	193 132 524	1.095	32	266	188	165	76	130	
225	40	193 132 525	1.134	32	266	193	165	76	130	
225	50	193 132 526	1.921	35	315	193	165	100	160	
225	63	193 132 527	1.951	35	315	193	165	100	160	
250	20	193 132 532	1.079	32	279	201	165	76	130	
250	25	193 132 533	1.095	32	279	201	165	76	130	
250	32	193 132 534	1.092	32	279	201	165	76	130	
250	40	193 132 535	1.113	32	279	206	165	76	160	
250	50	193 132 536	1.971	35	328	206	165	100	160	
250	63	193 132 537	1.923	35	328	206	165	100	160	
*	280	32	193 132 544	1.455	35	328	206	165	100	160
*	280	40	193 132 545	1.500	35	328	206	165	100	160
*	280	50	193 132 546	1.500	35	328	206	165	100	160
*	280	63	193 132 547	1.510	35	328	206	165	100	160
*	315 - 355	32	193 132 554	1.648	35	328	206	165	100	160
*	315 - 355	40	193 132 555	1.015	35	328	206	165	100	160
*	315 - 355	50	193 132 556	1.440	35	328	206	165	100	160
*	315 - 355	63	193 132 557	1.602	35	328	206	165	100	160

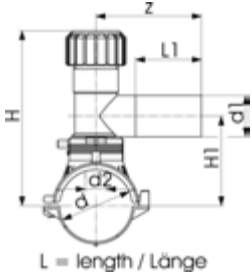

Tapping saddle With 360° rotatable outlet

- PE 100 SDR 11 (ISO S5)
- 10 bar Gas / 16 bar Water
- With integrated cutter to tap live mains under pressure
- Complete with lower part
- 4 mm pin connectors
- Limited path fusion indicators
- Long fusion outlet
- O-ring-sealed screw cap
- d315-400mm: restricted application for pipes d355 and d400mm. Not suitable for pipes if wall thickness is larger than SDR17 pipes.
- *moulded-on lower clamp
- **Delivery without lower part for assembling as Top Load with tool no. 799.350.475; angle adaptor (799.350.340) for fusion cable required

	d	d1	Code	Weight	d2	H	H1	L	L1	z
	(mm)	(mm)		(kg)	(mm)	(mm)	(mm)	(mm)	(mm)	(mm)
	63	20	193 131 402	0.697	32	186	108	165	71	130
	63	25	193 131 403	0.637	32	186	108	165	71	130
	63	32	193 131 404	0.701	32	186	108	165	76	130
	63	40	193 131 405	0.718	32	186	108	165	81	137
	63	63	193 131 437	1.426	32	134	112	165	100	160
	75	20	193 131 442	0.831	32	191	113	165	71	130
	75	25	193 131 443	0.830	32	191	113	165	71	130
	75	32	193 131 444	0.812	32	191	113	165	76	130
	75	40	193 131 445	0.849	32	191	113	165	81	137
	75	63	193 131 447	1.549	32	240	118	165	100	160
	90	20	193 131 452	0.794	32	199	121	165	71	130
	90	25	193 131 453	0.790	32	199	121	165	71	130
	90	32	193 131 454	0.770	32	199	121	165	76	130
	90	40	193 131 455	0.811	32	199	121	165	81	137
	90	63	193 131 457	1.494	32	248	126	165	100	160
*	110	20	193 131 462	0.826	32	209	131	182	71	130
*	110	25	193 131 463	0.808	32	209	131	182	71	130
*	110	32	193 131 464	0.831	32	209	131	182	76	130
*	110	40	193 131 465	0.805	32	209	131	182	81	137
*	110	63	193 131 467	1.097	35	258	136	182	100	160
	125	20	193 131 472	0.880	32	216	138	165	71	130
	125	25	193 131 473	0.878	32	216	138	165	71	130
	125	32	193 131 474	0.878	32	216	138	165	76	130
	125	40	193 131 475	0.874	32	216	138	165	81	137
	125	63	193 131 477	1.184	35	265	143	165	100	160
	140	20	193 131 482	0.887	32	233	146	165	71	130
	140	25	193 131 483	0.874	32	233	146	165	71	130
	140	32	193 131 484	0.894	32	233	146	165	76	130
	140	40	193 131 485	0.920	32	233	146	165	81	137
	140	63	193 131 487	1.180	35	273	151	165	100	160
*	160	20	193 131 492	0.916	32	243	156	182	71	130
*	160	25	193 131 493	0.912	32	243	156	182	71	130
*	160	32	193 131 494	0.915	32	243	156	182	76	130
*	160	40	193 131 495	0.936	32	243	156	182	81	137
*	160	63	193 131 497	1.221	35	283	161	182	100	160
	180	20	193 131 502	0.994	32	244	166	165	71	130
	180	25	193 131 503	1.001	32	244	166	165	71	130
	180	32	193 131 504	0.957	32	244	166	165	76	130
	180	40	193 131 505	1.007	32	244	166	165	81	137
	180	63	193 131 507	1.587	35	293	171	165	100	160
	200	20	193 131 512	1.015	32	254	176	165	71	130
	200	40	193 131 515	1.024	32	254	176	165	81	137
	200	32	193 131 514	0.985	32	254	176	165	76	130
	200	25	193 131 513	1.015	32	254	176	165	71	130
	200	63	193 131 517	1.745	35	303	181	165	100	160
	225	20	193 131 522	1.016	32	266	188	165	71	130
	225	25	193 131 523	1.025	32	266	188	165	71	130
	225	32	193 131 524	1.019	32	266	188	165	76	130

table continued on the next page

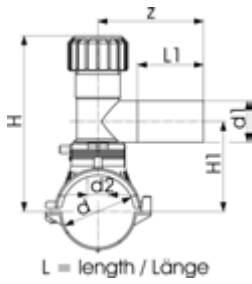

d	d1	Code	Weight	d2	H	H1	L	L1	z
(mm)	(mm)		(kg)	(mm)	(mm)	(mm)	(mm)	(mm)	(mm)
225	40	193 131 525	1.029	32	266	188	165	81	137
225	63	193 131 527	1.738	35	315	193	165	100	160
250	20	193 131 532	1.025	32	279	201	165	76	130
250	25	193 131 533	1.026	32	279	201	165	76	130
250	32	193 131 534	0.996	32	279	201	165	76	130
250	40	193 131 535	1.008	32	279	201	165	81	137
250	63	193 131 537	1.733	35	328	206	165	100	160
**	280	193 131 547	1.478	35	328	206	165	100	160
**	315-355	193 131 557	1.481	35	328	206	165	100	160
**	400	193 131 577	1.473	35	328	206	165	100	160



Tapping saddle With 360° rotatable outlet

- PE 100 SDR 11 (ISO S5)
- 10 bar Gas / 16 bar Water
- With integrated cutter to tap live mains under pressure
- **Suitable to tap SDR11 pipes**
- 4 mm pin connectors
- Limited path fusion indicators
- Long fusion outlet
- O-ring-sealed screw cap
- Delivery without lower part for assembling as Top Load with tool no. 799.350.477; angle adaptor (799.350.340) for fusion cable required

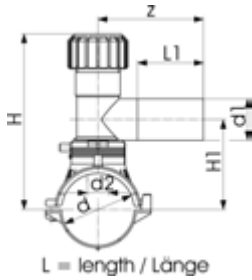

d	d1	Code	Weight	d2	H	H1	L	L1	z
(mm)	(mm)		(kg)	(mm)	(mm)	(mm)	(mm)	(mm)	(mm)
315-355	63	193 131 867	1.473	33	328	206	165	100	160
400	63	193 131 877	1.473	33	328	206	165	100	160



Tapping saddle with gas-stop type 1-5 bar Monobloc version

- PE 100 SDR 11 (ISO S5)
- 5 bar Gas (for pressure 1 bar -5 bar)
- With integrated cutter to tap live mains under pressure
- Complete with lower part
- Gas-Stop System Pipelife (GS 20/1 or GS 32/1)
- **Without overflow orifice**
- Set comes with Gas-Stop pre-assembled
- Installation instructions of Gas-Stop manufacturer are to be observed
- 4 mm pin connectors
- Limited path fusion indicators
- Long fusion outlet
- O-ring-sealed screw cap

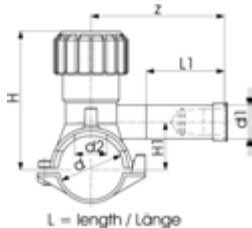

d	d1	Code	Weight	d2	H	H1	L	L1	z	Vn max
(mm)	(mm)		(kg)	(mm)	(mm)	(mm)	(mm)	(mm)	(mm)	(m ³ /h)
40	20	193 281 113	0.214	16	99	33	103	70	102	25
40	32	193 281 152	0.237	16	99	33	103	70	120	100
63	20	193 281 434	0.365	25	134	44	126	70	115	25
63	32	193 281 153	0.840	25	134	44	126	70	130	100

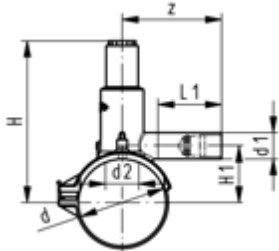

L = length / Länge

Tapping saddle with gas-stop type 1-5 bar Monobloc version

- PE 100 SDR 11 (ISO S5)
- 5 bar Gas (for pressure 1 bar -5 bar)
- With integrated cutter to tap live mains under pressure
- Complete with moulded-on lower part
- Gas-Stop System Pipelife (GS 20/1 or GS 32/1)
- **Without overflow orifice**
- Set comes with Gas-Stop pre-assembled
- Installation instructions of Gas-Stop manufacturer are to be observed
- 4 mm pin connectors
- Limited path fusion indicators
- Long fusion outlet
- O-ring-sealed screw cap

d	d1	Code	Weight	d2	H	H1	L	L1	z	Vn max
(mm)	(mm)		(kg)	(mm)	(mm)	(mm)	(mm)	(mm)	(mm)	(m ³ /h)
63	20	193 130 432	0.368	25	146	44	144	76	110	25
63	32	193 130 434	0.412	25	146	44	144	76	110	100
90	20	193 130 452	0.524	32	198	61	162	76	115	25
90	32	193 130 454	0.520	32	198	61	162	76	115	100
110	20	193 130 462	0.552	32	208	71	162	76	115	25
110	32	193 130 464	0.620	32	208	71	162	76	125	100
125	20	193 130 472	0.664	32	216	79	162	76	120	25
125	32	193 130 474	0.628	32	216	79	162	76	120	100
160	20	193 130 492	0.672	32	233	96	162	76	120	25
160	32	193 130 494	0.786	32	233	96	162	76	130	100

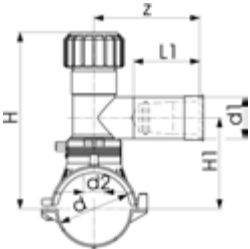

L = length / Länge

Tapping saddle with gas-stop type 1-5 bar With 360° rotatable outlet

- PE 100 SDR 11 (ISO S5)
- 5 bar Gas (for pressure 1 bar -5 bar)
- With integrated cutter to tap live mains under pressure
- Gas-Stop System Pipelife (GS 20/1, GS 32/1, GS 63/1)
- **Without overflow orifice**
- Set comes with Gas-Stop pre-assembled
- Installation instructions of Gas-Stop manufacturer are to be observed
- Complete with lower part
- 4 mm pin connectors
- Limited path fusion indicators
- Long fusion outlet
- O-ring-sealed screw cap

d	d1	Code	Weight	d2	H	H1	L	L1	z	Vn max
(mm)	(mm)		(kg)	(mm)	(mm)	(mm)	(mm)	(mm)	(mm)	(m ³ /h)
63	63	193 281 159	1.548	32	134	112	165	100	160	280
90	20	193 281 435	0.728	25	199	121	165	71	130	25
90	32	193 281 154	0.728	25	199	121	165	76	130	100
90	63	193 281 160	1.642	32	248	126	165	100	160	280
110	20	193 281 437	0.875	25	209	131	165	71	130	25
110	32	193 281 155	0.873	25	209	131	165	76	130	100
110	63	193 281 161	1.691	35	258	136	165	100	160	280
125	20	193 281 438	0.895	25	216	138	165	71	130	25
125	32	193 281 156	0.869	25	216	138	165	76	130	100
125	63	193 281 162	1.724	35	265	143	165	100	160	280
160	20	193 281 439	0.909	25	243	156	165	71	130	25
160	32	193 281 157	0.909	25	243	156	165	76	130	100
160	63	193 281 163	1.737	35	283	161	165	100	160	280
225	20	193 281 122	1.011	25	266	188	165	71	130	25
225	32	193 281 158	1.011	25	266	188	165	76	130	100
225	63	193 281 164	1.864	35	315	193	165	100	160	280

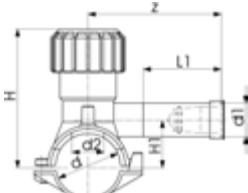

Tapping saddle with gas-stop type AD UE Monobloc version

- PE 100 SDR 11 (ISO S5)
- 1 bar Gas (for pressures from **25 mbar to 1 bar**)
- With integrated cutter to tap live mains under pressure
- Gas-Stop System Pipeline Type AD (GS 32/25 UE)
- **With overflow orifice**
- Set comes with Gas-Stop pre-assembled
- Installation instructions of Gas-Stop manufacturer are to be observed
- Complete with lower part
- 4 mm pin connectors
- Limited path fusion indicators
- Long fusion outlet
- O-ring-sealed screw cap

d (mm)	d1 (mm)	Code	Weight (kg)	d2 (mm)	H (mm)	H1 (mm)	L (mm)	L1 (mm)	z (mm)	Vn max (m ³ /h)
40	32	193 130 614	0.290	16	99	33	103	76	120	10
50	32	193 130 624	0.283	16	104	38	103	76	120	10
63	32	193 130 634	0.446	25	134	44	126	76	130	10

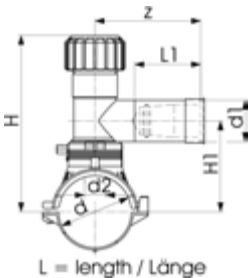

Tapping saddle with gas-stop type AD UE With 360° rotatable outlet

- PE 100 SDR 11 (ISO S5)
- 1 bar Gas (for pressures from **25 mbar to 1 bar**)
- With integrated cutter to tap live mains under pressure
- Gas-Stop System Pipeline Type AD (GS 32/25 UE or GS 63/25 UE)
- **With overflow orifice**
- Set comes with Gas-Stop pre-assembled
- Installation instructions of Gas-Stop manufacturer are to be observed
- Complete with lower part
- 4 mm pin connectors
- Limited path fusion indicators
- Long fusion outlet
- O-ring-sealed screw cap

d (mm)	d1 (mm)	Code	Weight (kg)	d2 (mm)	H (mm)	H1 (mm)	L (mm)	L1 (mm)	z (mm)	Vn max (m ³ /h)
63	32	193 130 604	0.728	32	186	108	165	76	130	10
63	63	193 130 637	1.556	32	134	112	165	100	160	40
75	32	193 130 644	0.854	32	191	113	165	76	130	10
75	63	193 130 647	1.680	32	240	118	165	100	160	40
90	32	193 130 654	0.814	32	199	121	165	76	130	10
90	63	193 130 657	1.642	32	248	126	165	100	160	40
110	32	193 130 664	0.884	32	209	131	165	76	130	10
110	63	193 130 667	1.691	35	258	136	165	100	160	40
125	32	193 130 674	0.902	32	216	138	165	76	130	10
125	63	193 130 677	1.724	35	265	143	165	100	160	40
140	32	193 130 684	0.913	32	233	146	165	76	130	10
140	63	193 130 687	1.740	35	273	151	165	100	160	40
160	32	193 130 694	0.909	32	243	156	165	76	130	10
160	63	193 130 697	1.737	35	283	161	165	100	160	40
180	32	193 130 704	1.015	32	244	166	165	76	130	10
180	63	193 130 707	1.843	35	293	171	165	100	160	40
200	32	193 130 714	1.034	32	254	176	165	76	130	10
200	63	193 130 717	1.862	35	303	181	165	100	160	40
225	32	193 130 724	1.027	32	266	188	165	76	130	10
225	63	193 130 727	1.864	35	315	193	165	100	160	40
250	32	193 130 734	1.048	32	279	201	165	76	130	10
250	63	193 130 737	1.876	35	328	206	165	100	160	40

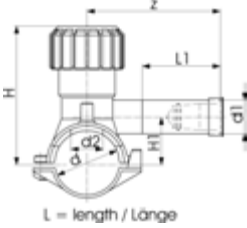

Tapping saddle with gas-stop type B UE Monobloc version

- PE 100 SDR 11 (ISO S5)
- 5 bar Gas (for pressures from **200 mbar to 5 bar**)
- With integrated cutter to tap live mains under pressure
- Gas-Stop System Pipelife Type S (GS 32/200 UE)
- **With overflow orifice**
- Set comes with Gas-Stop pre-assembled
- Installation instructions of Gas-Stop manufacturer are to be observed
- Complete with lower part
- 4 mm pin connectors
- Limited path fusion indicators
- Long fusion outlet
- O-ring-sealed screw cap

d (mm)	d1 (mm)	Code	Weight (kg)	D2 (mm)	d2 (mm)	H (mm)	H1 (mm)	L (mm)	L1 (mm)	z (mm)	Vn max (m ³ /h)
40	32	193 130 814	0.290	16	16	99	33	103	76	120	45
50	32	193 130 824	0.283	16	16	104	38	103	76	120	45
63	32	193 130 834	0.446	25	25	134	44	126	76	130	45

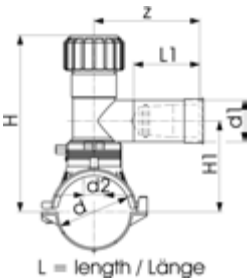

Tapping saddle with gas-stop type S UE With 360° rotatable outlet

- PE 100 SDR 11 (ISO S5)
- 5 bar Gas (for pressures from **200 mbar to 5 bar**)
- With integrated cutter to tap live mains under pressure
- Gas-Stop System Pipelife Type S (GS 32/200 UE or GS 63/200 UE)
- **With overflow orifice**
- Set comes with Gas-Stop pre-assembled
- Installation instructions of Gas-Stop manufacturer are to be observed
- Complete with lower part
- 4 mm pin connectors
- Limited path fusion indicators
- Long fusion outlet
- O-ring-sealed screw cap

d (mm)	d1 (mm)	Code	Weight (kg)	d2 (mm)	H (mm)	H1 (mm)	L (mm)	L1 (mm)	z (mm)	Vn max (m ³ /h)
63	32	193 130 804	0.715	32	186	108	165	76	130	45
63	63	193 130 837	1.540	32	134	112	165	100	160	180
75	32	193 130 844	0.854	32	191	113	165	76	130	45
75	63	193 130 847	1.680	32	240	118	165	100	160	180
90	32	193 130 854	0.813	32	199	121	165	76	130	45
90	63	193 130 857	1.642	32	248	126	165	100	160	180
110	32	193 130 864	0.877	32	209	131	165	76	130	45
110	63	193 130 867	1.691	35	258	136	165	100	160	180
125	32	193 130 874	0.897	32	216	138	165	76	130	45
125	63	193 130 877	1.709	35	265	143	165	100	160	180
140	32	193 130 884	0.913	32	233	146	165	76	130	45
140	63	193 130 887	1.740	35	273	151	165	100	160	180
160	32	193 130 894	0.909	32	243	156	165	76	130	45
160	63	193 130 897	1.737	35	283	161	165	100	160	180
180	32	193 130 904	1.222	32	244	166	165	76	130	45
180	63	193 130 907	1.843	35	293	171	165	100	160	180
200	32	193 130 914	1.034	32	254	176	165	76	130	45
200	63	193 130 917	1.862	35	303	181	165	100	160	180
225	32	193 130 924	1.027	32	266	188	165	76	130	45
225	63	193 130 927	1.828	35	315	193	165	100	160	180
250	32	193 130 934	1.048	32	279	201	165	76	130	45
250	63	193 130 937	1.876	35	328	206	165	100	160	180

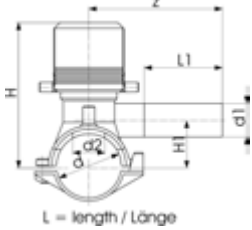

L = length / Länge

Tapping saddle with electrofusion cap Monobloc version

- PE 100 SDR 11 (ISO S5)
- 10 bar Gas / 16 bar Water
- With integrated cutter to tap live mains under pressure
- Complete with lower part
- 4 mm pin connectors
- Limited path fusion indicators
- Long fusion outlet
- Electrofusion Cap

d (mm)	d1 (mm)	Code	Weight (kg)	d2 (mm)	H (mm)	H1 (mm)	L (mm)	L1 (mm)	z (mm)
63	20	193 131 632	0.479	25	134	44	126	71	130
63	25	193 131 633	0.483	25	134	44	126	71	130
63	32	193 131 634	0.483	25	134	44	126	76	130

Pressure tapping valve With 360° rotatable outlet

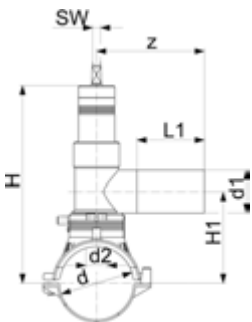

L = length / Länge

- PE 100 SDR 11 (ISO S5)
- 10 bar Gas / 16 bar Water
- With integrated drill bit to tap live mains under pressure
- Complete with lower part and premounted PE100 coated valve piece
- The valve is closed clockwise
- Number of turns to fully open or close valve is 13 for outlet d32
- Number of turns to fully open or close valve is 28 for outlet d63
- Spindle size (SW) 14
- 4 mm pin connectors
- Limited path fusion indicators
- Long fusion outlet
- *moulded-on lower clamp

d (mm)	d1 (mm)	Code	Weight (kg)	d2 (mm)	H (mm)	H1 (mm)	L (mm)	L1 (mm)	z (mm)	
63	32	193 155 234	1.811	21	202	97	165	70	127	
63	63	193 155 237	2.680	31	272	112	165	100	160	
75	32	193 155 244	1.943	21	208	103	165	70	127	
75	63	193 155 247	2.749	31	278	118	165	100	160	
90	32	193 155 254	1.894	21	216	111	165	70	127	
90	63	193 155 257	2.781	31	286	126	165	100	160	
*	110	32	193 155 264	1.896	21	226	121	165	70	127
*	110	63	193 155 267	2.739	31	296	136	165	100	160
	125	32	193 155 274	1.986	21	233	128	165	70	127
	125	63	193 155 277	2.867	31	303	143	165	100	160
	140	32	193 155 284	2.009	21	241	136	165	70	127
	140	63	193 155 287	2.908	31	311	151	165	100	160
*	160	32	193 155 294	2.029	21	251	146	165	70	127
*	160	63	193 155 297	2.913	31	321	161	165	100	160
	180	32	193 155 304	2.111	21	261	156	165	70	127
	180	63	193 155 307	2.923	31	331	171	165	100	160
	200	32	193 155 314	2.127	21	271	166	165	70	127
	200	63	193 155 317	3.007	31	341	181	165	100	160
	225	32	193 155 324	2.091	21	281	178	165	70	127
	225	63	193 155 327	2.932	31	353	193	165	100	160
	250	63	193 155 337	2.978	31	366	206	165	100	160

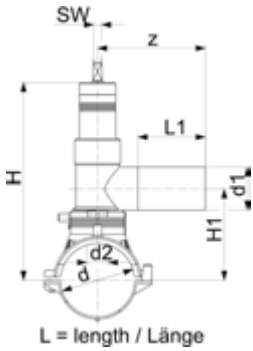

Pressure tapping valve With 360° rotatable outlet

- PE 100 SDR 11 (ISO S5)
- 10 bar Gas / 16 bar Water
- With integrated drill bit to tap live mains under pressure
- **Suitable for pipes with wall thickness between 7 and 21 mm only.**
- Complete with lower part and premounted PE100 coated valve piece
- The valve is closed clockwise
- Number of turns to fully open or close valve is 13 for outlet d32
- Number of turns to fully open or close valve is 28 for outlet d63
- Spindle size (SW) 14
- 4 mm pin connectors
- Limited path fusion indicators
- Long fusion outlet
- *Delivery without lower part for assembling as Top Load with tool no. 799.350.477; angle adaptor (799.350.340) for fusion cable required

	d	d1	Code	Weight	L1	H1	z	L	H	d2
	(mm)	(mm)		(kg)	(mm)	(mm)	(mm)	(mm)	(mm)	(mm)
	250	32	193 155 334	2.096	70	191	127	165	293	21
*	280	32	193 155 344	1.835	70	191	127	165	293	21
*	280	63	193 155 347	3.000	100	206	160	165	366	31
*	315 - 355	32	193 155 354	3.000	70	191	127	165	293	21
*	315 - 355	63	193 155 357	2.696	100	206	160	165	366	31
*	400	32	193 155 374	3.000	70	191	127	165	293	21
*	400	63	193 155 377	3.000	100	206	160	165	366	31

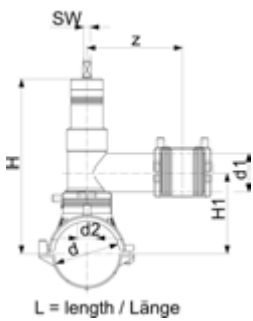

Pressure tapping valve (kit) With 360° rotatable outlet

- PE 100 SDR 11 (ISO S5)
- 10 bar Gas / 16 bar Water
- With integrated drill bit to tap live mains under pressure
- Complete with lower part and premounted PE100 coated valve piece
- The valve is closed clockwise
- Number of turns to fully open or close valve is 13 for outlet d32
- Number of turns to fully open or close valve is 28 for outlet d 40, d 50, d 63
- Spindle size (SW) 14
- 4 mm pin connectors
- Limited path fusion indicators
- Long fusion outlet
- Supplied as Kit with enclosed service line fitting (ELGEF Plus Coupler or Reducer)

d	d1	Code	Weight	d2	H	H1	L	z
(mm)	(mm)		(kg)	(mm)	(mm)	(mm)	(mm)	(mm)
63	32	193 155 034	1.864	21	202	97	165	127
63	40	193 155 035	2.862	31	272	112	165	160
63	50	193 155 036	2.879	31	272	112	165	160
63	63	193 155 037	2.887	31	272	112	165	160
75	32	193 155 044	3.243	21	208	103	165	127
75	40	193 155 045	3.249	31	278	118	165	160
75	50	193 155 046	3.261	31	278	118	165	160
75	63	193 155 047	3.259	31	278	118	165	160
90	32	193 155 054	1.962	21	216	111	165	127
90	40	193 155 055	2.957	31	286	126	165	160
90	50	193 155 056	2.970	31	286	126	165	160
90	63	193 155 057	2.924	31	286	126	165	160
110	32	193 155 064	2.030	21	226	121	165	127
110	40	193 155 065	2.984	31	296	136	165	160
110	50	193 155 066	2.696	31	296	136	165	160
110	63	193 155 067	3.010	31	296	136	165	160
125	32	193 155 074	2.039	21	233	128	165	127
125	40	193 155 075	3.007	31	303	143	165	160
125	50	193 155 076	3.023	31	303	143	165	160
125	63	193 155 077	3.058	31	303	143	165	160
140	32	193 155 084	3.301	21	241	136	165	127

table continued on the next page

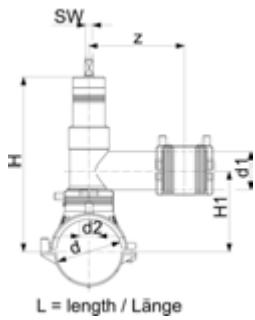

d	d1	Code	Weight	d2	H	H1	L	z
(mm)	(mm)		(kg)	(mm)	(mm)	(mm)	(mm)	(mm)
140	40	193 155 085	3.040	31	311	151	165	160
140	50	193 155 086	3.315	31	311	151	165	160
140	63	193 155 087	3.313	31	311	151	165	160
160	32	193 155 094	2.057	21	251	146	165	127
160	40	193 155 095	2.980	31	321	161	165	160
160	50	193 155 096	3.022	31	321	161	165	160
160	63	193 155 097	3.025	31	321	161	165	160
180	32	193 155 104	3.410	21	261	156	165	127
180	40	193 155 105	3.126	31	331	171	165	160
180	50	193 155 106	3.181	31	331	171	165	160
180	63	193 155 107	3.164	31	331	171	165	160
200	32	193 155 114	3.431	21	271	166	165	127
200	40	193 155 115	3.435	31	341	181	165	160
200	50	193 155 116	3.453	31	341	181	165	160
200	63	193 155 117	3.215	31	341	181	165	160
225	32	193 155 124	2.195	21	281	178	165	127
225	40	193 155 125	3.178	31	353	193	165	160
225	50	193 155 126	3.120	31	353	193	165	160
225	63	193 155 127	3.196	31	353	193	165	160
250	40	193 155 135	3.449	30	366	206	165	160
250	50	193 155 136	3.124	30	366	206	165	160
250	63	193 155 137	3.221	30	366	206	165	160

Pressure tapping valve (kit) With 360° rotatable outlet



- PE 100 SDR 11 (ISO S5)
- 10 bar Gas / 16 bar Water
- With integrated drill bit to tap live mains under pressure
- **Suitable for pipes with wall thickness between 7 and 21 mm only.**
- Complete with lower part and premounted PE100 coated valve piece
- The valve is closed clockwise
- Number of turns to fully open or close valve is 13 for outlet d32
- Number of turns to fully open or close valve is 28 for outlet d 40, d 50, d 63
- Spindle size (SW) 14
- 4 mm pin connectors
- Limited path fusion indicators
- Long fusion outlet
- Supplied as Kit with enclosed service line fitting (ELGEF Plus Coupler or Reducer)
- *Delivery without lower part for assembling as Top Load with tool no. 799.350.477; angle adaptor (799.350.340) for fusion cable required

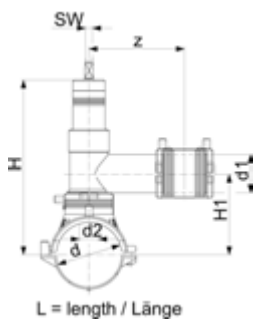

	d	d1	Code	Weight	d2	H	H1	L	z
	(mm)	(mm)		(kg)	(mm)	(mm)	(mm)	(mm)	(mm)
	250	32	193 155 134	3.443	21	293	191	165	127
*	280	32	193 155 144	3.118	21	293	191	165	127
*	280	40	193 155 145	2.913	30	366	206	165	160
*	280	50	193 155 146	3.136	30	366	206	165	160
*	280	63	193 155 147	2.719	30	366	206	165	160
*	315 - 355	32	193 155 154	3.118	21	293	191	165	127
*	315 - 355	40	193 155 155	3.124	30	366	206	165	160
*	315 - 355	50	193 155 156	3.136	30	366	206	165	160
*	315 - 355	63	193 155 157	3.134	30	366	206	165	160

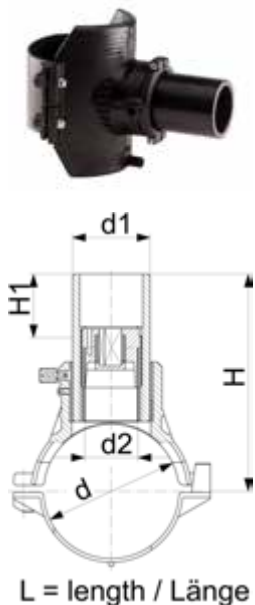

Spigot saddle with cutter

- PE 100 SDR 11 (ISO S5)
- 10 bar Gas / 16 bar Water
- Complete with lower part
- 4 mm pin connectors
- Limited path fusion indicators
- d315 - 400 mm: application is limited on pipes d355 and d400 mm. Not suitable for pipes if larger wall thickness than SDR 17 pipes.
- *Delivery without lower part for assembling as Top Load with tool no. 799.350.477; angle adaptor (799.350.340) for fusion cable required

	d	d1	Code	Weight	d2	H	H1	L	SW	SDR pipe
	(mm)	(mm)		(kg)	(mm)	(mm)	(mm)	(mm)	(mm)	
	63	32	193 131 234	0.469	19	145	50	165	13	9 - 11
	63	63	193 131 237	1.036	32	152	50	165	17	9 - 11
	75	32	193 131 244	0.618	19	151	50	165	13	9 - 11
	75	63	193 131 247	1.166	32	158	50	165	17	9 - 11
	90	32	193 131 254	0.543	19	158	50	165	13	9 - 11
	90	63	193 131 257	1.128	32	165	50	165	17	9 - 11
	110	32	193 131 264	0.607	19	168	50	165	13	9 - 11
	110	63	193 131 267	1.195	32	175	50	165	17	9 - 11
	125	32	193 131 274	0.659	19	176	50	165	13	9 - 11
	125	63	193 131 277	1.224	32	183	50	165	17	9 - 11
	140	32	193 131 284	0.679	19	183	50	165	13	9 - 11
	140	63	193 131 287	1.224	32	190	50	165	17	9 - 11
	160	32	193 131 294	0.652	19	193	50	165	13	9 - 11
	160	63	193 131 297	1.186	32	200	50	165	17	9 - 11
	180	32	193 131 304	0.777	19	203	50	165	13	9 - 26
	180	63	193 131 307	1.316	32	210	50	165	17	9 - 26
	200	32	193 131 314	0.854	19	213	50	165	13	9 - 26
	200	63	193 131 317	1.352	32	220	50	165	17	9 - 26
	225	32	193 131 324	0.856	19	226	50	165	13	11 - 26
	225	63	193 131 327	1.324	32	233	50	165	17	11 - 26
	250	32	193 131 334	0.787	19	238	50	165	13	11 - 26
	250	63	193 131 337	1.348	32	245	50	165	17	11 - 26
*	280	63	193 131 347	0.830	35	245	50	165	17	11 - 26
*	315 - 355	63	193 131 357	1.094	35	245	50	165	17	17 - 33
*	400	63	193 131 377	0.830	35	245	50	165	17	17 - 33

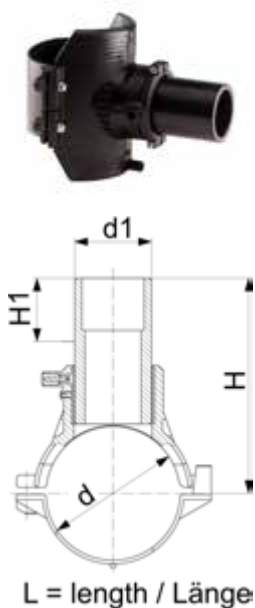

Spigot saddle

- PE 100 SDR 11 (ISO S5)
- 10 bar Gas / 16 bar Water
- Complete with lower part
- 4 mm pin connectors
- Limited path fusion indicators
- d315 - 400 mm: application is limited on pipes d355 and d400 mm. Not suitable for pipes if larger wall thickness than SDR 17 pipes.
- *Delivery without lower part for assembling as Top Load with tool no. 799.350.477; angle adaptor (799.350.340) for fusion cable required

	d	d1	Code	Weight	H	H1	L
	(mm)	(mm)		(kg)	(mm)	(mm)	(mm)
	63	32	193 130 234	0.434	145	50	165
	63	63	193 130 237	0.630	152	50	165
	75	32	193 130 244	0.634	151	50	165
	75	63	193 130 247	0.536	158	50	165
	90	32	193 130 254	0.508	158	50	165
	90	63	193 130 257	0.573	165	50	165
	110	32	193 130 264	0.590	168	50	165
	110	63	193 130 267	0.600	175	50	165
	125	32	193 130 274	0.594	176	50	165
	125	63	193 130 277	0.660	183	50	165
	140	32	193 130 284	0.638	183	50	165
	140	63	193 130 287	0.594	190	50	165

table continued on the next page

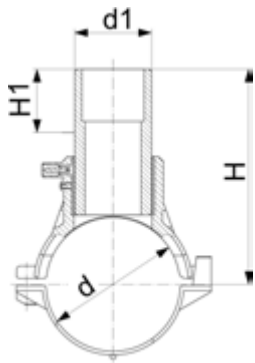

L = length / Länge

d (mm)	d1 (mm)	Code	Weight (kg)	H (mm)	H1 (mm)	L (mm)
160	32	193 130 294	0.600	193	50	165
160	63	193 130 297	0.658	200	50	165
180	32	193 130 304	0.742	203	50	165
180	63	193 130 307	0.771	210	50	165
200	32	193 130 314	0.766	213	50	165
200	63	193 130 317	0.762	220	50	165
225	32	193 130 324	0.730	226	50	165
225	63	193 130 327	0.782	233	50	165
250	32	193 130 334	0.741	238	50	165
250	63	193 130 337	0.792	245	50	165
*	280	193 130 347	0.400	245	50	165
*	315 - 355	193 130 357	0.503	245	50	165
*	400	193 130 377	0.400	245	50	165



Tapping key for saddles

- With adjustable tapping depth.

Type	Code	Weight (kg)	Description
WS - 10	799 198 080	0.114	for Monobloc d 40 mm and d 50 mm
WS - 17	799 198 079	0.556	for Monobloc d 63 mm, d 90 - 160 mm and all Duobloc saddles
WS - 12.7	799 198 091	0.600	for socket with cutter



Pressure test cap for Tapping saddles

- The cap has a Rp 3/8" connection thread and is made from galvanised steel.
- **Overview of Tapping Adapter types and Pressure Test Cap**
- M For Monobloc d 40 and 50 mm (outlets d 20 - 32 mm)
- S 54 For all saddles with rotatable outlet (outlets d 20 - 40 mm) i.e. Tapping Tee d 20 - 40 mm.
- S 67 For all Saddles with rotatable outlet (outlets d 50 and 63 mm) i.e. Tapping Tee d 63 mm.

Type	Code	Weight (kg)	Description
M	799 199 282	0.116	for Monobloc d 40 mm and d 50 mm
S 54	799 199 283	0.260	for Tapping Tee d 20 - 40 mm
S 67	799 199 286	0.430	for Tapping Tee outlet d 63 mm
MB	799 199 287	0.037	for Monobloc d63-160 mm



Tapping Adapter for saddles

- The Adapter is used for gas-free tapping under pressure. Type S 54 for tapping saddles with rotatable outlet d 20 - 40 mm (Tapping Tee d 32 mm). Type S 67 for tapping saddles with rotatable outlet d 50 - 63 mm (Tapping Tee d 63 mm).

Type	Code	Weight (kg)	Description
S 54	799 100 061	0.785	for Tapping Tee d 32 mm
S 67	799 100 062	1.011	for Tapping Tee d 63 mm



Hexagon key for saddles and branch fittings

- For tightening fixation screws.

Type	Code	Weight (kg)	Description
SW8	799 150 378	0.129	For all saddles and branch fittings

Branch Saddle PE100

Branch saddle outlet 90-125 mm

Branch saddle topload outlet 90-500 mm



ELGEF Plus branch saddle

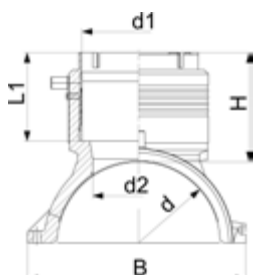

Branch saddle outlet 90 - 125 mm

- PE 100 SDR 11 (ISO S5)
- 10 bar Gas / 16 bar Water
- Branch Saddle complete, incl. lower part and 3 screws
- Additional fixing with snatch hinge
- Electrofusion outlet with integrated pipe fixation
- Protected wire without medium contact
- 4 mm pin connectors
- Limited path fusion indicators
- * Delivered without lower part. Pipe fixation with multiple use assembly toolno. 193.281.027

d (mm)	d1 (mm)	Code	Weight (kg)	H (mm)	L (mm)	L1 (mm)	B (mm)	d2 (mm)	SDR pipe	
110	90	193 135 009	1.124	101	220	82	164	65	9-17.6	
110	110	193 135 010	1.224	107	220	88	164	65	9-17.6	
125	90	193 135 019	1.134	101	220	82	179	65	9-17.6	
125	110	193 135 020	1.290	107	220	88	179	65	9-17.6	
*	140	90	193 135 029	0.982	101	220	81	195	65	9-17.6
*	140	110	193 135 030	1.087	107	220	87	195	65	9-17.6
160	90	193 135 039	1.449	102	240	82	215	65	9-17.6	
160	110	193 135 040	1.582	108	240	88	215	86	9-17.6	
160	125	193 135 041	1.782	129	240	99	215	86	9-17.6	
180	90	193 135 049	1.672	102	260	82	237	65	9-17.6	
180	110	193 135 050	1.765	108	260	88	237	86	9-17.6	
180	125	193 135 051	2.015	129	260	99	237	86	9-17.6	
200	90	193 135 059	1.803	102	260	82	253	65	9-17.6	
200	110	193 135 060	1.963	108	260	88	253	86	9-17.6	
200	125	193 135 061	2.128	129	260	99	253	86	9-17.6	
225	90	193 135 069	2.006	102	260	82	287	65	9-17.6	
225	110	193 135 070	2.400	108	260	88	287	86	9-17.6	
225	125	193 135 071	2.312	129	260	99	287	86	9-17.6	
250	90	193 135 079	2.145	102	260	82	312	65	9-17.6	
250	110	193 135 080	2.258	108	260	88	312	86	9-17.6	
250	125	193 135 081	2.500	129	260	99	312	86	9-17.6	



Cross connection branch saddle

- Enables the connection of two Branch Saddle as a cross
- Complete with screws, flat washers and nuts

d (mm)	Code	Weight (kg)
110 - 160	193 280 880	0.268
180 - 250	193 280 881	0.282



Multiple use assembly tool branch saddle d140mm

- Only to be used with Branch Saddle d140mm
- Delivered as complete Kit including screws and belt

d (mm)	Code	Weight (kg)
140	193 281 027	0.724

**Branch saddle topload
outlet 90 - 125 mm**



- PE 100 SDR 11 (ISO S5)
- 10 bar Gas / 16 bar Water
- Branch Saddle for assembling as Topload with tool 799.350.477; angle adaptors (799.350.340) for fusion cable required
- Electrofusion outlet with integrated pipe fixation
- Protected wire without medium contact
- 4 mm pin connectors
- Limited path fusion indicators

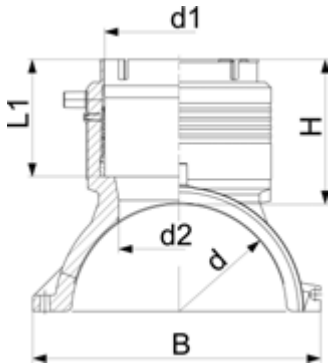

d (mm)	d1 (mm)	Code	Weight (kg)	H (mm)	L (mm)	L1 (mm)	B (mm)	d2 (mm)	SDR pipe
280	90	193 135 289	1.242	102	260	82	243	65	9-26
280	110	193 135 290	1.295	108	260	88	243	86	9-26
280	125	193 135 291	1.530	129	260	99	243	86	9-26
315 - 355	90	193 135 309	1.214	102	260	82	249	65	9-26
315 - 355	110	193 135 310	1.297	108	260	88	249	86	9-26
315 - 355	125	193 135 311	1.530	129	260	99	249	86	9-26
400	90	193 135 329	1.022	102	260	82	256	65	9-26
400	110	193 135 330	1.116	108	260	88	256	86	9-26
400	125	193 135 331	1.369	129	260	99	256	86	9-26
450	90	193 135 339	1.022	102	260	82	256	65	9-26
450	110	193 135 340	1.116	108	260	88	256	86	9-26
450	125	193 135 341	1.369	129	260	99	256	86	9-26
500 - 630	90	193 135 159	1.086	102	260	82	263	65	9-26
500 - 630	110	193 135 160	1.159	108	260	88	263	86	9-26
500 - 630	125	193 135 161	1.388	129	260	99	263	86	9-26

**Branch saddle topload
outlet 160 - 225 mm**



- PE 100 SDR 11 (ISO S5)
- 10 bar Gas / 16 bar Water
- Branch Saddle installation only with installation set Topload TL225 (799.300.807)
- Angle adaptors (799.350.340) for fusion cable required
- 4 mm pin connectors
- Limited path fusion indicators
- Spigot outlet for butt- and electrofusion
- Full pressure applicable - no derating factor
- With integrated pressure test port for test cap (799.199.877)

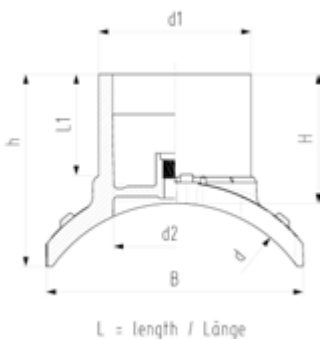

L = length / Länge

d (mm)	d1 (mm)	Code	Weight (kg)	h (mm)	H (mm)	L (mm)	L1 (mm)	B (mm)	d2 (mm)	SDR pipe
315	160	193 135 202	2.662	212	137	322	110	282	131	11-26
315	225	193 135 204	4.724	306	160	366	127	260	184	11-26
355	160	193 135 212	2.662	206	137	322	110	282	131	11-26
355	225	193 135 214	4.710	319	160	366	127	249	184	11-26
400	160	193 135 222	2.678	198	137	322	110	300	131	11-26
400	225	193 135 224	4.700	329	160	366	127	241	184	11-26
450	160	193 135 232	2.678	194	137	322	110	300	131	11-26
450	225	193 135 234	4.700	329	160	366	127	233	184	11-26
500	160	193 135 242	2.708	186	137	322	110	310	131	11-26
500	225	193 135 244	4.650	344	160	366	127	226	184	11-26
560	160	193 135 252	2.708	183	137	322	110	310	131	11-26
560	225	193 135 254	4.650	344	160	366	127	220	184	11-26
630	160	193 135 262	2.500	177	137	322	110	312	131	11-33
630	225	193 135 264	4.850	353	160	366	127	214	184	11-33
710	160	193 135 272	2.500	172	137	322	110	312	131	11-33
710	225	193 135 174	4.760	352	160	366	127	208	184	11-33
800	160	193 135 282	2.500	168	137	366	127	312	131	11-33
800	225	193 135 284	4.610	359	160	366	127	203	184	11-33
900	225	193 135 294	4.610	359	160	366	127	199	184	11-33
1000	225	193 135 304	4.610	359	160	366	127	195	184	11-33



Branch saddle topload outlet 315 mm

- PE 100 SDR 11 (ISO S5)
- 10 bar Gas / 16 bar Water
- Branch saddle installation only with installation set Topload TL315 (799.350.808) or TL500 (799.300.809)
- Angle adaptors (799.350.340) for fusion cable required
- 4 mm pin connectors
- Protected wire without medium contact
- Spigot outlet for butt- and electrofusion
- Full pressure applicable - no derating factor

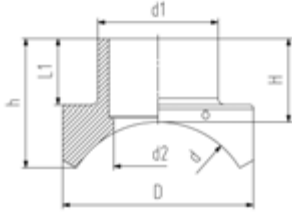

d (mm)	d1 (mm)	Code	Weight (kg)	h (mm)	H (mm)	L (mm)	L1 (mm)	D (mm)	d2 (mm)	SDR pipe
450	315	193 135 436	18.500	216	346	500	157	500	232	11 - 26
500	315	193 135 446	17.000	216	337	500	157	500	232	11 - 26
560	315	193 135 456	16.100	216	327	500	157	500	232	11 - 26
630	315	193 135 466	15.950	216	312	500	157	500	232	11 - 33
710	315	193 135 476	14.800	216	297	500	157	500	232	11 - 33
800	315	193 135 486	14.300	216	287	500	157	500	232	11 - 33
900	315	193 135 496	13.800	216	281	500	157	500	232	11 - 33
1000	315	193 135 506	13.500	216	274	500	157	500	232	11 - 33



Branch saddle topload outlet 315 - 500 mm

- PE 100 SDR 17 (ISO S8)
- 5 bar Gas / 10 bar Water
- Branch saddle installation only with installation set Topload TL500 (799.300.809)
- Angle adaptors (799.350.340) for fusion cable required
- 4 mm pin connectors
- Protected wire without medium contact
- Spigot outlet for butt- and electrofusion
- Full pressure applicable - no derating factor

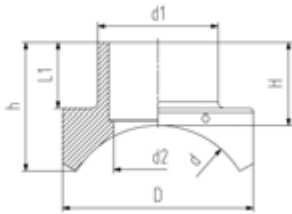

d (mm)	d1 (mm)	Code	Weight (kg)	h (mm)	H (mm)	L (mm)	L1 (mm)	D (mm)	d2 (mm)	SDR pipe
710	315	193 135 676	14.000	174	266	500	157	500	250	11 - 33
800	315	193 135 686	13.500	174	261	500	157	500	250	11 - 33
900	315	193 135 696	13.100	174	251	500	157	500	250	11 - 33
900	500	193 135 698	32.600	237	406	700	219	700	397	11 - 33
1000	315	193 135 706	12.800	174	246	500	157	500	250	11 - 33
1000	500	193 135 708	31.400	237	396	700	219	700	397	11 - 33
1200	315	193 135 716	12.300	174	241	500	157	500	250	11 - 33
1200	500	193 135 718	29.400	237	378	700	219	700	397	11 - 33
1400	315	193 135 726	11.900	174	234	500	157	500	250	11 - 33
1400	500	193 135 728	28.100	237	363	700	219	700	397	11 - 33
1600	315	193 135 736	11.700	174	228	500	157	500	250	11 - 33
1600	500	193 135 738	27.100	237	352	700	219	700	397	11 - 33
2000	315	193 135 746	11.300	174	221	500	157	500	250	11 - 33
2000	500	193 135 748	25.700	237	337	700	219	700	397	11 - 33



Pressure Test Cap

- Enables pressure testing of branch saddles ELGEF Plus after fusion and before tapping the main pipe
- Suitable for branch saddle with spigot outlet (193135402 - 748)
- Recommended maximum test pressure at +20°C according DVS 2210-1 = 18 bar water (SDR11) / 11 bar water (SDR 17)
- Recommended test duration = 60 minutes
- Connecting thread for pressure test is female thread G 3/8"

d (mm)	Code	description	L (mm)	B (mm)	H (mm)
160 - 225	799 199 287	Suitable for branch saddle with spigot outlet d160 and d225mm and Tapping saddles Monobloc main dimension d63-160mm; Material: Aluminum; Scope of delivery: 1 x Pressure test cap, 1 x O-ring 25.07 x 2.62	26	36	39
315	799 199 288	Suitable for branch saddle with spigot outlet d315mm; Scope of delivery: 1 x pressure test cap, 1 x O-Ring, 1 x GEKA-plus hose nipple, 1 x GEKA-plus transition female thread G3/8", 1 x Transport box	310	310	320
500	799 199 289	Suitable for branch saddle with spigot outlet d500mm; Scope of delivery: 1 x pressure test cap, 1 x O-Ring, 1 x GEKA-plus hose nipple, 1 x GEKA-plus transition female thread G3/8", 1 x Transport box	465	465	400

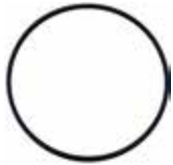

Accessories / single parts for Pressure test cap

- Suitable for Pressure test cap

Code	description	L (mm)	B (mm)	H (mm)
799 199 321	1 x O-Ring for 799199288 d315	222	222	7
799 199 322	1 x O-Ring for 799199289 d500	380	380	7
799 199 323	1 x GEKA-plus transtion female thread G 3/8"	55	55	35
799 199 327	1 x Transport box for 799199288 d315	310	310	320
799 199 328	1 x Transport box for 799199289 d500	465	465	400

Polyethylene Piping Systems PE100

**Spigot Fittings for electrofusion
and butt fusion (long ends)**



Spigot fittings in PE100

Elbows

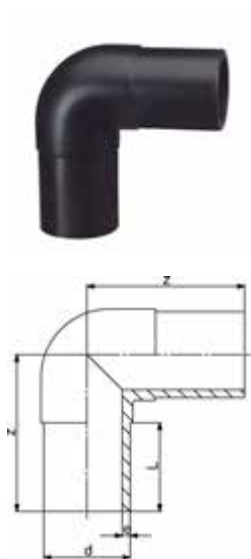

Elbow 90° PE 100 SDR11

- Long spigot version
- 10 bar Gas / 16 bar Water

d (mm)	Code	Weight (kg)	z (mm)	L (mm)	e (mm)	PF
20	753 101 006	0.027	75	52	3.0	2 51 301 001
25	753 101 007	0.040	80	52	3.0	2 51 301 001
32	753 101 008	0.056	85	54	3.0	2 51 301 001
40	753 101 009	0.089	95	57	3.7	2 51 301 001
50	753 101 010	0.156	105	63	4.6	2 51 301 001
63	753 101 011	0.274	115	65	5.8	2 51 301 001
75	753 101 012	0.414	130	72	6.8	2 51 301 001
90	753 101 013	0.704	150	81	8.2	2 51 301 001
110	753 101 014	1.158	165	86	10.0	2 51 301 001
125	753 101 015	1.609	180	92	11.4	2 51 301 001
140	753 101 016	2.222	194	92	12.7	2 51 301 001
160	753 101 017	3.100	210	102	14.6	2 51 301 001
180	753 101 018	4.328	232	107	16.4	2 51 301 001
200	753 101 019	5.739	253	117	18.2	2 51 301 001
225	753 101 020	7.775	270	122	20.5	2 51 301 001
250	753 101 001	10.506	292	130	22.7	2 51 301 002
280	753 100 922	15.059	320	140	25.4	2 51 301 002
315	753 100 923	21.960	370	150	28.6	2 51 301 002

Elbow 90° PE100 SDR17/17,6

- Long spigot version
- 5 bar Gas / 10 bar Water

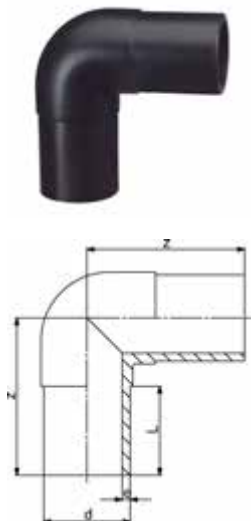

d (mm)	Code	Weight (kg)	z (mm)	L (mm)	e (mm)	PSI
90	753 100 813	0.543	150	81	5.4	130
110	753 100 814	0.876	165	86	6.6	130
125	753 100 815	0.927	180	93	7.4	130
140	753 100 816	1.547	194	92	8.3	130
160	753 100 817	2.385	210	102	9.5	130
180	753 100 818	3.205	232	107	10.7	130
200	753 100 819	4.298	253	115	11.9	130
225	753 100 820	5.864	270	120	13.4	130
250	753 100 821	8.000	292	130	14.8	130
280	753 100 822	11.328	320	140	16.6	
315	753 100 823	15.877	370	150	18.7	

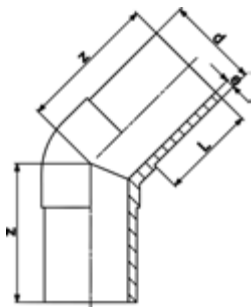

Elbow 45° PE100 SDR11

- Long spigot version
- 10 bar Gas / 16 bar Water

d (mm)	Code	Weight (kg)	z (mm)	L (mm)	e (mm)
20	753 151 006	0.027	70	52	3.0
25	753 151 007	0.037	75	52	3.0
32	753 151 008	0.050	80	54	3.0
40	753 151 009	0.086	85	57	3.7
50	753 151 010	0.133	90	63	4.6
63	753 151 011	0.227	95	65	5.8
75	753 151 012	0.350	105	72	6.8
90	753 151 013	0.565	120	81	8.2
110	753 151 014	0.921	130	86	10.0
125	753 151 015	1.290	140	92	11.4
140	753 151 016	1.796	164	120	12.7
160	753 151 017	2.454	162	102	14.6
180	753 151 018	3.274	170	107	16.4
200	753 151 019	4.362	186	116	18.2
225	753 151 020	5.981	200	123	20.5
250	753 151 021	8.283	220	130	22.7
280	753 150 922	10.285	230	140	25.4
315	753 150 923	14.124	250	150	28.6

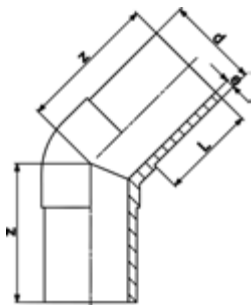

Elbow 45° PE100 SDR17/17,6

- 5 bar Gas / 10 bar Water
- Long spigot version

d (mm)	Code	Weight (kg)	z (mm)	L (mm)	e (mm)	PSI
90	753 150 813	0.411	120	81	5.4	130
110	753 150 814	0.686	130	86	6.6	130
125	753 150 815	0.948	140	92	7.4	
140	753 150 816	1.259	164	120	8.3	
160	753 150 817	1.901	162	102	9.5	130
180	753 150 818	2.386	170	107	10.7	
200	753 150 819	3.153	186	116	11.9	
225	753 150 820	4.441	205	123	13.4	130
250	753 150 821	6.012	217	130	14.8	130
280	753 150 822	7.489	230	140	16.6	
315	753 150 823	10.123	250	150	18.7	

Elbow 30° PE100 SDR11

- Long spigot version
- 10 bar Gas / 16 bar Water
- Welded design



d (mm)	Code	Weight (kg)	z (mm)	L (mm)	e (mm)
32	753 120 908	0.530	70	54	3.0
40	753 120 909	0.530	80	57	3.7
50	753 120 910	0.121	80	63	4.6
63	753 120 911	0.207	80	65	5.8
75	753 120 912	0.311	90	72	6.8
90	753 120 913	0.510	100	81	8.2
110	753 120 914	0.840	105	86	10.0
125	753 120 915	1.174	115	92	11.4
140	753 120 916	1.760	135	92	12.7
160	753 120 917	2.155	130	102	14.6
180	753 120 918	2.911	140	107	16.4
200	753 120 919	3.892	150	116	18.2
225	753 120 920	5.332	165	123	20.5
250	753 120 921	7.307	190	130	22.7
280	753 120 922	10.600	200	139	25.4
315	753 120 923	12.775	200	150	28.6

Elbow 30° PE100 SDR17/17,6

- Long spigot version
- 5 bar Gas / 10 bar Water
- Welded design



d (mm)	Code	Weight (kg)	z (mm)	L (mm)	e (mm)
90	753 120 813	0.363	110	81	5.4
110	753 120 814	0.607	115	86	6.6
125	753 120 815	0.819	125	92	7.4
140	753 120 816	1.112	150	92	8.3
160	753 120 817	1.526	140	102	9.5
180	753 120 818	2.040	150	107	10.7
200	753 120 819	2.780	160	116	11.9
225	753 120 820	3.798	180	123	13.4
250	753 120 821	5.039	200	130	14.8
280	753 120 822	8.100	200	139	16.6
315	753 120 823	8.655	220	150	18.7

Elbow 15° type L PE100 SDR11

- Long spigot version
- 10 bar Gas / 16 bar Water
- Welded design

d (mm)	Code	Weight (kg)	z (mm)	L (mm)	e (mm)
32	753 141 008	0.051	70	54	3
40	753 141 009	0.082	80	57	4
50	753 141 010	0.118	80	63	5
63	753 141 011	0.200	80	65	6
75	753 141 012	0.290	90	72	7
90	753 141 013	0.479	100	81	8
110	753 141 014	0.785	105	86	10
125	753 141 015	1.063	115	92	11
140	753 141 016	1.600	135	92	13
160	753 141 017	2.170	130	102	15
180	753 141 018	2.653	140	107	16
200	753 141 019	3.438	150	116	18
225	753 141 020	4.765	165	123	21
250	753 141 021	8.300	190	130	23
280	753 141 022	8.322	200	139	25
315	753 141 023	11.292	200	150	29



Elbow 15° PE100 SDR17/17,6

- Long spigot version
- 5 bar Gas / 10 bar Water
- Welded design

d (mm)	Code	Weight (kg)	z (mm)	L (mm)	e (mm)
90	753 140 813	0.337	100	81	5
110	753 140 814	0.551	105	86	7
125	753 140 815	0.728	115	92	7
140	753 140 816	0.370	135	92	8
160	753 140 817	1.364	130	102	10
180	753 140 818	2.040	140	107	11
200	753 140 819	2.371	150	116	12
225	753 140 820	3.335	165	123	13
250	753 140 821	5.830	190	130	15
280	753 140 822	8.100	195	139	17
315	753 140 823	7.528	200	150	19



Bends

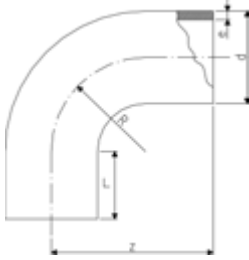

Bend 90° PE100 SDR11

- Long spigot version
- bends made out of seamless pipe shall not be shortened
- 10 bar Gas / 16 bar Water
- * made out of seamless pipe. This shall not be shortened.

d (mm)	Code	Weight (kg)	z (mm)	L (mm)	R (mm)	e (mm)	
32	753 001 008	0.042	78	46	32	2.9	
40	753 001 009	0.090	91	49	40	3.7	
50	753 001 010	0.160	107	55	50	4.6	
63	753 001 011	0.280	130	63	63	5.8	
75	753 001 012	0.464	152	70	75	6.8	
90	753 001 013	0.530	168	79	90	8.2	
110	753 001 014	1.282	193	82	110	10.0	
125	753 001 015	1.290	216	87	125	11.4	
140	753 001 016	2.230	232	92	140	12.7	
160	753 001 017	3.424	258	98	160	14.6	
180	753 001 018	5.000	290	105	180	16.4	
200	753 001 019	6.925	317	112	200	18.2	
225	753 001 020	9.770	350	120	225	20.5	
250	753 001 021	9.230	375	130	250	22.7	
280	753 001 022	15.487	430	150	280	25.4	
315	753 001 023	23.950	470	150	315	28.6	
*	355	753 001 024	53.300	900	250	533	32.3
*	400	753 001 025	71.900	980	250	600	36.4
*	450	753 001 026	97.300	1070	250	675	40.9
*	500	753 001 027	134.000	1200	280	750	45.5
*	560	753 001 028	179.300	1290	280	840	50.9
*	630	753 001 029	243.200	1400	280	945	57.3
*	710	753 001 030	469.943	2200	570	1630	
*	800	753 001 031	577.131	2200	480	1720	

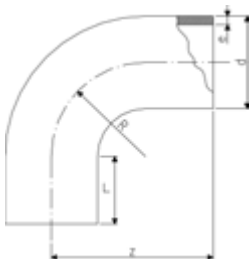

Bend 90° PE100 SDR17

- Long spigot version
- 5 bar Gas / 10 bar Water
- bends made out of seamless pipe shall not be shortened
- * made out of seamless pipe. This shall not be shortened.

d (mm)	Code	Weight (kg)	L (mm)	R (mm)	z (mm)	e (mm)	
90	753 000 813	0.520	79	90	168	5.4	
110	753 000 814	0.942	82	110	193	6.6	
125	753 000 815	1.300	87	125	216	7.4	
140	753 000 816	1.789	92	140	232	8.3	
160	753 000 817	2.410	98	160	258	9.5	
180	753 000 818	4.000	105	180	290	10.7	
200	753 000 819	6.500	112	200	317	11.9	
225	753 000 820	6.414	120	225	350	13.4	
250	753 000 821	9.940	130	250	375	14.8	
280	753 000 822	13.795	150	280	430	16.6	
315	753 000 823	24.000	150	315	470	18.7	
*	355	753 000 824	36.700	250	533	900	21.1
*	400	753 000 825	49.700	250	600	980	23.7
*	450	753 000 826	66.600	250	675	1070	26.7
*	500	753 000 827	87.400	280	750	1200	29.7

table continued on the next page

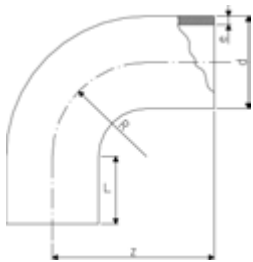

	d (mm)	Code	Weight (kg)	L (mm)	R (mm)	z (mm)	e (mm)
*	560	753 000 828	116.000	280	840	1290	33.2
*	630	753 000 829	159.600	280	945	1400	37.4
*	710	753 000 830	317.382	570	1630	2200	
*	800	753 000 831	389.859	480	1720	2200	

Bend 90° PE100 SDR17



Model:

- Conventional butt-welding according to DVS 2207
- Production process: segment welded
- Segment-welded fittings have a pressure reduction factor of 0.8
- 8 bar water
- Long spigot version

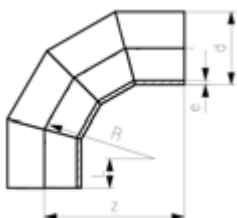

	d (mm)	Code	Weight (kg)	z (mm)	L (mm)	R (mm)	e (mm)
	710	753 002 001	202.419	1415	350	1065	42.1
	800	753 002 002	279.918	1550	350	1200	47.4
	900	753 002 003	386.595	1700	350	1350	53.3
	1000	753 002 004	534.660	1900	400	1500	59.3

Bend 60° PE100 SDR11



- bends made out of seamless pipe shall not be shortened
- made out of seamless pipe
- Long spigot version
- 10 bar Gas / 16 bar Water

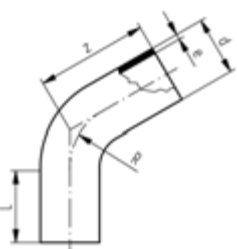

	d (mm)	Code	Weight (kg)	R (mm)	L (mm)	z (mm)	e (mm)
	32	753 071 008	0.070	48	80	128	2.9
	40	753 071 009	0.120	60	80	135	3.7
	50	753 071 010	0.240	75	100	158	4.6
	63	753 071 011	0.420	95	100	173	5.8
	75	753 071 012	0.600	113	100	182	6.8
	90	753 071 013	0.900	135	100	193	8.2
	110	753 071 014	1.780	165	150	270	10.0
	125	753 071 015	2.500	188	150	283	11.4
	140	753 071 016	2.700	210	150	296	12.7
	160	753 071 017	4.574	240	150	313	14.6
	180	753 071 018	4.900	270	150	330	16.4
	200	753 071 019	6.400	300	150	348	18.2
	225	753 071 020	8.600	338	150	370	20.5
	250	753 071 021	14.500	375	250	500	22.7
	280	753 071 022	19.100	420	250	530	25.4
	315	753 071 023	25.600	473	250	612	28.6
	355	753 071 024	41.700	533	300	690	32.3
	400	753 071 025	55.800	600	300	730	36.4
	450	753 071 026	76.000	675	300	780	40.9
	500	753 071 027	104.600	750	350	880	45.5
	560	753 071 028	139.500	840	350	930	50.9
	630	753 071 029	188.500	945	350	1000	57.3



Bend 60° PE100 SDR17/17,6

- bends made out of seamless pipe shall not be shortened
- Long spigot version
- 5 bar Gas / 10 bar Water
- made out of seamless pipe

d (mm)	Code	Weight (kg)	e (mm)	R (mm)	z (mm)	L (mm)
90	753 070 813	0.600	5.4	135	193	100
110	753 070 814	1.280	6.6	165	270	150
125	753 070 815	1.300	7.4	187	283	150
140	753 070 816	1.800	8.3	210	296	150
160	753 070 817	3.160	9.5	240	313	150
180	753 070 818	3.190	10.7	270	330	150
200	753 070 819	4.200	11.9	300	348	150
225	753 070 820	5.600	13.4	337	370	150
250	753 070 821	9.250	14.8	375	500	250
280	753 070 822	15.000	16.6	420	530	250
315	753 070 823	19.500	18.7	472	612	250
355	753 070 824	30.100	21.1	532	690	300
400	753 070 825	38.200	23.7	600	730	300
450	753 070 826	53.700	26.7	675	780	300
500	753 070 827	73.900	29.7	750	880	350
560	753 070 828	98.200	33.2	840	930	350
630	753 070 829	132.300	37.4	945	1000	350

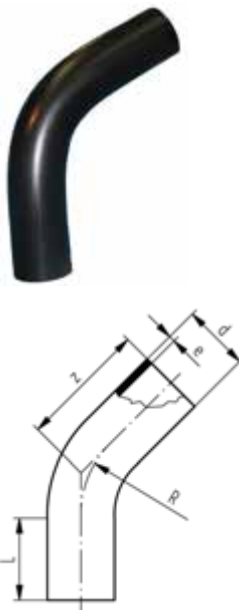

Bend 45° PE100 SDR11

- Long spigot version
- 10 bar Gas / 16 bar Water
- made out of seamless pipe
- bends made out of seamless pipe shall not be shortened

d (mm)	Code	Weight (kg)	e (mm)	z (mm)	R (mm)	L (mm)
32	753 051 008	0.077	2.9	120	48	80
40	753 051 009	0.120	3.7	120	60	80
50	753 051 010	0.240	4.6	149	75	100
63	753 051 011	0.360	5.8	161	95	100
75	753 051 012	0.560	6.8	168	113	100
90	753 051 013	0.760	8.2	177	135	100
110	753 051 014	1.700	10.0	243	165	150
125	753 051 015	2.186	11.4	253	188	150
140	753 051 016	2.800	12.7	262	210	150
160	753 051 017	3.800	14.6	274	240	160
180	753 051 018	5.140	16.4	287	270	150
200	753 051 019	7.058	18.2	299	300	150
225	753 051 020	7.400	20.5	315	338	150
250	753 051 021	13.000	22.7	440	375	250
280	753 051 022	22.000	25.4	460	420	250
315	753 051 023	24.930	28.6	535	473	250
355	753 051 024	39.500	32.3	620	533	300
400	753 051 025	48.500	36.4	650	600	300
450	753 051 026	69.800	40.9	680	675	300
500	753 051 027	96.300	45.5	760	750	350
560	753 051 028	129.800	50.9	800	840	350
630	753 051 029	174.000	57.3	870	945	350



Bend 45° PE100 SDR17/17,6

Model:

- Conventional butt-welding according to DVS 2207
- Production process: segment welded
- Segment-welded fittings have a pressure reduction factor of 0.8
- 8 bar water
- Long spigot version

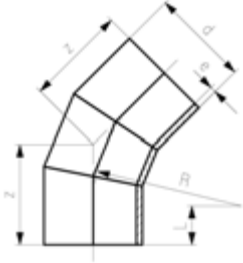

d (mm)	Code	Weight (kg)	z (mm)	L (mm)	R (mm)	e (mm)
710	753 003 001	129.998	792	350	1065	42.1
800	753 003 002	176.165	847	350	1200	47.4
900	753 003 003	252.638	960	350	1350	53.3
1000	753 003 004	332.107	1022	400	1500	59.3



Bend 45° PE100 SDR17/17,6

- Long spigot version
- 5 bar Gas / 10 bar Water
- made out of seamless pipe
- bends made out of seamless pipe shall not be shortened

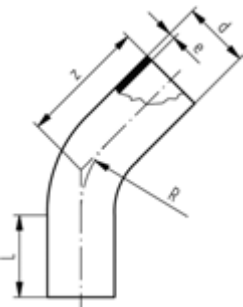

d (mm)	Code	Weight (kg)	R (mm)	e (mm)	z (mm)	L (mm)
90	753 050 813	0.600	135	5.4	177	100
110	753 050 814	1.208	165	6.6	243	150
125	753 050 815	1.540	188	7.4	253	150
140	753 050 816	1.720	210	8.3	262	150
160	753 050 817	2.200	240	9.5	274	150
180	753 050 818	3.000	270	10.7	287	150
200	753 050 819	3.700	300	11.9	299	150
225	753 050 820	5.000	338	13.4	315	150
250	753 050 821	10.691	375	14.8	440	250
280	753 050 822	15.000	420	16.6	460	250
315	753 050 823	17.800	473	18.7	535	250
355	753 050 824	25.600	533	21.1	620	300
400	753 050 825	36.600	600	23.7	650	300
450	753 050 826	45.300	675	26.7	680	300
500	753 050 827	62.400	750	29.7	760	350
560	753 050 828	81.900	840	33.2	800	350
630	753 050 829	62.400	945	37.4	870	350

Bend 30° PE100 SDR11



- Long spigot version
- 10 bar Gas / 16 bar Water
- made out of seamless pipe
- bends made out of seamless pipe shall not be shortened

d (mm)	Code	Weight (kg)	L (mm)	z (mm)	e (mm)	R (mm)
32	753 061 008	0.077	80	113	2.9	48
40	753 061 009	0.120	80	116	3.7	60
50	753 061 010	0.200	100	140	4.6	75
63	753 061 011	0.400	100	150	5.8	95
75	753 061 012	0.520	100	155	6.8	113
90	753 061 013	0.760	100	160	8.2	135
110	753 061 014	1.689	150	219	10.0	165
125	753 061 015	2.096	150	225	11.4	188
140	753 061 016	2.200	150	231	12.7	210
160	753 061 017	3.650	150	239	14.6	240
180	753 061 018	4.782	150	247	16.4	270
200	753 061 019	5.777	150	255	18.2	300
225	753 061 020	6.300	150	266	20.5	338
250	753 061 021	13.100	250	385	22.7	375
280	753 061 022	16.300	250	400	25.4	420
315	753 061 023	21.850	250	460	28.6	473
355	753 061 024	34.900	300	540	32.3	533
400	753 061 025	45.900	300	560	36.4	600
450	753 061 026	60.200	300	580	40.9	675
500	753 061 027	83.300	350	630	45.5	750
560	753 061 028	108.600	350	680	50.9	840
630	753 061 029	148.300	350	730	57.3	945

Bend 30° PE100 SDR17/17,6



- Long spigot version
- 5 bar Gas / 10 bar Water
- made out of seamless pipe
- bends made out of seamless pipe shall not be shortened

d (mm)	Code	Weight (kg)	z (mm)	L (mm)	R (mm)	e (mm)
90	753 060 813	0.500	160	100	135	5.4
110	753 060 814	1.060	219	150	165	6.6
125	753 060 815	1.100	225	150	188	7.4
140	753 060 816	1.720	231	150	210	8.3
160	753 060 817	2.565	239	150	240	9.5
180	753 060 818	3.389	247	150	270	10.7
200	753 060 819	4.213	255	150	300	11.9
225	753 060 820	7.540	266	150	338	13.4
250	753 060 821	11.600	385	250	375	14.8
280	753 060 822	12.800	400	250	420	16.6
315	753 060 823	25.000	460	250	473	18.7
355	753 060 824	22.700	540	300	533	21.1
400	753 060 825	29.800	560	300	600	23.7
450	753 060 826	39.100	580	300	675	26.7
500	753 060 827	54.000	650	350	750	29.7
560	753 060 828	70.300	680	350	840	33.2
630	753 060 829	95.800	730	350	945	37.4



Bend 22° PE100 SDR11

- Long spigot version
- 10 bar Gas / 16 bar Water
- made out of seamless pipe
- bends made out of seamless pipe shall not be shortened

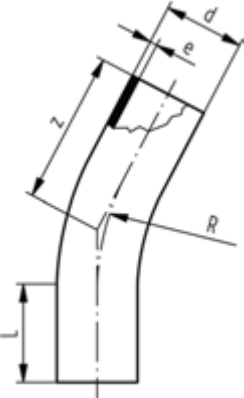

d (mm)	Code	Weight (kg)	z (mm)	L (mm)	R (mm)	e (mm)
32	753 081 008	0.077	113	80	48	2.9
40	753 081 009	0.120	116	80	60	3.7
50	753 081 010	0.200	140	100	75	4.6
63	753 081 011	0.400	150	100	95	5.8
75	753 081 012	0.520	155	100	113	6.8
90	753 081 013	0.760	160	100	135	8.2
110	753 081 014	1.500	219	150	165	10.0
125	753 081 015	2.000	225	150	188	11.4
140	753 081 016	2.200	231	150	210	12.7
160	753 081 017	3.300	239	150	240	14.6
180	753 081 018	3.700	247	150	270	16.4
200	753 081 019	4.750	255	150	300	18.2
225	753 081 020	6.300	266	150	338	20.5
250	753 081 021	14.015	385	250	375	22.7
280	753 081 022	18.510	400	250	420	25.4
315	753 081 023	21.845	460	250	473	28.6
355	753 081 024	34.900	540	300	533	32.3
400	753 081 025	45.900	560	300	600	36.4
450	753 081 026	60.200	580	300	675	40.9
500	753 081 027	83.300	650	350	750	45.5
560	753 081 028	108.600	680	350	840	50.9
630	753 081 029	148.300	730	350	945	57.3



Bend 22° PE100 SDR17/17,6

- Long spigot version
- 5 bar Gas / 10 bar Water
- made out of seamless pipe
- bends made out of seamless pipe shall not be shortened

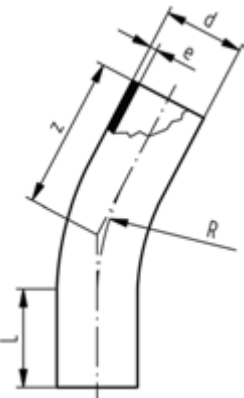

d (mm)	Code	Weight (kg)	R (mm)	e (mm)	z (mm)	L (mm)
90	753 080 813	0.500	135	5	160	100
110	753 080 814	1.060	165	7	219	150
125	753 080 815	1.100	188	7	225	150
140	753 080 816	1.720	210	8	231	150
160	753 080 817	1.900	240	10	239	150
180	753 080 818	3.318	270	11	247	150
200	753 080 819	3.200	300	12	255	150
225	753 080 820	5.431	338	13	266	150
250	753 080 821	9.904	375	15	385	250
280	753 080 822	12.800	420	17	400	250
315	753 080 823	14.144	473	19	460	250
355	753 080 824	22.700	533	21	540	300
400	753 080 825	29.800	600	24	560	300
450	753 080 826	39.100	675	27	580	300
500	753 080 827	54.000	750	30	650	350
560	753 080 828	70.300	840	33	680	350
630	753 080 829	95.800	945	37	730	350

Bend 11° PE100 SDR11



- Long spigot version
- 10 bar Gas / 16 bar Water
- made out of seamless pipe
- bends made out of seamless pipe shall not be shortened

d (mm)	Code	Weight (kg)	L (mm)	e (mm)	z (mm)	R (mm)
32	753 091 008	0.077	80	3	113	48
40	753 091 009	0.120	80	4	116	60
50	753 091 010	0.200	100	5	140	75
63	753 091 011	0.400	100	6	150	95
75	753 091 012	0.520	100	7	155	113
90	753 091 013	0.760	100	8	160	135
110	753 091 014	1.500	150	10	219	165
125	753 091 015	2.000	150	11	225	188
140	753 091 016	2.200	150	13	231	210
160	753 091 017	3.300	150	15	239	240
180	753 091 018	3.700	150	16	247	270
200	753 091 019	4.750	150	18	255	300
225	753 091 020	7.773	150	21	266	338
250	753 091 021	13.100	250	23	385	375
280	753 091 022	16.300	250	25	400	420
315	753 091 023	21.845	250	29	460	473
355	753 091 024	34.900	300	32	540	533
400	753 091 025	45.900	300	36	560	600
450	753 091 026	60.200	300	41	580	675
500	753 091 027	83.300	350	46	650	750
560	753 091 028	108.600	350	51	680	840
630	753 091 029	148.300	350	57	730	945

Bend 11° PE100 SDR17/17,6



- Long spigot version
- 5 bar Gas / 10 bar Water
- made out of seamless pipe
- bends made out of seamless pipe shall not be shortened

d (mm)	Code	Weight (kg)	z (mm)	L (mm)	R (mm)	e (mm)
90	753 090 813	0.500	160	100	135	5
110	753 090 814	1.060	219	150	165	7
125	753 090 815	1.100	225	150	188	7
140	753 090 816	1.720	231	150	210	8
160	753 090 817	2.653	239	150	240	10
180	753 090 818	2.500	247	150	270	11
200	753 090 819	4.308	255	150	300	12
225	753 090 820	7.540	266	150	338	13
250	753 090 821	11.600	385	250	375	15
280	753 090 822	12.800	400	250	420	17
315	753 090 823	25.000	460	250	473	19
355	753 090 824	22.700	540	300	533	21
400	753 090 825	29.800	560	300	600	24
450	753 090 826	39.100	580	300	675	27
500	753 090 827	54.000	650	350	750	30
560	753 090 828	70.300	680	350	840	33
630	753 090 829	95.800	730	350	945	37

Tees

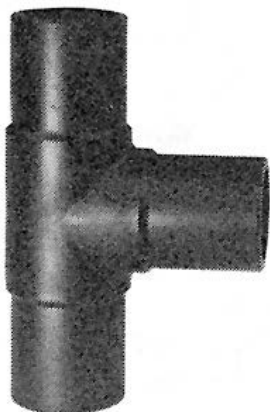

Tee 90° equal PE100 SDR11

- Long spigot version
- 10 bar Gas / 16 bar Water
- * With welded pipes
- * Segment welded and reinforced
- * No pressure reduction factor

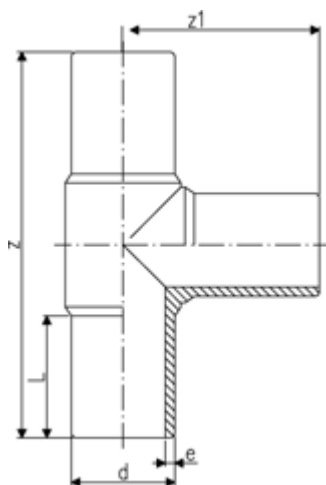

d (mm)	Code	Weight (kg)	z (mm)	z1 (mm)	L (mm)	e (mm)	
20	753 201 006	0.038	150	75	52	3.0	
25	753 201 007	0.054	160	80	52	3.0	
32	753 201 008	0.077	170	85	54	3.0	
40	753 201 009	0.130	190	95	57	3.7	
50	753 201 010	0.214	210	105	63	4.6	
63	753 201 011	0.376	230	115	65	5.8	
75	753 201 012	0.599	264	132	72	6.8	
90	753 201 013	1.021	300	150	81	8.2	
110	753 201 014	1.612	330	165	86	10.0	
125	753 201 015	2.420	366	183	92	11.4	
140	753 201 016	3.090	393	193	92	12.7	
160	753 201 017	4.403	420	210	102	14.6	
180	753 201 018	6.014	460	230	107	16.4	
200	753 201 019	8.480	500	250	117	18.2	
225	753 201 020	11.507	540	270	122	20.5	
250	753 201 001	14.099	575	288	130	22.7	
280	753 200 902	18.670	615	308	139	25.4	
315	753 200 903	26.150	695	346	150	28.6	
355	753 200 024	38.900	820	410	170	32.3	
400	753 200 025	53.400	900	450	190	36.4	
450	753 200 026	73.400	980	490	200	40.9	
500	753 200 027	98.500	1070	535	220	45.5	
*	560	753 200 908	153.300	1510	755	230	50.9
*	630	753 200 909	205.500	1630	815	250	57.3
*	710	753 201 120	318.698	1720	860	450	64.5
*	800	753 201 121	409.142	1780	890	450	72.6

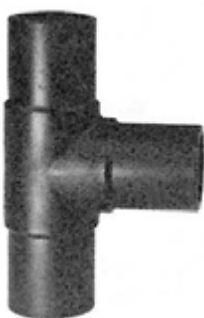

Tee 90° equal PE100 SDR17/17,6

- Long spigot version
- * Segment welded and reinforced
- * With welded pipes
- * No pressure reduction factor

Model:

- 5 bar Gas / 10 bar Water

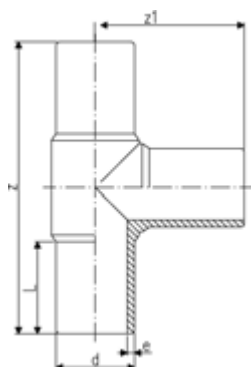

d (mm)	Code	Weight (kg)	z (mm)	z1 (mm)	L (mm)	e (mm)
90	753 200 813	0.777	300	150	80	5.4
110	753 200 814	1.231	330	165	86	6.6
125	753 200 815	1.690	366	183	92	7.4
140	753 200 816	2.202	396	196	92	8.3
160	753 200 817	3.201	428	214	104	9.5
180	753 200 818	4.287	460	230	105	10.7
200	753 200 819	5.889	500	250	115	11.9
225	753 200 820	7.886	540	270	122	13.4
250	753 200 821	10.000	575	288	130	14.8
280	753 200 802	13.350	615	308	139	16.6
315	753 200 803	17.985	695	346	150	18.7
355	753 200 124	26.100	820	410	170	21.1
400	753 200 125	35.700	900	450	190	23.7

table continued on the next page

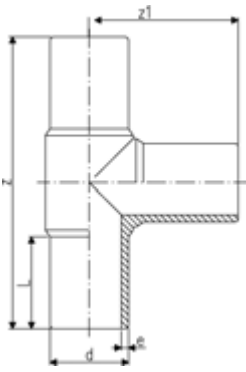

d (mm)	Code	Weight (kg)	z (mm)	z1 (mm)	L (mm)	e (mm)	
450	753 200 126	49.400	980	490	200	26.7	
500	753 200 127	66.100	1070	535	220	29.7	
*	560	753 200 808	99.200	1510	755	230	33.2
*	630	753 200 809	132.700	1630	815	250	37.4
*	710	753 201 920	219.870	1720	860	450	42.1
*	800	753 201 921	281.495	1780	890	450	47.4



Tee 90° equal PE100 SDR17/17,6

Model:

- Conventional butt-welding according to DVS 2207
- Production process: segment welded
- Does not conform to pressure rating. Pressure reduction factor of 0.5
- 5 bar water
- Long spigot version

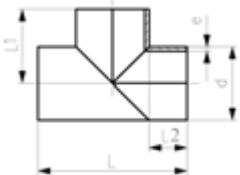

d (mm)	Code	Weight (kg)	L (mm)	L1 (mm)	L2 (mm)	e (mm)
710	753 202 810	158.180	1410	705	350	42.1
800	753 202 811	210.302	1500	750	350	47.4
900	753 202 812	302.118	1700	850	400	53.3
1000	753 202 813	457.054	2040	1020	520	59.3



Tee 45° equal PE100 SDR11

- Long spigot version

d (mm)	Code	Weight (kg)	z (mm)	z1 (mm)	L (mm)	e (mm)
50	753 251 010	0.300	218	139	56	4.6
63	753 251 011	0.440	255	158	63	6.2
75	753 251 012	0.800	301	190	70	6.8
90	753 251 013	1.373	368	234	79	8.2
110	753 251 014	1.800	395	260	82	10.0

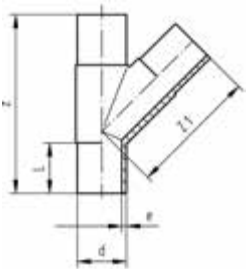



Tee 45° equal PE100 SDR17/17,6

- 5 bar Gas / 10 bar Water
- Long spigot version

d (mm)	Code	Weight (kg)	z (mm)	z1 (mm)	L (mm)	e (mm)
90	753 251 063	0.800	368	234	79	5.4
110	753 251 064	1.400	395	260	82	6.6



Tee 90° reduced PE100 SDR11

Model:

- moulded
- 10 bar Gas / 16 bar Water
- Long spigot version

d (mm)	d1 (mm)	Code	Weight (kg)	z (mm)	z1 (mm)	L (mm)	L1 (mm)	e (mm)	e1 (mm)
63	32	753 201 022	0.300	218	86	65	47	5.8	3.0
63	40	753 201 026	0.312	230	107	67	58	5.8	3.7
63	50	753 201 021	0.300	218	100	65	59	5.8	4.6
75	32	753 201 023	0.455	248	98	73	46	6.8	3.0
75	50	753 201 024	0.485	248	109	73	58	6.8	4.6
75	63	753 201 025	0.520	248	118	73	65	6.8	5.8
90	50	753 201 027	0.794	280	120	79	55	8.2	4.6
90	63	753 201 029	0.775	282	127	79	63	8.2	5.8
90	75	753 201 055	0.800	286	132	80	75	8.2	6.8
110	63	753 201 028	1.409	322	148	87	63	10.0	5.8
110	75	753 201 031	1.221	305	148	83	68	10.0	6.8
110	90	753 201 032	1.275	322	164	86	79	10.0	8.2
125	90	753 201 048	1.717	332	168	109	89	11.4	8.2
125	110	753 201 033	1.909	340	167	90	83	11.4	10.0
160	63	753 201 034	2.680	416	174	105	65	14.6	5.8
160	75	753 201 035	2.676	344	179	101	76	14.6	6.8
160	90	753 201 036	2.775	415	190	101	79	14.6	8.2
160	110	753 201 037	3.300	415	200	101	82	14.6	10.0
180	90	753 201 049	4.410	420	200	136	97	16.4	8.2
180	110	753 201 050	4.379	430	206	145	101	16.4	10.0
180	160	753 201 038	4.715	414	203	105	94	16.4	14.6
200	63	753 201 073	7.300	503	196	122	63	18.2	5.8
200	90	753 201 074	9.730	500	216	122	79	18.2	8.2
200	110	753 201 075	7.120	505	219	122	82	18.2	10.0
200	160	753 201 076	9.730	500	237	122	98	18.2	14.6
225	75	753 201 039	9.880	560	219	120	70	20.5	6.8
225	90	753 201 040	6.633	555	228	120	80	20.5	8.2
225	110	753 201 041	10.010	559	238	120	82	20.5	10.0
225	160	753 201 042	8.095	555	258	120	98	20.5	14.6
225	180	753 201 043	9.375	559	284	120	105	20.5	16.4
250	110	753 201 078	11.820	584	284	130	82	22.7	10.0
250	160	753 201 079	12.302	586	266	127	98	22.7	14.6

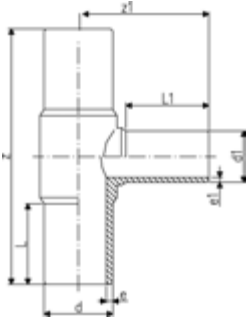
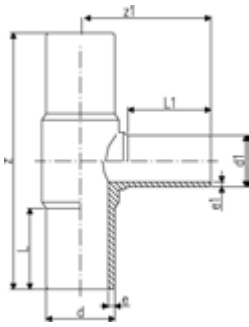

table continued on the next page



d (mm)	d1 (mm)	Code	Weight (kg)	z (mm)	z1 (mm)	L (mm)	L1 (mm)	e (mm)	e1 (mm)
315	110	753 201 051	15.300	705	282	150	82	28.6	10.0
315	160	753 201 052	22.998	705	301	150	102	28.6	14.6
315	225	753 201 053	20.011	658	335	170	145	28.6	20.5
315	250	753 201 054	24.243	695	331	150	130	28.6	22.7

Tee 90° reduced PE100 SDR11

Model:

- with welded reducer
- 10 bar Gas / 16 bar Water
- Long spigot version



d (mm)	d1 (mm)	Code	Weight (kg)	z1 (mm)	z (mm)	L (mm)	L1 (mm)	e (mm)	e1 (mm)
25	20	753 201 002	0.053		160	52	52	3.0	3.0
32	20	753 201 003	0.094	105	170	54	52	3.0	3.0
32	25	753 201 004	0.098	110	170	54	52	3.0	3.0
40	20	753 201 005	0.124	120	190	57	52	3.7	3.0
40	25	753 201 069	0.160	120	190	57	52	3.7	3.0
40	32	753 201 070	0.160	120	190	57	52	3.7	3.0
50	20	753 201 072	0.252	140	210	63	52	4.6	3.0
50	25	753 201 077	0.203	130	210	63	52	4.6	3.0
50	32	753 201 080	0.207	130	210	63	53	4.6	3.0
50	40	753 201 081	0.224	130	210	63	57	4.6	3.7
63	32	753 201 082	0.359	140	230	65	53	5.8	3.0
63	40	753 201 116	0.480	145	230	65	57	5.8	3.7
75	40	753 201 084	0.603	180	264	72	57	6.8	3.7
125	63	753 201 085	2.359	225	366	92	61	11.4	5.8
125	75	753 201 086	2.434	235	366	92	72	11.4	6.8
140	75	753 201 087	3.038	230	396	92	70	12.7	6.8
140	90	753 201 089	3.092	235	396	92	79	12.7	8.2
140	110	753 201 090	3.208	240	396	92	82	12.7	10.0
140	125	753 201 091	4.170	240	396	92	90	12.7	11.4
160	125	753 201 092	4.544	265	420	102	92	14.6	11.4
160	140	753 201 093	5.895	270	420	102	96	14.6	12.7
180	125	753 201 094	6.111	285	460	107	92	16.4	11.4
180	140	753 201 095	6.317	295	460	107	110	16.4	12.7
200	125	753 201 096	8.424	295	500	117	92	18.2	11.4
200	140	753 201 097	10.570	310	500	117	110	18.2	12.7
200	180	753 201 098	9.031	310	500	117	110	18.2	16.4
225	125	753 201 099	11.260	320	540	122	92	20.5	11.4
225	140	753 201 100	14.574	335	540	122	110	20.5	12.7
225	200	753 201 101	14.925	340	540	122	117	20.5	18.2
250	180	753 201 102	14.327	350	576	130	105	22.7	16.4
250	200	753 201 103	19.220	360	576	130	112	22.7	18.2
250	225	753 201 104	15.240	390	576	130	120	22.7	20.5
280	200	753 201 105	24.520	420	616	139	112	25.4	18.2
280	225	753 201 106	21.755	420	616	139	120	25.4	20.5
280	250	753 201 107	21.055	420	616	139	130	25.4	22.7
315	200	753 201 108	33.672	470	690	150	134	28.6	18.2
315	280	753 201 109	34.950	480	690	150	139	28.6	25.4
355	250	753 201 110	48.900	530	818	165	130	32.3	22.7
355	280	753 201 111	49.300	480	818	165	139	32.3	25.4

table continued on the next page

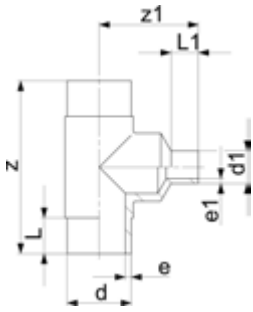

d (mm)	d1 (mm)	Code	Weight (kg)	z1 (mm)	z (mm)	L (mm)	L1 (mm)	e (mm)	e1 (mm)
355	315	753 201 112	49.690	480	818	165	150	32.3	28.6
400	280	753 201 113	52.915	530	910	180	139	36.4	25.4
400	315	753 201 114	53.625	580	910	180	150	36.4	28.6
400	355	753 201 115	54.075	675	910	180	165	36.4	32.3

Tee 90° reduced PE100 SDR17/17.6

- moulded
- Long spigot version
- 5 bar Gas / 10 bar Water

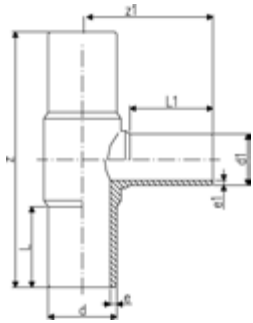

d (mm)	d1 (mm)	Code	Weight (kg)	z (mm)	z1 (mm)	L (mm)	L1 (mm)	e (mm)	e1 (mm)
90	50	753 201 827	0.630	275	117	79	55	5.4	3.0
90	63	753 200 829	0.560	275	123	79	63	5.4	3.8
110	63	753 200 828	1.010	318	147	82	63	6.6	3.8
110	75	753 200 831	0.891	315	152	84	70	6.6	4.5
110	90	753 200 832	0.941	318	158	82	79	6.6	5.4
125	110	753 200 833	1.399	334	168	84	83	7.4	6.6
160	63	753 200 834	1.950	330	130	86	63	9.5	3.8
160	75	753 200 835	1.932	343	180	98	74	9.5	4.5
160	90	753 200 836	1.972	410	188	98	79	9.5	5.4
160	110	753 200 837	2.716	410	195	98	82	9.5	6.6
180	90	753 200 844	3.250	422	204	134	97	10.7	5.4
180	160	753 200 838	3.557	411	205	105	94	10.7	9.5
200	63	753 201 873	6.800	500	190	122	63	11.9	3.8
200	90	753 201 874	6.900	500	207	122	79	11.9	5.4
200	110	753 201 875	5.097	500	215	122	82	11.9	6.6
200	160	753 201 876	7.400	500	234	122	98	11.9	9.5
225	75	753 200 839	7.128	555	277	120	70	13.4	4.5
225	90	753 200 840	4.732	555	226	127	80	13.4	5.4
225	110	753 200 841	4.700	555	235	127	82	13.4	6.6
225	140	753 200 855	8.780	286	132	80	75	5.4	4.5
225	160	753 200 842	5.922	555	253	127	98	13.4	9.5
225	180	753 200 843	7.211	550	280	120	105	13.4	10.7
250	110	753 201 878	9.400	575	242	130	82	14.8	6.6
250	160	753 201 879	9.800	575	261	130	98	14.8	9.5
315	110	753 200 851	15.621	695	277	150	82	18.7	6.6
315	160	753 200 852	12.200	695	296	150	102	18.7	9.5
315	225	753 200 853	14.869	650	335	170	145	18.7	13.4
315	250	753 200 854	15.500	695	325	150	130	18.7	14.8

Tee 90° reduced PE100 SDR17/17.6



Model:

- with welded reducer
- 5 bar Gas / 10 bar Water
- Long spigot version

d (mm)	d1 (mm)	Code	Weight (kg)	z (mm)	z1 (mm)	L1 (mm)	L (mm)	e (mm)	e1 (mm)
125	63	753 200 801	1.752	366	215	61	92	7	4
125	75	753 200 810	1.806	366	235	72	92	7	5
125	90	753 200 811	1.712	366	235	80	92	7	5
140	75	753 200 812	2.820	396	240	70	92	8	5
140	90	753 200 822	2.211	396	240	78	92	8	5
140	110	753 200 823	2.266	396	235	82	92	8	7
140	125	753 200 824	2.317	396	240	87	92	8	7
160	125	753 200 825	3.311	428	265	90	104	10	5
160	140	753 200 826	3.416	428	280	96	104	10	8
180	110	753 200 827	4.410	460	285	92	105	11	7
180	125	753 200 845	4.460	460	285	90	105	11	7
180	140	753 200 846	4.483	460	305	110	105	11	8
200	125	753 200 847	5.886	500	310	92	115	12	7
200	140	753 200 848	7.200	500	315	110	115	12	8
200	180	753 200 849	6.900	500	315	110	115	12	11
225	125	753 200 850	7.937	540	320	92	122	13	7
225	140	753 200 855	8.780	540	345	110	122	13	8
225	200	753 200 856	9.064	540	335	115	122	13	12
250	180	753 200 857	15.000	576	340	105	130	15	11
250	200	753 200 858	15.440	576	350	112	130	15	12
250	225	753 200 859	15.620	576	370	120	130	15	13
280	200	753 200 860	19.200	616	400	112	139	17	12
280	225	753 200 861	19.500	616	400	120	139	17	13
280	250	753 200 862	20.120	616	400	130	139	17	15
315	200	753 200 863	18.700	690	480	134	150	19	12
315	280	753 200 864	26.940	690	480	139	150	19	17
355	250	753 200 865	35.770	818	480	130	165	21	15
355	280	753 200 866	36.330	818	480	139	165	21	17
355	315	753 200 867	37.740	818	490	150	165	21	19
400	280	753 200 868	48.330	910	540	139	180	24	17
400	315	753 200 869	48.880	910	580	150	180	24	19
400	355	753 200 870	50.020	910	675	165	180	24	21



T 45° reduced PE100 SDR11

Model:

- 10 bar Gas / 16 bar Water
- Long spigot version

d1	d	Code	Weight	z	z1	L	e
(mm)	(mm)		(kg)	(mm)	(mm)	(mm)	(mm)
63	50	753 251 044	0.219	252	142	65	4.9



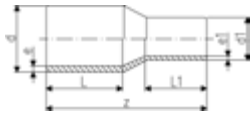

Reducer PE100 SDR17/17,6

- Long spigot version
- 5 bar Gas / 10 bar Water

d (mm)	d1 (mm)	Code	Weight (kg)	z (mm)	L1 (mm)	L (mm)	e (mm)	e1 (mm)
90	63	753 900 872	0.224	182	70	79	5.4	3.8
90	75	753 900 870	0.234	185	70	79	5.4	4.5
110	63	753 900 877	0.326	185	63	82	6.6	3.8
110	90	753 900 876	0.333	205	80	85	6.6	5.4
125	63	753 900 882	0.610	200	63	87	7.4	3.8
125	90	753 900 881	0.461	215	80	90	7.4	5.4
125	110	753 900 880	0.507	215	85	90	7.4	6.6
140	75	753 900 886	0.560	230	70	112	8.3	4.5
140	90	753 900 887	0.642	230	79	112	8.3	5.4
140	110	753 900 884	0.715	230	82	112	8.3	6.6
140	125	753 900 885	0.754	235	87	115	8.3	7.4
160	90	753 900 888	0.752	248	85	120	9.5	5.4
160	110	753 900 890	0.930	245	85	100	9.5	6.6
160	125	753 900 889	0.930	245	90	100	9.5	7.4
160	140	753 900 831	0.995	260	110	120	9.5	8.3
180	90	753 900 873	1.010	237	79	105	10.7	5.4
180	110	753 900 874	1.600	270	92	120	10.7	6.6
180	125	753 900 891	1.165	255	90	105	10.7	7.4
180	140	753 900 875	1.720	270	110	120	10.7	8.3
180	160	753 900 832	2.100	255	100	105	10.7	9.5
200	140	753 900 866	1.800	275	110	120	11.9	8.3
200	160	753 900 892	1.664	265	100	115	11.9	9.5
200	180	753 900 893	2.580	265	105	115	11.9	10.7
225	140	753 900 867	2.021	280	100	120	13.4	8.3
225	160	753 900 896	2.020	280	100	120	13.4	9.5
225	180	753 900 895	2.240	280	105	120	13.4	10.7
225	200	753 900 894	2.237	280	115	120	13.4	11.9
250	160	753 900 800	2.850	290	100	130	14.8	9.5
250	180	753 900 868	3.100	295	105	130	14.8	10.7
250	200	753 900 801	3.210	302	112	130	14.8	11.9
250	225	753 900 802	2.385	332	120	162	14.8	13.4
280	200	753 900 898	3.800	333	112	140	16.6	11.9
280	225	753 900 899	4.062	335	120	140	16.6	13.4
280	250	753 900 803	4.352	340	130	140	16.6	14.8
315	200	753 900 804	5.390	380	134	180	18.7	11.9
315	225	753 900 807	6.200	365	120	150	18.7	13.4
315	250	753 900 805	6.420	365	130	150	18.7	14.8
315	280	753 900 806	5.940	365	140	150	18.7	16.6
355	250	753 900 808	7.082	390	130	165	21.1	14.8
355	280	753 900 809	6.728	390	140	165	21.1	16.6
355	315	753 900 810	7.240	390	150	165	21.1	18.7
400	280	753 900 811	7.930	415	140	180	23.7	16.6
400	315	753 900 812	9.949	415	150	180	23.7	18.7
400	355	753 900 813	9.620	420	165	180	23.7	21.1
450	280	753 900 814	11.500	389	140	195	26.7	16.6
450	315	753 900 815	11.805	390	150	195	26.7	18.7
450	355	753 900 816	11.900	393	164	195	26.7	21.1
450	400	753 900 817	12.964	395	179	195	26.7	23.7
500	315	753 900 818	15.500	422	150	212	29.7	18.7
500	355	753 900 819	15.700	424	164	212	29.7	21.1
500	400	753 900 820	16.200	426	179	212	29.7	23.7
500	450	753 900 821	17.000	428	195	212	29.7	26.7
560	355	753 900 822	21.400	459	164	230	33.2	21.1
560	400	753 900 823	21.700	461	179	230	33.2	23.7
560	450	753 900 824	22.300	463	195	230	33.2	26.7
560	500	753 900 825	23.200	466	212	230	33.2	29.7
630	400	753 900 826	29.700	502	179	250	37.4	23.7
630	450	753 900 827	30.100	503	195	250	37.4	26.7

table continued on the next page

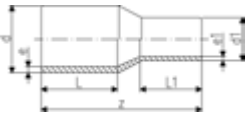

d	d1	Code	Weight	z	L	L1	e	e1
(mm)	(mm)		(kg)	(mm)	(mm)	(mm)	(mm)	(mm)
630	500	753 900 828	30.800	506	212	250	37.4	29,7
630	560	753 900 829	31.900	506	230	250	37.4	33,3
710	500	753 900 833	58.796	790	300	300	42.1	29,7
710	560	753 900 834	60.578	770	300	300	42.1	33,2
710	630	753 900 835	62.448	740	300	300	42.1	37,4
800	560	753 900 836	75.842	800	300	300	47.4	33,2
800	630	753 900 837	78.255	780	300	300	47.4	37,4
800	710	753 900 838	80.504	750	300	300	47.4	42,1
900	630	753 900 839	99.282	820	300	300	53.3	37,4
900	710	753 900 840	100.908	790	300	300	53.3	42,1
900	800	753 900 841	103.578	760	300	300	53.3	47,4
1000	710	753 900 842	124.232	820	300	300	59.3	42,1
1000	800	753 900 843	125.277	780	300	300	59.3	47,4
1000	900	753 900 844	126.638	740	300	300	59.3	53,3



Reducer PE100 SDR11

- Long spigot version
- 10 bar Gas / 16 bar Water

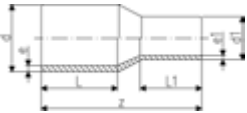

d	d1	Code	Weight	z	L	L1	e	e1
(mm)	(mm)		(kg)	(mm)	(mm)	(mm)	(mm)	(mm)
25	20	753 901 038	0.022	115	53	52	3.0	3,0
32	20	753 901 042	0.027	122	55	53	3.0	3,0
32	25	753 901 041	0.033	122	55	53	3.0	3,0
40	20	753 901 048	0.043	127	56	50	3.7	3,0
40	25	753 901 047	0.045	128	55	50	3.7	3,0
40	32	753 901 046	0.047	128	55	52	3.7	3,0
50	20	753 901 055	0.064	147	62	50	4.6	3,0
50	25	753 901 054	0.069	139	62	50	4.6	3,0
50	32	753 901 053	0.067	140	62	54	4.6	3,0
50	40	753 901 052	0.079	138	62	55	4.6	3,7
63	32	753 901 060	0.113	150	65	53	5.8	3,0
63	40	753 901 059	0.122	150	65	57	5.8	3,7
63	50	753 901 058	0.128	150	65	62	5.8	4,6
75	40	753 901 063	0.185	170	72	51	6.8	3,7
75	50	753 901 064	0.188	170	72	65	6.8	4,6
75	63	753 901 065	0.209	170	72	65	6.8	5,8
90	50	753 901 072	0.289	190	81	61	8.2	4,6
90	63	753 901 071	0.316	190	81	65	8.2	5,8
90	75	753 901 070	0.351	190	81	72	8.2	6,8
110	63	753 901 078	0.471	205	85	65	10.0	5,8
110	75	753 901 077	0.501	205	84	72	10.0	6,8
110	90	753 901 076	0.549	205	85	81	10.0	8,2
125	63	753 901 083	0.607	214	88	65	11.4	5,8
125	75	753 901 082	0.667	210	89	72	11.4	6,8
125	90	753 901 081	0.683	211	89	81	11.4	8,2
125	110	753 901 080	0.775	211	90	84	11.4	10,0
140	75	753 901 086	0.910	237	113	77	12.7	6,8
140	90	753 901 087	0.954	237	114	86	12.7	8,2
140	110	753 901 084	0.977	232	104	93	12.7	10,0
140	125	753 901 085	1.078	232	102	100	12.7	11,4
160	90	753 901 088	1.164	244	100	81	14.6	8,2
160	110	753 901 090	1.239	242	100	85	14.6	10,0
160	125	753 901 089	1.333	240	100	89	14.6	11,4
160	140	753 901 032	1.522	255	110	104	14.6	12,7
180	90	753 901 073	1.507	245	105	81	16.4	8,2
180	110	753 901 074	1.833	277	124	94	16.4	10,0
180	125	753 901 091	1.723	258	108	92	16.4	11,4
180	140	753 901 075	1.976	278	124	113	16.4	12,7
180	160	753 901 033	1.968	255	107	102	16.4	14,6
200	140	753 901 066	2.326	282	123	114	18.2	12,7

table continued on the next page

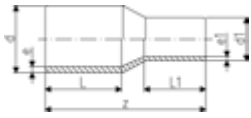

d (mm)	d1 (mm)	Code	Weight (kg)	z (mm)	L (mm)	L1 (mm)	e (mm)	e1 (mm)
200	160	753 901 092	2.391	252	104	120	18.2	14,6
200	180	753 901 034	2.724	279	124	120	18.2	16,4
225	140	753 901 067	2.900	295	132	115	20.5	12,7
225	160	753 901 096	2.891	278	120	98	20.5	14,6
225	180	753 901 095	3.244	297	128	120	20.5	16,4
225	200	753 901 094	3.538	280	124	117	20.5	18,2
250	160	753 901 000	2.385	309	150	97	22.7	14,6
250	180	753 901 068	4.299	312	150	106	22.7	16,4
250	200	753 901 001	4.766	327	155	115	22.7	18,2
250	225	753 901 002	2.385	332	130	120	22.7	20,5
280	200	753 901 098	6.850	347	140	115	25.4	18,2
280	225	753 901 099	6.112	340	140	122	25.4	20,5
280	250	753 901 003	2.385	320	137	133	25.4	22,7
315	200	753 901 004	7.522	375	170	128	28.6	18,2
315	225	753 901 097	7.790	375	150	123	28.6	20,5
315	250	753 901 005	8.360	375	150	132	28.6	22,7
315	280	753 901 012	8.800	375	150	144	28.6	25,4
355	250	753 901 013	9.100	390	165	130	32.3	22,7
355	280	753 901 014	9.500	390	165	139	32.3	25,4
355	315	753 901 015	9.900	390	165	150	32.3	28,6
400	280	753 901 016	10.420	415	180	139	36.4	25,4
400	315	753 901 017	11.130	415	180	150	36.4	28,6
400	355	753 901 018	11.600	420	180	165	36.4	32,3
450	280	753 901 019	16.200	389	195	139	40.9	25,4
450	315	753 901 020	16.700	390	195	150	40.9	28,6
450	355	753 901 022	17.500	393	195	164	40.9	32,3
450	400	753 901 024	18.500	395	195	179	40.9	36,4
500	315	753 901 025	21.900	422	212	150	45.5	28,6
500	355	753 901 026	22.600	424	212	164	45.5	32,3
500	400	753 901 027	23.600	426	212	179	45.5	36,4
500	450	753 901 029	25.100	428	212	195	45.5	40,9
560	355	753 901 030	30.100	459	230	164	50.9	32,3
560	400	753 901 039	31.000	461	230	179	50.9	36,4
560	450	753 901 040	32.400	463	230	195	50.9	40,9
560	500	753 901 043	34.100	466	230	212	50.9	45,5
630	400	753 901 044	41.900	502	250	179	57.3	36,4
630	450	753 901 045	43.100	503	250	195	57.3	40,9
630	500	753 901 049	44.700	506	250	212	57.3	45,5
630	560	753 901 050	46.800	506	250	230	57.3	50,9



Cap PE100 SDR11

- Long spigot version
- 10 bar Gas / 16 bar Water

Note:

* Fabricated fitting made from pipe

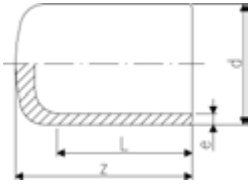

d (mm)	Code	Weight (kg)	z (mm)	L (mm)	e (mm)	
20	753 961 006	0.010	52	52	3.0	
25	753 961 007	0.015	52	52	3.0	
32	753 961 008	0.020	54	54	3.0	
40	753 961 009	0.033	57	57	3.7	
50	753 961 010	0.054	63	63	4.6	
63	753 961 011	0.086	65	65	5.8	
75	753 961 012	0.146	80	72	6.8	
90	753 961 013	0.240	90	81	8.2	
110	753 961 014	0.373	98	86	10.0	
125	753 961 015	0.546	105	92	11.4	
140	753 961 016	0.727	136	92	12.7	
160	753 961 017	1.034	120	102	14.6	
180	753 961 018	1.351	128	107	16.4	
200	753 961 019	1.845	138	115	18.2	
225	753 961 020	2.514	148	122	20.5	
250	753 961 021	3.927	205	130	22.7	
280	753 960 922	8.045	235	139	25.4	
315	753 960 923	6.861	255	150	28.6	
355	753 960 924	9.780	280	165	32.3	
400	753 960 925	13.370	310	180	36.4	
450	753 960 926	20.800	275	195	40.9	
500	753 960 927	28.400	297	212	45.5	
560	753 960 928	39.100	325	230	50.9	
*	630	753 960 929	59.700	355	250	57.3

Cap PE100 SDR17/17,6



- Long spigot version
- 5 bar Gas / 10 bar Water

Note:

* Fabricated fitting made from pipe

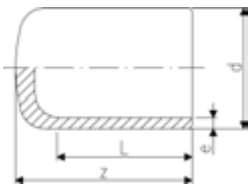

d (mm)	Code	Weight (kg)	z (mm)	L (mm)	e (mm)	
50	753 960 810	0.036	70	55	3.0	
63	753 960 811	0.058	82	63	3.8	
75	753 960 812	0.105	92	70	4.5	
90	753 960 813	0.214	90	81	5.4	
110	753 960 814	0.272	98	86	6.6	
125	753 960 815	0.487	105	92	7.4	
140	753 960 816	0.481	136	92	8.3	
160	753 960 817	0.920	120	102	9.5	
180	753 960 818	1.216	128	107	10.7	
200	753 960 819	1.687	138	115	11.9	
225	753 960 820	2.265	148	122	13.4	
250	753 960 821	2.547	205	130	14.8	
280	753 960 822	3.523	235	139	16.6	
315	753 960 823	4.758	255	150	18.7	
355	753 960 824	6.510	280	165	21.1	
400	753 960 825	9.347	310	180	23.7	
*	450	753 960 826	17.798	265	195	26.7
*	500	753 960 827	21.400	287	212	29.7
*	560	753 960 828	29.400	310	230	33.2
*	630	753 960 829	41.400	340	250	37.4

table continued on the next page

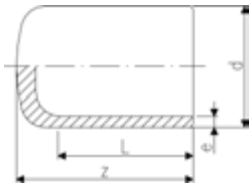

	d (mm)	Code	Weight (kg)	z (mm)	L (mm)	e (mm)
*	710	753 960 830	53.950	310	190	42.1
*	800	753 960 831	73.281	320	190	47.4
*	900	753 960 832	98.923	330	190	53.5
*	1000	753 960 833	123.925	340	190	59.3

Stop-off Valves PE100

**Valves
Accessories/Spindles**



ELGEF Plus valves



Ball valve

- PE 100 SDR 11 (ISO S5) - d20 up to d225
- 10 bar Gas / 16 bar Water
- d20 - d110 in accordance with DVGW GW336 / DVGW VP302 / DVGW W364
- d160 up to d225 are supplied with base plate and straps
- d1 = diameter of bore
- Regarding pressure rate and application local standards and regulations have to be considered
- *In accordance with ANSI B16.40

d (mm)	Code	Weight (kg)	Weight (kg)	L1 (mm)	t (mm)	H (mm)	H1 (mm)	d1 (mm)	
20	193 103 206	0.487	1	264	72	134	96	23	
25	193 103 207	0.490	1	264	72	134	96	23	
32	193 103 208	0.506	1	274	76	134	96	23	
40	193 103 209	0.616	1	301	85	142	100	30	
50	193 103 210	0.829	1	327	92	156	107	38	
63	193 103 211	1.174	1	350	101	173	114	48	
75	193 103 212	1.434	1	376	114	173	114	48	
90	193 103 213	2.918	3	439	128	240	158	68	
110	193 103 214	4.416	5	497	148	267	171	83	
125	193 103 040	4.220	4	405	112	365	280	64	
160	193 103 042	10.541	10	450	117	481	364	92	
180	193 103 043	10.524	10	540	123	481	364	92	
200	193 103 044	12.023	11	540	123	481	364	92	
*	225	193 103 045	24.400	19	877	240	755	540	120



Ball valve "full bore"

- PE 100 SDR 11 (ISO S5) - d20 up to d225
- 10 bar Gas / 16 bar Water
- d1 = diameter of bore
- For extension spindles with polygon connection
- *In accordance with ANSI B16.40, MOP 6,9 bar Gas

d (mm)	Code	Weight (kg)	d1 (mm)	L1 (mm)	H (mm)	H1 (mm)	t (mm)
110	193 104 039	8.973	92	561	359	242	100
160	193 104 042	24.254	120	645	475	325	145

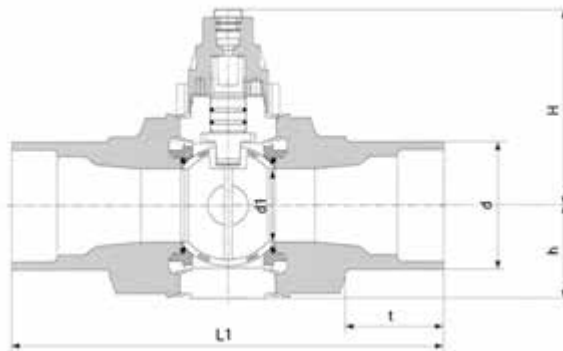



Ball valve extension spindle

- Extension spindle made out of PVC
- 100% plastic solution for a non-corrosive system

Length (mm)	Code	Weight (kg)
400	173 103 080	0.770



Ball valve accessory kit

- Extension spindle made out of PVC
- 100% plastic solution for a non-corrosive system

Article	Code	Weight (kg)
Kit	173 103 056	1.695



Ball valve operational key

- Made out of PVC
- Suitable for all dimensions

Length (mm)	Code	Weight (kg)
200	173 103 082	0.378
500	173 103 083	0.753
1240	173 103 084	1.714

Base plate with straps

Code	Weight (kg)
173 103 081	0.945

Extension Spindle



Extension spindle for ball valve Telescopic

- For ELGEF Plus ball valve d125-d225mm
- For ELGEF Plus ball valve "Full Bore" d110mm and d160mm
- Continuously adjustable and self-supporting
- Pullout- and dirt-safe
- Rod hot-dip galvanized
- PE-casing and PE-centering cap with gasket
- Polygon-bush from galvanized steel
- PE-sleeve, fitted for all dimensions
- Torque max.140Nm

d-d (mm)	Pipe cover (mm)	Code	Weight (kg)	L (m)
125 - 225	0.75-1.10	173 103 075	2.100	0.60 - 0.96
125 - 225	1.10-1.80	173 103 076	3.108	0.95 - 1.60
125 - 225	1.65-2.75	173 103 077	7.200	1.40 - 2.50



Extension spindle for ball valve Telescopic

- For ELGEF Plus ball valve d20-d110mm
- Extension spindle acc. to DVGW GW336
- Steel square connection 20x20mm for d20-75
- Steel square connection 25x25mm for d90-d110
- Continuously adjustable and self-supporting
- Pullout- and dirt-safe
- Rod hot-dip galvanized
- PE-casing and PE-centering cap with gasket
- Inclusive clip-pin out of stainless steel
- Torque max.140Nm

d-d (mm)	Pipe cover (mm)	Code	L (m)
20 - 75	0.75-1.10	173 103 175	0.54 - 0.93
20 - 75	1.10-1.70	173 103 176	0.87 - 1.55
20 - 75	1.60-2.50	173 103 177	1.32 - 2.39
90 - 110	0.75-1.10	173 103 185	0.55 - 0.85
90 - 110	1.10-1.70	173 103 186	0.80 - 1.38
90 - 110	1.60-2.50	173 103 187	1.30 - 2.33



Extension spindle for tapping valves rigid

- PE-casing with anti-sand cap
- PE-sleeve, suitable for tapping valve
- Square bar steel, hot-dip galvanized
- Clip-pin from stainless steel 1.4301
- Bush CI40 with slot and clip-pin (tool-free connection)

Pipe cover (m)	Code	Weight (kg)	L (m)
0.75	160 050 620	0.897	0.43
1.00	160 050 621	1.544	0.74
1.25	160 050 622	1.944	0.99
1.50	160 050 623	2.246	1.18

Extension spindle for tapping valve telescopic

- Continuously adjustable and self-supporting
- Pullout- and dirt-safe
- Rod hot-dip galvanized
- PE-casing and PE-centering cap with gasket
- Clip-pin from stainless steel 1.4301
- Bush CI40 with slot and clip-pin (tool-free connection)
- PE-sleeve, suitable for tapping valve

Pipe cover (m)	Code	Weight (kg)	L (m)
0.75-1.00	160 050 520	1.475	0.45 - 0.70
1.00-1.50	160 050 521	2.356	0.76 - 1.30
1.30-1.90	160 050 522	2.881	0.93 - 1.55
1.70-2.70	160 050 523	2.000	1.30 - 2.35





Stem square cap

- For operation with operating key "C" in accordance with DIN 3223-C
- conical inner square
- Galvanized

L (mm)	Code	Weight (kg)
28	173 103 105	0.563

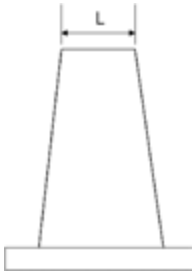

Polygon-adapter

- Polygon connection for Extension spindle ELGEF Plus ball valve d20-d110mm
- Fixation to steel square with grub screws
- Galvanized

d-d (mm)	Code	Weight (kg)
20 - 75	173 103 195	0.493
90 - 110	173 103 196	0.515

Ventilating and Bleed valve Type 591

The 591 valve has a combination of functions. On the one hand the valve allows for a large air discharge whilst filling the pipe and a large air intake whilst draining the pipe. The valve also automatically discharges air while in operation in order to prevent any blockages at points of air culmination.

Automatic function:

The air inside pipelines accumulates at pipe summits. When air bubbles appear in the valve, the float inside the valve will drop which allows the air to be released. When the water rises again, the float is automatically lifted and the valve closes.

Kinetic function:

When emptying a pipeline, the float will drop completely. This allows for a large air volume intake through the large orifice. When filling the pipeline, the water flow inside the pipe will force the air out through the orifice.



Calculation basis for the right valve

Dimensioning

The working pressure range should be defined so that the maximum operating pressure lies within this range, otherwise the valve will not open. The appropriate type and size of ventilating and bleed valve should be selected so that the respective air volume can be conducted off under working pressure.

Opening conditions type 595

DN (mm)	10	15	20	25	32	40	50	65	80	100
Required vacuum to lift the cone (bar)	0.028	0.028	0.030	0.030	0.035	0.040	0.050	0.060	0.060	0.060

Density of the medium

To ensure that the cone has optimal lift, the specific weights of the cone materials should be noted in relation to the density of the medium.

Cone material

Cone material	Density
PP-H	0.91 g/cm ³
ABS	1.03 g/cm ³
PP-TV (talc)	1.05 g/cm ³
PVC-U	1.38 g/cm ³
PVC-C	1.50 g/cm ³
PVDF	1.78 g/cm ³

Calculations for valve configuration

To select the correct valve size, the max. flow (Q in m³/h) is first calculated.

To do this, the flow velocity of the medium (vr) is required, as is the inner diameter of the medium-conveying pipe (di).

$$Q = Vr * \frac{\pi}{4} * di^2 * 0.001 * 3.6$$

The volume flow of the medium can be equated with the gas volume to be discharged or filled.

If several aerating or deaerating valves are used, each valve must be configured for the maximum flow velocity. With the calculated volume flow, the correct valve dimension can be determined from the air volume diagram. The velocity in this diagram corresponds to the discharge velocity of the gases at the valve. It is recommended that, if possible, 20m/s is not exceeded to prevent excessive wear on the valve.

Air volume diagram

For smooth operation and a long service life, bleeders should not be overdimensioned. If the flow rate is too high for the predetermined nominal diameter of the connector, the problem can be remedied by increasing the working pressure range with correspondingly lower flow rate.

For more information, please see the Georg Fischer Planning Fundamentals, which serves as a detailed reference work in selecting a valve, or consult our website.



Air volume diagram

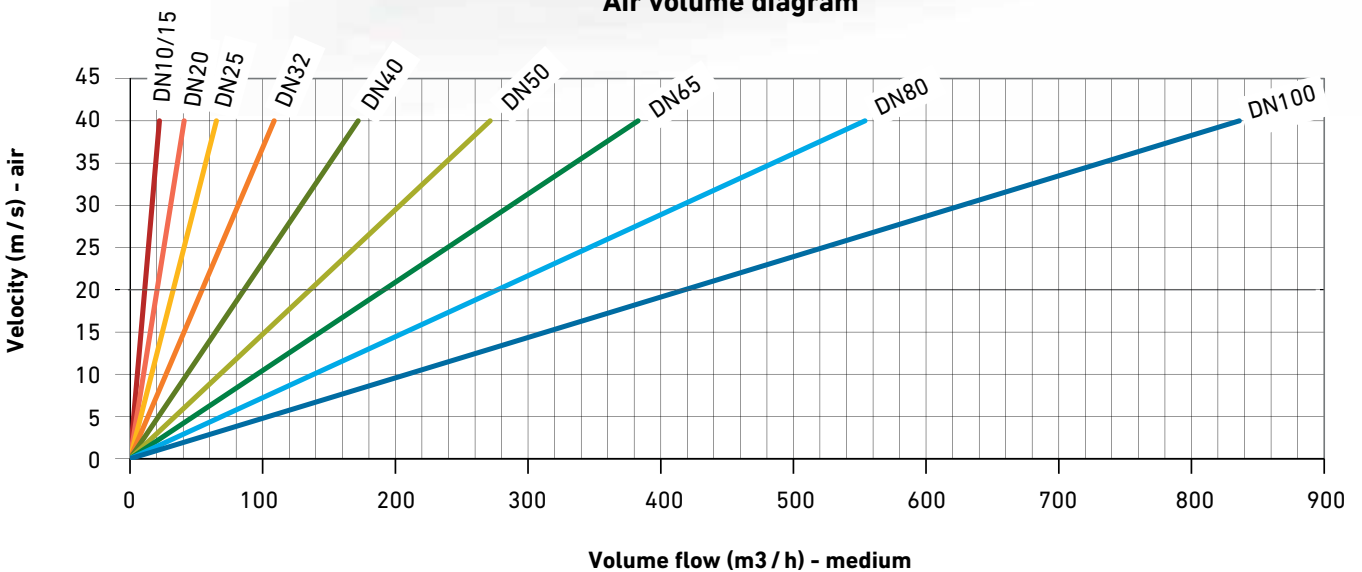

— A speed of more than 20 m/s is not recommended. We suggest about 10 to 15 m/s as optimal speed range.

Type 591



ecoFIT
Ventilating and bleed valve Type 591
With butt fusion spigots long
PE100 SDR11 metric

Model:

- Material: PVC-U/PE
- With protection cap up to DN50 made of PP-GF, DN65-100 made of POM
- Floater made of PP-H
- Designed for easy installation and removal
- Compact installation length

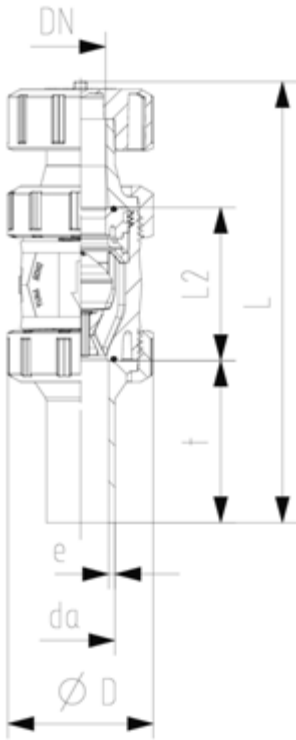

d	DN	PN	EPDM	FPM	D	L	L2	t	e	closest inch
(mm)	(mm)	(bar)	Code	Code	(mm)	(mm)	(mm)	(mm)	(mm)	(inch)
20	15	16	161 591 121	161 591 130	50	175	56	69	2.25	1/2
25	20	16	161 591 122	161 591 131	58	195	65	76	2.30	3/4
32	25	16	161 591 123	161 591 132	68	207	71	76	2.90	1
40	32	16	161 591 124	161 591 133	84	230	85	82	3.70	1 1/4
50	40	16	161 591 125	161 591 134	97	254	89	91	4.60	1 1/2
63	50	16	161 591 126	161 591 135	124	298	101	110	5.80	2
75	65	16	161 591 127	161 591 136	166	334	136	125	6.80	2 1/2
90	80	16	161 591 128	161 591 137	200	360	141	140	8.20	3
110	100	16	161 591 129	161 591 138	238	411	164	160	10.00	4



Ventilating and bleed valve
Type 591 PVC-U
With BSP brass thread

Model:

- With protection cap up to DN50 made of PP-GF, DN65-100 made of POM
- Floater made of PP-H
- Designed for easy installation and removal
- Compact installation length

d	DN	PN	EPDM	FPM	di	D	L	t	R
(mm)	(mm)	(bar)	Code	Code	(mm)	(mm)	(mm)	(mm)	(inch)
16	10	16	161 591 139	161 591 149	10	50	135	13.0	¾
20	15	16	161 591 140	161 591 150	13	50	140	14.0	½
25	20	16	161 591 141	161 591 151	16	58	156	16.5	¾
32	25	16	161 591 142	161 591 152	20	68	172	19.0	1
40	32	16	161 591 143	161 591 153	26	84	195	21.5	1 ¼
50	40	16	161 591 144	161 591 154	33	97	216	22.5	1 ½
63	50	16	161 591 145	161 591 155	40	124	252	27.0	2
75	65	16	161 591 146	161 591 156	58	166	292	38.2	2 ½
90	80	16	161 591 147	161 591 157	70	200	311	41.3	3
110	100	16	161 591 148	161 591 158	95	238	354	47.3	4

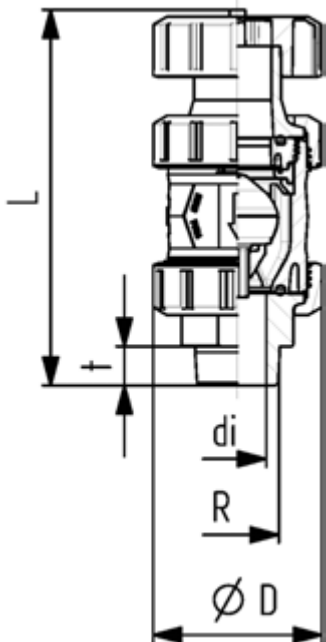

Electromagnetic flow sensor meter

The conveyance and conversion of raw water to potable water is expensive and demanding. Therefore, investments in modern, reliable and completely selfsufficient control systems are decisive for economic viability. The medium being measured flows through the generated magnetic field. The induced tension is measured by the electrode arrangement, which is proportional to the flow speed of the medium passing through the system.

Dimensions: from DN 50 to DN2550
Flow Volume: from 0.05m/s to 10m/s
Accuracy: +/- 2%
Current supply: 24VDC
Signal output: compatible with Signet 5075, 5500, 5600, 8550 & 8900. Also SPS, Datalogger
Working temperature: -15oC to 85oC
Connection: 1 ¼ inch, 1 ½ inch, hot tap installation

Parts in contact with medium: stainless steel 1.4404, PVDF, EPM

Areas of use:

- Communal water distribution
- Potable water reservoirs
- Water treatment
- Water transmission station
- Waste water



Solutions for all kinds of Material



Electrofusion Saddle

Thanks to our modular system, our saddles offer Possibilities from 63mm up to 400mm.



POLY 16 PLUS

This mechanical saddle can be used on all plastic sytems. The dimension spectrum spans from 20mm to 315mm.



Multi/Saddle

The perfect solution for all pipe materials excluding PE. The Multi/Saddle is available from 60mm to 355mm and can be used in non-pressure and under pressure integration of the magmeter.



Multi Clamp/Saddle

These saddles are made from stainless steel and are available in dimensions from 68mm to 501mm. This solution can also integrate the magmeter under pressure or in non-pressure situations.



Tapping tool W400

The modular tapping tool for all pipe materials. Light, strong and easy to use. For drill holes from ½ inch to 2 inches.

Type 2552



Type 2552 Magmeter Current output (4 to 20 mA)

Flow:

- Installs into pipe sizes: 2 to 102 in, DN50 to DN2550
- Operating range: 0.05 to 10 m/s, 0.15 to 33 ft/s
- Max Pressure rating: PP 10.3 bar @ 25 °C, 150 psi @ 77 °F
- Power source: 4 to 20mA: 21.6 to 26.4 VDC, 22.1mA max

MFR #	Mounting	Connection	Code
3-2552-21-A-12	9.4 in. depth	1 1/4 in. NPT	159 001 514
3-2552-21-B-12	9.4 in. depth	1 1/4 in. NPT	159 001 516
3-2552-22-A-12	9.4 in. depth	1 1/4 in. ISO	159 001 518
3-2552-22-B-12	9.4 in. depth	1 1/4 in. ISO	159 001 520
3-2552-33-A-12	14.8 in. depth	1 1/2 in. NPT	159 001 525
3-2552-33-B-12	14.8 in. depth	1 1/2 in. NPT	159 001 527
3-2552-34-A-12	14.8 in. depth	1 1/2 in. ISO	159 001 526
3-2552-34-B-12	14.8 in. depth	1 1/2 in. ISO	159 001 528



Type 2552 Magmeter Frequency or Digital (S³L) output

Flow:

- Installs into pipe sizes: 2 to 102 in, DN50 to DN2550
- Operating range: 0.05 to 10 m/s, 0.15 to 33 ft/s
- Max Pressure rating: PP 10.3 bar @ 25 °C, 150 psi @ 77 °F
- Power source: 5 to 26.4 VDC, 15mA max
- Compatibility: 8900, 9900, 9900-1BC, 9950

MFR #	Mounting	Connection	Code
3-2552-21-A-11	9.4 in. depth	1 1/4 in. NPT	159 001 513
3-2552-21-B-11	9.4 in. depth	1 1/4 in. NPT	159 001 515
3-2552-22-A-11	9.4 in. depth	1 1/4 in. ISO	159 001 517
3-2552-22-B-11	9.4 in. depth	1 1/4 in. ISO	159 001 519
3-2552-33-A-11	14.8 in. depth	1 1/2 in. NPT	159 001 521
3-2552-33-B-11	14.8 in. depth	1 1/2 in. NPT	159 001 523
3-2552-34-A-11	14.8 in. depth	1 1/2 in. ISO	159 001 522
3-2552-34-B-11	14.8 in. depth	1 1/2 in. ISO	159 001 524

Type 2551



Type 2551 Magmeter; Display Version with relays Frequency or Digital (S³L) output

Flow:

- Installs into pipe sizes: DN15 to DN900, 0.5 to 36 in
- Operating range: 0.05 to 10 m/s, 0.15 to 33 ft/s
- Max Pressure rating: PP 10.3 bar @ 25 °C, 150 psi @ 77 °F
- Power Source: Frequency: 5 to 24 VDC, 15 mA max. Digital (S³L): 5 to 6.5 VDC, 15 mA max.
- Compatibility: 8900, 9900, 9900-1BC, 9950
- *Only Signet installation fittings

MFR #	Body	Electrode	Pipe Size (inch)	Sensor Type	Code
3-2551-P0-21	PP	316L SS	0.5 - 4.0	-X0	159 001 267
3-2551-P1-21	PP	316L SS	5.0 - 8.0	-X1	159 001 268
3-2551-P2-21	PP	316L SS	10.0 - 36.0	-X2	159 001 435
3-2551-T0-21	PVDF	Titanium	0.5 - 4.0	-X0	159 001 436
3-2551-T1-21	PVDF	Titanium	5.0 - 8.0	-X1	159 001 437

table continued on the next page

MFR #	Body	Electrode	Pipe Size (inch)	Sensor Type	Code
3-2551-T2-21	PVDF	Titanium	10.0 - 36.0	-X2	159 001 454
3-2551-V0-21	PVDF	Hastelloy C	0.5 - 4.0	-X0	159 001 269
3-2551-V1-21	PVDF	Hastelloy C	5.0 - 8.0	-X1	159 001 270
3-2551-V2-21	PVDF	Hastelloy C	10.0 - 36.0	-X2	159 001 456



ecoFIT installation fitting type 312 electrofusion system

Model:

- Material: PE
- Threaded outlet 1 ¼" NPSM

Range of use:

- Compatible Signet pH/ORP sensors: type 2724, 2725, 2726, 2734, 2736, 2735
- Compatible Signet flow sensors: type 2551, 2537, 515, 8510, 2536, 8512

Attention:

- sensor length depends on installation fitting

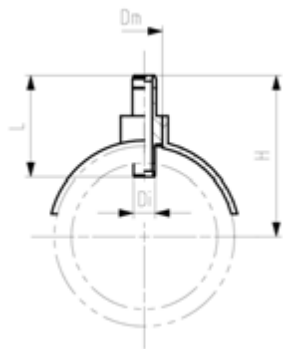

d (mm)	EPDM Code	Weight (kg)	PN (bar)	H (mm)	Di (mm)	L (mm)	Dm (mm)	Sensor Type
75	753 312 012	1.000	16	122.60	37.5	101.6	63	flow x1
90	753 312 013	1.000	16	129.80	37.5	101.6	63	flow x1
110	753 312 014	1.000	16	142.00	37.5	101.6	63	flow x1
125	753 312 015	1.000	16	141.10	37.5	101.6	63	flow x1
140	753 312 016	1.000	16	145.90	37.5	101.6	63	flow x1
160	753 312 017	1.000	16	153.00	37.5	101.6	63	flow x1
180	753 312 018	1.000	16	253.20	37.5	177.8	63	flow x2
200	753 312 019	1.000	16	244.00	37.5	177.8	63	flow x2
225	753 312 020	1.000	16	249.80	37.5	177.8	63	flow x2
250	753 312 021	1.000	16	257.80	37.5	177.8	63	flow x2
280	753 312 022	1.000	16	267.80	37.5	177.8	63	flow x2
315	753 312 023	1.000	16	278.50	37.5	177.8	63	flow x2
355	753 312 024	1.000	16	292.64	37.5	177.8	63	flow x2
400	753 312 025	1.000	16	307.20	37.5	177.8	63	flow x2

Ultrasonic flow



Type U1000 Compact Clamp-on Flow Sensor Display Version, 4-20 mA and Pulse Output

- Principle: non-contact ultrasonic transit time
- Measuring range: 0.1...10 m/s
- Pipe size [d]: 25...115 mm
- Pipe materials: Plastics and steel
- Output: 4-20 mA, 4-wire, Pulse
- Integrated display and programming buttons
- Supply power: 12...24 V AC/DC

MFR #	Measuring range (m ³ /h)	Code
U1000-1	0.1 - 10 m/s	159 300 085



Portaflow 330/220 "clamp-on" portable flowmeter

Model:

- Includes transducer guide rail and all mounting hardware
- Carrying case, cables, manual and other ancillary equipment
- Portaflow 330 comes with build in data logger

d-d (mm)	330 A+B Code	Weight (kg)	220 A Code	Weight (kg)	220 B Code	Weight (kg)
13 - 2000	159 300 001	7.000				
13 - 114			159 300 002	6.000		
50 - 1000					159 300 003	6.000



Ultraflow U3000 Ultrasonic Flowsensor

- Principle: non-contact ultrasonic transit time
- Measuring range: 0.1...20m/s
- Pipe size [d]: 13...2000mm
- Pipe materials: Plastics and steel
- Output: 4-20mA, 4-wire; Pulse
- Integrated display and programming buttons
- Supply power: 12...24V AC/DC, 110/230V AC
- Includes transducer guide rail and all mounting hardware

MFR #	Voltage	d-d (mm)	Code	Weight (kg)
U3000A	230V AC	13 - 114	159 300 004	4.888
U3000B	230V AC	115 - 299	159 300 006	4.000
U3000B	230V AC	300 - 2000	159 300 075	5.000
U3000A	24V DC	13 - 114	159 300 005	4.000
U3000B	24V DC	115 - 299	159 300 007	4.000
U3000B	24V DC	300 - 2000	159 300 077	5.000



Ultraflow U4000 Ultrasonic Flowsensor with built in data logger

- Principle: non-contact ultrasonic transit time
- Measuring range: 0.1...20m/s
- Pipe size [d]: 13...2000mm
- Pipe materials: Plastics and steel
- Output: 4-20mA, 4-wire; Pulse; RS-232; USB
- Integrated display and programming buttons
- Supply power: 12...24V AC/DC, 110/230V AC
- Includes transducer guide rail and all mounting hardware
- Built in data logger

MFR #	Voltage	d-d (mm)	Code	Weight (kg)
U4000A	230V AC	13 - 114	159 300 008	4.000
U4000A	230V AC	115 - 299	159 300 010	4.000
U4000B	230V AC	300 - 2000	159 300 076	5.000
U4000A	24V DC	13 - 114	159 300 009	4.000
U4000B	24V DC	115 - 299	159 300 011	4.000
U4000B	24V DC	300 - 2000	159 300 079	4.800



Ultraflow 3000/4000 Ultrasonic flow transmitter

Model:

- Includes transducer guide rail and all mounting hardware
- Enclosure rating IP65
- Ultraflo 4000 comes with a build in data logger

For type B please state with your order: - Kable lenght: 5 or 10 meter - Liquid temperature °C: -
Liquid type: - Pipe size (d): - Pipe wall thickness (mm):

d-d (mm)	Voltage	3000 A Code	3000 B Code	4000 A Code	4000 B Code	Weight (kg)
13 - 115	230V AC	159 300 004	159 300 006	159 300 008	159 300 010	4.000
50 - 2000	24V DC	159 300 005	159 300 007	159 300 009	159 300 011	4.000



Ultrasonic thickness gauge

Code	Weight (kg)
159 300 012	1.000

Utility Product Ranges

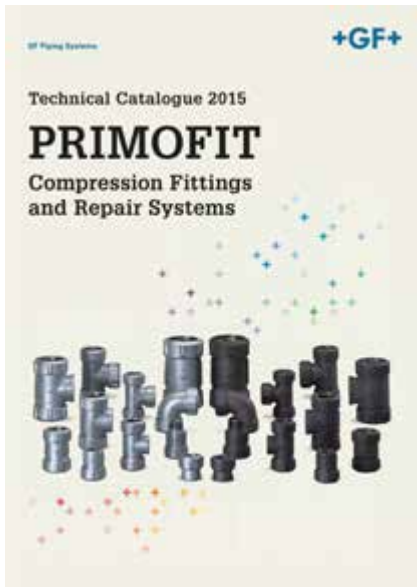

Technical Catalogue Utility 2015



Omicron Product Range Machines & Tools 2017

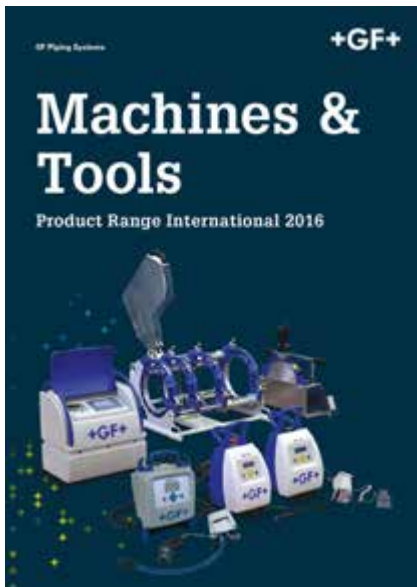

SC International Product Range Machines & Tools 2016



Product Catalogue WAGA

Further Product Ranges you will find at:

http://www.gfps.com/int/en/support_and_services/downloads/water-gas-utilities.html

ecoFIT

All you need in PE

Polyethylene welded system
for industrial applications



ecoFIT system

System specification



* Standards:



	PE100	PE80
Material		
Color	RAL 9005	RAL 9005
Density	~ 0.95 g/cm ³ (EN ISO 1183 / ASTM D 792)	~ 0.93 g/cm ³ (EN ISO 1183 / ASTM D 792)
Thermal expansion coefficient	0.15–0.20 mm/m K (DIN 53752)	0.15–0.20 mm/m K (DIN 53752)
Thermal conductivity at 23 °C	0.38 W/m K (EN 12664)	0.43 W/m K (EN 12664)
Thermal expansion	0.16–0.18 mm/m K	0.16–0.18 mm/m K
Yield stress at 23 °C	25 N/mm ² (EN ISO 527)	18 N/mm ² (EN ISO 527)
Tensile E-modul at 23 °C	900 N/mm ² (EN ISO 527)	700 N/mm ² (EN ISO 527)
Charpy notched impact strength at 23 °C	83 kJ/m ² (EN ISO 179)	110 kJ/m ² (EN ISO 179)
Charpy notched impact strength at -40 °C	13 kJ/m ² (EN ISO 179)	7 kJ/m ² (EN ISO 179)
Limiting Oxygen Index (LOI)	17.4 % (ISO 4589)	17.4 % (ISO 4589)
Dimensions	d20–d630 in accordance to EN ISO 15494	d20–d110 in accordance to EN ISO 15494
Surface condition	accordance to EN ISO 15494	accordance to EN ISO 15494
Material and product approvals	<ul style="list-style-type: none"> - DIBt (Deutsches Institut für Bautechnik) - FM Approvals (Factory Mutual) - IIP (Istituto Italiano dei Plastici) - GL (Germanischer Lloyd) - LR (Lloyd's Regist. of Shipping) - RINA (Registro Italiano Navale) - DNV (Det Norske Veritas) - CCS (China Classific. Society) - ABS (American Bureau of Shipping) - NK (Nippon Kaiji Kyokai) - RMROS (Russian Maritime Register of Shipping) 	<ul style="list-style-type: none"> - DIBt (Deutsches Institut für Bautechnik)
Packaging	Fittings and valves are bagged	Fittings and valves are bagged
Marking and labeling	All components are embossed with a permanent identification during the production process to ensure full traceability: <ul style="list-style-type: none"> <li style="width: 50%;">- Brand name <li style="width: 50%;">- Lot No. <li style="width: 50%;">- Material <li style="width: 50%;">- Product description <li style="width: 50%;">- Dimensions <li style="width: 50%;">- Article number <li style="width: 50%;">- Pressure rating <li style="width: 50%;">- Standard and approvals 	

* Approvals / Acceptance:



* An overview of all standards and approvals is stated online: www.gfps.com

Industry Range

ecoFIT Pipes	106
ecoFIT Socket Welding System	109
ecoFIT Butt Welding System	115
Valves with PE ends	137

ecoFIT Pipes

PE100 pipes

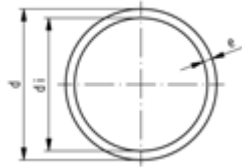

ecoFIT pressure pipe SDR 17,6 PN10

Model:

- Material: PE100
- Dimension: DIN 8074/75
- Colour: RAL 9011 graphite black
- Pipe length: 6m, plain ends

d (mm)	PN (bar)	Code	Weight (kg/m)	e (mm)
25	10	193 017 307	0.139	1.8
32	10	193 017 308	0.181	1.8
40	10	193 017 309	0.288	2.3
50	10	193 017 310	0.445	2.9
63	10	193 017 311	0.695	3.6
75	10	193 017 312	0.987	4.3
90	10	193 017 313	1.400	5.1
110	10	193 017 314	2.100	6.3
125	10	193 017 315	2.690	7.1
140	10	193 017 316	3.370	8.0
160	10	193 017 317	4.400	9.1
180	10	193 017 318	5.540	10.2
200	10	193 017 319	6.860	11.4
225	10	193 017 320	8.640	12.8
250	10	193 017 321	10.700	14.2
280	10	193 017 322	13.300	15.9
315	10	193 017 323	16.900	17.9

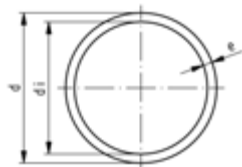

ecoFIT pressure pipe SDR 11 PN16

Model:

- Material: PE100
- Dimension: DIN 8074/75
- Colour: RAL 9011 graphite black
- Pipe length: 6m, plain ends

d (mm)	PN (bar)	Code	Weight (kg/m)	e (mm)
16	16	193 017 355	0.084	1.8
20	16	193 017 356	0.113	1.9
25	16	193 017 357	0.173	2.3
32	16	193 017 358	0.274	2.9
40	16	193 017 359	0.434	3.7
50	16	193 017 360	0.673	4.6
63	16	193 017 361	1.060	5.8
75	16	193 017 362	1.480	6.8
90	16	193 017 363	2.140	8.2
110	16	193 017 364	3.180	10.0
125	16	193 017 365	4.120	11.4
140	16	193 017 366	5.130	12.7
160	16	193 017 367	6.740	14.6
180	16	193 017 368	8.510	16.4
200	16	193 017 369	10.500	18.2
225	16	193 017 370	13.300	20.5
250	16	193 017 371	16.300	22.7
280	16	193 017 372	20.500	25.4
315	16	193 017 373	25.900	28.6

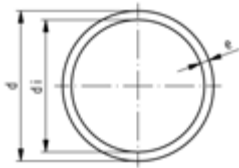

ecoFIT pipe SDR11

Model:

- Material: PE100
- Colour: RAL 9011 graphite black
- Dimension: DIN 8074
- Pipe length: 5m, with plain ends

* In these two sizes, stiffeners Code No. 733 900 006 (20 x 1,9) and 733 900 007 (25 x 2.3) must be used with socket fusion joints.

	d (mm)	PN (bar)	Code	Weight (kg/m)	e (mm)	di (mm)
	16	16	193 017 155	0.084	1.8	12.4
*	20	16	193 017 156	0.113	1.9	16.2
*	25	16	193 017 157	0.173	2.3	20.4
	32	16	193 017 158	0.274	2.9	26.2
	40	16	193 017 159	0.434	3.7	32.6
	50	16	193 017 160	0.673	4.6	40.8
	63	16	193 017 161	1.060	5.8	51.4
	75	16	193 017 162	1.480	6.8	61.4
	90	16	193 017 163	2.140	8.2	73.6
	110	16	193 017 164	3.180	10.0	90.0
	125	16	193 017 165	4.120	11.4	102.8
	140	16	193 017 166	5.130	12.7	114.6
	160	16	193 017 167	6.740	14.6	130.8
	180	16	193 017 168	8.510	16.4	147.2
	200	16	193 017 169	10.500	18.2	163.6
	225	16	193 017 170	13.300	20.5	184.0
	250	16	193 017 171	16.300	22.7	204.6
	280	16	193 017 172	20.500	25.4	229.2
	315	16	193 017 173	25.900	28.6	257.8
	355	16	193 017 174	32.900	32.2	290.6
	400	16	193 017 175	41.700	36.3	327.4
	450	16	193 017 176	52.800	40.9	368.2
	500	16	193 017 177	65.200	45.4	409.2

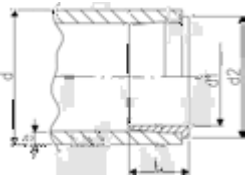

ecoFIT stiffener

Model:

- Material: PE100
- Used as support during d20 and d25 socket fusion jointing to prevent the pipe from collapsing during the heating and jointing process.

d (mm)	Code	Weight (kg/m)	L (mm)	e (mm)	d1 (mm)	D2 (mm)	d2 (mm)
20	733 900 006	0.001	10	1.9	14	18	18
25	733 900 007	0.001	11	2.3	18	22	23

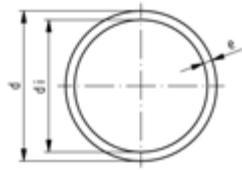

ecoFIT pipe SDR17.6

Model:

- Material: PE100
- Colour: RAL 9011 graphite black
- Dimension: DIN 8074
- Pipe length: 5m, with plain ends

d (mm)	PN (bar)	Code	Weight (kg/m)	e (mm)	di (mm)
25	10	193 017 107	0.139	1.8	21.4
32	10	193 017 108	0.181	1.8	28.4
40	10	193 017 109	0.288	2.3	35.4
50	10	193 017 110	0.445	2.9	44.2
63	10	193 017 111	0.695	3.6	55.8
75	10	193 017 112	0.987	4.3	66.4
90	10	193 017 113	1.400	5.1	79.8
110	10	193 017 114	2.100	6.3	97.4
125	10	193 017 115	2.690	7.1	110.8
140	10	193 017 116	3.370	8.0	124.0
160	10	193 017 117	4.400	9.1	141.8
180	10	193 017 118	5.540	10.2	159.6
200	10	193 017 119	6.860	11.4	177.2
225	10	193 017 120	8.640	12.8	199.4
250	10	193 017 121	10.700	14.2	221.6
280	10	193 017 122	13.300	15.9	248.2
315	10	193 017 123	16.900	17.9	279.2
355	10	193 017 124	21.400	20.1	314.8
400	10	193 017 125	27.200	22.7	354.6
450	10	193 017 126	34.300	25.5	400.0
500	10	193 017 127	42.500	28.4	443.2

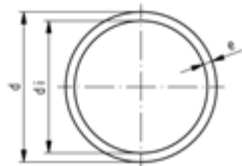

ecoFIT pipe SDR7.4

Model:

- Material: PE100
- Dimension: DIN 8074
- Colour: RAL 9011 graphite black
- Length: 5 m
- for socket fusion without stiffeners
- Not suitable for butt fusion

d (mm)	Code	Weight (kg/m)	e (mm)	di (mm)
10	193 017 203	0.048	1.8	6.4
12	193 017 204	0.060	1.8	8.4
16	193 017 205	0.100	2.2	11.6
20	193 017 206	0.156	2.8	14.4
25	193 017 207	0.243	3.5	18.0

ecoFIT Socket Welding System

Socket fusion fittings

ecoFIT elbow 90°

Model:

- Material: PE80

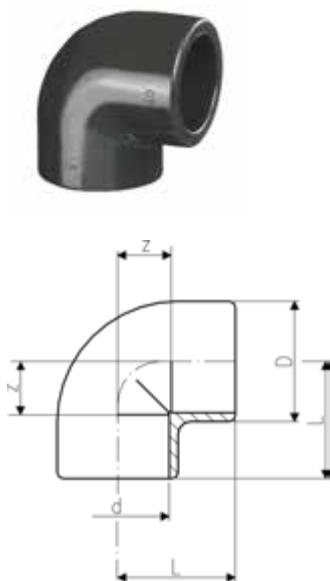

d (mm)	PN (bar)	Code	Weight (kg)	D (mm)	L (mm)	z (mm)
20	10	733 100 106	0.022	31	28	14
25	10	733 100 107	0.031	36	32	16
32	10	733 100 108	0.048	44	38	20
40	10	733 100 109	0.078	54	44	24
50	10	733 100 110	0.129	66	51	28
63	10	733 100 111	0.228	82	62	35
75	10	733 100 112	0.311	93	76	45
90	10	733 100 113	0.498	110	88	53
110	10	733 100 114	0.864	134	106	65

ecoFIT elbow 45°

Model:

- Material: PE80



d (mm)	PN (bar)	Code	Weight (kg)	D (mm)	L (mm)	z (mm)
20	10	733 150 106	0.018	31	21	7
25	10	733 150 107	0.026	36	24	8
32	10	733 150 108	0.043	44	28	10
40	10	733 150 109	0.061	53	33	13
50	10	733 150 110	0.087	64	36	13
63	10	733 150 111	0.184	82	43	16
75	10	733 150 112	0.229	93	51	20
90	10	733 150 113	0.357	114	58	23
110	10	733 150 114	0.653	134	68	27

ecoFIT tee 90° equal

Model:

- Material: PE80



d (mm)	PN (bar)	Code	Weight (kg)	D (mm)	L (mm)	z (mm)
20	10	733 200 106	0.028	31	28	14
25	10	733 200 107	0.041	36	32	16
32	10	733 200 108	0.060	44	38	20
40	10	733 200 109	0.100	54	44	24
50	10	733 200 110	0.166	66	51	28
63	10	733 200 111	0.298	82	62	35
75	10	733 200 112	0.409	93	76	45
90	10	733 200 113	0.749	114	88	53
110	10	733 200 114	1.112	134	106	65

ecoFIT socket equal

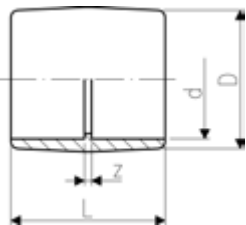

Model:

- Material: PE80

d (mm)	PN (bar)	Code	Weight (kg)	D (mm)	L (mm)	z (mm)
20	10	733 910 106	0.014	31	35	7
25	10	733 910 107	0.018	36	39	7
32	10	733 910 108	0.027	44	43	7
40	10	733 910 109	0.043	54	48	8
50	10	733 910 110	0.074	66	54	8
63	10	733 910 111	0.124	82	62	8
75	10	733 910 112	0.152	93	70	8
90	10	733 910 113	0.234	112	81	11
110	10	733 910 114	0.419	134	96	14

ecoFIT reducer

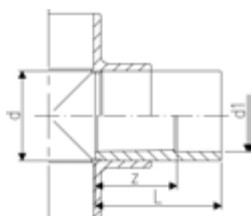
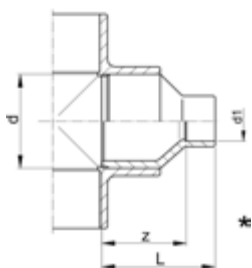

Model:

- Material: PE80
- With socket fusion spigot and fusion socket metric

d (mm)	d1 (mm)	PN (bar)	Code	Weight (kg)	L (mm)	z (mm)
25	20	10	733 910 337	0.013	39	23
32	25	10	733 910 341	0.021	43	27
*	40	20	733 910 348	0.023	48	34
*	40	25	733 910 347	0.027	48	32
	40	32	733 910 346	0.032	48	30
*	50	32	733 910 353	0.042	54	36
	50	40	733 910 352	0.049	54	34
*	63	20	733 910 362	0.057	64	50
*	63	25	733 910 361	0.060	64	48
*	63	32	733 910 360	0.064	64	46
*	63	40	733 910 359	0.070	64	44
	63	50	733 910 358	0.086	64	41
	75	63	733 910 364	0.103	62	35
*	90	63	733 910 371	0.180	88	62
	90	75	733 910 370	0.144	70	39
	110	90	733 910 376	0.254	81	45

ecoFIT end cap



Model:

- Material: PE80

d (mm)	PN (bar)	Code	Weight (kg)	D (mm)	L (mm)
20	10	733 960 106	0.010	30	27
25	10	733 960 107	0.016	36	30
32	10	733 960 108	0.025	44	34
40	10	733 960 109	0.038	53	38
50	10	733 960 110	0.061	65	44
63	10	733 960 111	0.097	80	51
75	10	733 960 112	0.150	91	66
90	10	733 960 113	0.274	111	77
110	10	733 960 114	0.405	137	93

ecoFIT unions for socket fusion

ecoFIT adapter union metric



Model:

- Material: PE80
- Union End: Fusion socket, PE80 metric
- Union bush: brass with fusion socket insert, PE80 metric
- Union Nut: brass
- Gasket: O-ring NBR (Nitrile-rubber)

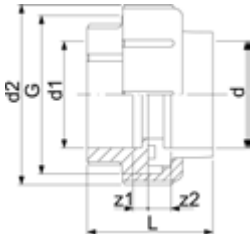

d (mm)	d1 (mm)	PN (bar)	Code	Weight (kg)	G (inch)	L (mm)	z1 (mm)	D2 (mm)	d2 (mm)	z2 (mm)
20	20	10	733 580 106	0.163	1 1/4	46	6	46	46	3
25	25	10	733 580 107	0.214	1 1/2	49	6	52	52	3
32	32	10	733 580 108	0.294	2	51	6	64	64	3
40	40	10	733 580 109	0.473	2 1/2	56	8	79	79	3
50	50	10	733 580 110	0.491	2 2/3	61	8	85	85	3
63	63	10	733 580 111	0.730	3 1/2	69	8	104	104	3

ecoFIT adaptor union metric Rp



Model:

- Material: PE80/brass
- Union End: Fusion socket, PE80 metric
- Union bush: nickel-plated, parallel female thread Rp
- Union Nut: brass
- Gasket: O-ring NBR (Nitrile-rubber)

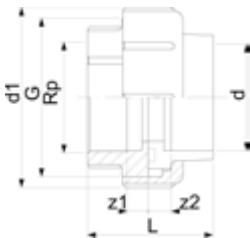

d (mm)	Rp (inch)	PN (bar)	Code	Weight (kg)	G (inch)	L (mm)	d1 (mm)	z1 (mm)	z2 (mm)
20	1/2	10	733 580 206	0.209	1 1/4	46	46	6	10
25	3/4	10	733 580 207	0.269	1 1/2	48	52	6	9
32	1	10	733 580 208	0.376	2	51	64	6	8
40	1 1/4	10	733 580 209	0.596	2 1/2	56	79	8	7
50	1 1/2	10	733 580 210	0.666	2 3/4	59	85	8	7
63	2	10	733 580 211	0.960	3 1/2	65	104	8	5

ecoFIT adaptor union metric R



Model:

- Material: PE80/brass
- Union End: Fusion socket, PE80 metric
- Union bush: nickel-plated, taper male thread R
- Union Nut: brass
- Gasket: O-ring NBR (Nitrile-rubber)

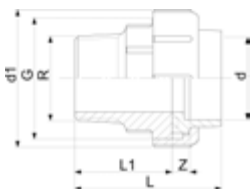

d (mm)	R (inch)	PN (bar)	Code	Weight (kg)	d1 (mm)	G (inch)	L (mm)	L1 (mm)	z (mm)
20	1/2	10	733 580 706	0.260	46	1 1/4	62	40	6
25	3/4	10	733 580 707	0.324	52	1 1/2	65	41	6
32	1	10	733 580 708	0.470	64	2	71	45	6
40	1 1/4	10	733 580 709	0.754	79	2 1/2	78	48	8
50	1 1/2	10	733 580 710	0.781	85	2 3/4	81	43	8
63	2	10	733 580 711	1.166	104	3 1/2	91	54	8



ecoFIT union end

Model:

- Material: PE80
- With fusion socket metric
- Suitable for unions, tank connectors and diaphragm valves Type 514

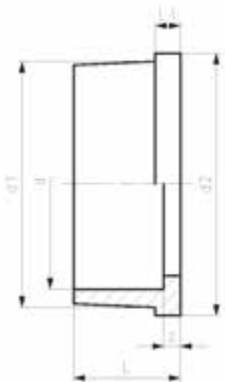

d (mm)	PN (bar)	Code	Weight (kg)	d1 (mm)	d2 (mm)	L (mm)	L1 (mm)	z (mm)
20	10	734 600 106	0.006	28	30	19	5	5
25	10	734 600 107	0.013	36	39	21	5	5
32	10	734 600 108	0.015	42	45	23	6	5
40	10	734 600 109	0.026	53	57	25	6	5
50	10	734 600 110	0.027	59	63	28	7	5
63	10	734 600 111	0.044	74	79	32	8	5



O-Ring gasket

Model:

- For flange adaptors
- Hardness approx. 65° Shore

d (mm)	DN (mm)	EPDM Code	Weight (kg)	FPM Code	Weight (kg)	D (mm)	D1 (mm)	D2 (mm)	closest inch (inch)
16	10	748 410 000	0.002	749 410 000	0.005	26	19	3.53	3/8
20	15	748 410 001	0.002	749 410 001	0.002	31	23	3.53	1/2
25	20	748 410 007	0.002	749 410 007	0.002	35	28	3.53	3/4
32	25	748 410 002	0.003	749 410 002	0.003	43	36	3.53	1
40	32	748 410 003	0.004	749 410 003	0.002	55	44	5.34	1 1/4
50	40	748 410 012	0.004	749 410 012	0.008	64	53	5.34	1 1/2
63	50	748 410 013	0.006	749 410 013	0.011	80	69	5.34	2
75	65	748 410 014	0.007	749 410 014	0.012	93	82	5.34	2 1/2
90	80	748 410 015	0.008	749 410 015	0.015	112	101	5.34	3
110	100	748 410 016	0.016	749 410 016	0.031	134	120	6.99	4
315	300			749 410 174	0.083	356	342	6.99	12

ecoFIT adaptor fittings for socket fusion

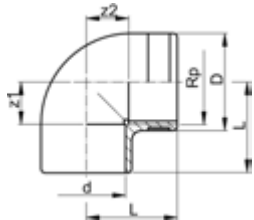

ecoFIT elbow 90° metric Rp

Model:

- Material: PE80
- With fusion socket metric and parallel female thread Rp, reinforced
- Reinforcing ring stainless (A2)
- Connection to plastic or metal threads
- Do not use thread sealing pastes that are harmful to PE
- Install with low mechanical stress and avoid large cyclic temperature changes

d (mm)	Rp (inch)	PN (bar)	Code	Weight (kg)	D (mm)	L (mm)	z1 (mm)	z2 (mm)
20	½	10	733 100 206	0.024	30	28	14	14
25	¾	10	733 100 207	0.033	35	32	16	16
32	1	10	733 100 208	0.061	44	38	20	20
40	1 ¼	10	733 100 209	0.094	54	44	24	24

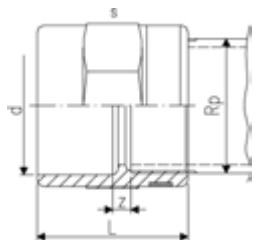

ecoFIT adaptor socket metric Rp

Model:

- Material: PE80
- Reinforcing ring stainless (A2)
- Connection to plastic or metal threads
- With fusion socket metric and parallel female thread Rp, reinforced
- Do not use thread sealing pastes that are harmful to PE
- Install with low mechanical stress and avoid large cyclic temperature changes

d (mm)	Rp (inch)	PN (bar)	Code	Weight (kg)	L (mm)	s (mm)	z (mm)
20	½	10	733 910 206	0.020	35	32	7
25	¾	10	733 910 207	0.026	39	36	7
32	1	10	733 910 208	0.042	45	46	7
40	1 ¼	10	733 910 209	0.068	53	55	7
50	1 ½	10	733 910 210	0.098	54	65	9
63	2	10	733 910 211	0.155	62	80	9

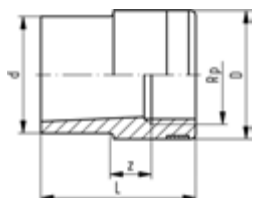

ecoFIT reducing bush metric Rp

Model:

- Material: PE80
- Reinforcing ring stainless (A2)
- Connection to plastic or metal threads
- Do not use thread sealing pastes that are harmful to PE
- Install with low mechanical stress and avoid large cyclic temperature changes
- With fusion spigot metric and BSP parallel female thread, reinforced

d (mm)	Rp (inch)	PN (bar)	Code	Weight (kg)	L (mm)	z (mm)
20	¾	10	733 910 434	0.012	33	7
25	½	10	733 910 437	0.015	37	6
32	¾	10	733 910 441	0.028	43	8
40	1	10	733 910 446	0.046	49	9
50	1 ¼	10	733 910 452	0.071	55	10

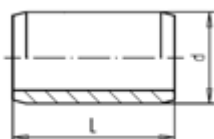

ecoFIT barrel nipple metric

Model:

- Material: PE100
- With fusion spigots on both sides
- For the shortest possible distance between fittings

* In these two sizes, stiffeners Code No. 733 900 006 (20 x 1,9) and 733 900 007 (25 x 2.3) must be used with socket fusion joints.

	d (mm)	PN (bar)	Code	Weight (kg)	L (mm)
*	20	10	753 910 906	0.005	40
*	25	10	753 910 907	0.006	40
	32	10	753 910 908	0.010	50
	40	10	753 910 909	0.017	50
	50	10	753 910 910	0.029	60
	63	10	753 910 911	0.058	70
	75	10	753 910 912	0.095	74
	90	10	753 910 913	0.163	89
	110	10	753 910 914	0.305	110

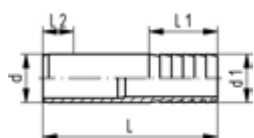

ecoFIT hose connector metric

Model:

- Material: PE100
- With socket fusion spigot metric and parallel hose connection

d	d1	PN	Code	Weight	L	L1	L2
(mm)	(mm)	(bar)		(kg)	(mm)	(mm)	(mm)
20	20	10	753 960 406	0.006	55	27	14
25	25	10	753 960 407	0.015	68	36	16
32	32	10	753 960 408	0.024	77	36	18
40	40	10	753 960 409	0.035	80	42	20
50	50	10	753 960 410	0.056	90	48	23
63	60	10	753 960 411	0.093	100	50	27

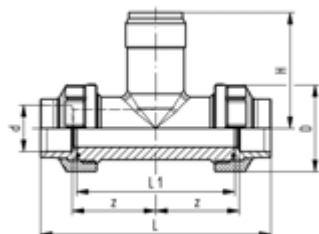

ecoFIT installation fitting type 310 For socket systems metric

Range of use:

- Compatible Signet flow sensors: type 2551, 2537, 515, 8510, 2536, 8512
- Compatible Signet pH/ORP sensors: type 2724, 2725, 2726, 2734, 2736, 2735

Attention:

- sensor length depends on installation fitting

Model:

- Material: PP-H/PE80
- Threaded outlet 1 1/4" NPSM
- Union end with fusion socket PE80
- Body and union nut PP-H

d	DN	EPDM Code	Weight	FPM Code	D	z	L	L1	H	Sensor Type
(mm)	(mm)		(kg)		(mm)	(mm)	(mm)	(mm)	(mm)	
20	15	733 310 006	0.136	733 310 036	48	50	128	90	76	flow X0, pH XX
25	20	733 310 007	0.190	733 310 037	58	55	421	100	78	flow X0, pH XX
32	25	733 310 008	0.250	733 310 038	65	60	156	110	81	flow X0, pH XX
40	32	733 310 009	0.356	733 310 039	79	60	160	110	85	flow X0, pH XX
50	40	733 310 010	0.510	733 310 040	91	65	176	120	89	flow X0, pH XX
63	50	733 310 011	0.800	733 310 041	105	70	194	130	95	flow X0, pH XX

ecoFIT Butt Welding System

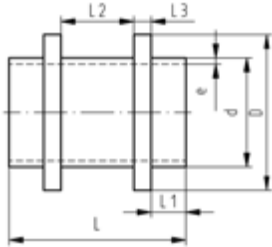
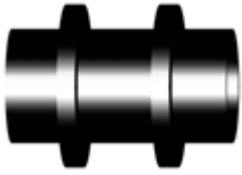

ecoFIT fixpoint fitting SDR11

Model:

- Material: PE100
- Conventional butt-welding according to DVS 2207
- Machined
- IR = Infrared-(IR Plus) compatible. Choose fusion parameters: PE100

d	FM	Code	Weight	D	L	L1	L2	L3	e
(mm)			(kg)	(mm)	(mm)	(mm)	(mm)	(mm)	(mm)
63	IR	753 665 558	0.182	90	122	30	42	10	5.8
75	IR	753 665 559	0.265	110	122	30	42	10	6.8
90	IR	753 665 560	0.357	125	122	30	42	10	8.2
110	IR	753 665 561	0.610	140	142	30	52	15	10.0
125	IR	753 665 562	0.811	160	152	35	52	15	11.4
140	IR	753 665 563	1.068	180	162	40	52	15	12.7
160	IR	753 665 564	1.349	200	162	40	52	15	14.6
180	IR	753 665 565	2.001	225	182	45	52	20	16.4
200	IR	753 665 566	2.469	250	182	45	52	20	18.2
225	IR	753 665 567	3.438	280	192	45	52	25	20.5
250		753 665 568	3.858	280	212	50	62	25	22.7
280		753 665 569	5.217	315	222	50	62	30	25.4
315		753 665 570	6.627	355	222	50	62	30	28.6
355		753 665 571	7.731	400	192	30	62	35	32.2
400		753 665 572	10.890	450	212	30	72	40	36.3
450		753 665 573	14.775	500	232	35	72	45	40.9
500		753 665 574	20.268	560	252	40	72	50	45.4
560		753 665 575	28.608	630	282	45	82	55	50.8
630		753 665 576	39.129	710	302	50	82	60	57.2

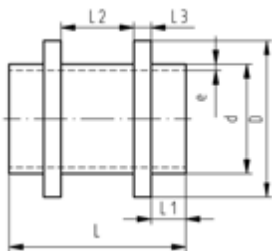
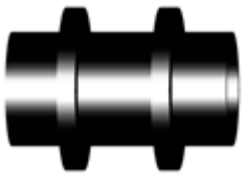

ecoFIT fixpoint fitting SDR17/17.6

Model:

- Material: PE100
- Conventional butt-welding according to DVS 2207
- IR = Infrared-(IR Plus) compatible. Choose fusion parameters: PE100
- Machined

d	FM	Code	Weight	D	L	L1	L2	L3	e
(mm)			(kg)	(mm)	(mm)	(mm)	(mm)	(mm)	(mm)
63	IR	753 665 577	0.144	90	122	30	42	10	3.8
75	IR	753 665 578	0.212	110	122	30	42	10	4.5
90	IR	753 665 579	0.279	125	122	30	42	10	5.4
110	IR	753 665 580	0.457	140	142	30	52	15	6.6
125	IR	753 665 581	0.618	160	152	35	52	15	7.4
140	IR	753 665 582	0.815	180	162	40	52	15	8.3
160	IR	753 665 583	1.014	200	162	40	52	15	9.5
180	IR	753 665 584	1.528	225	182	45	52	20	10.7
200	IR	753 665 585	1.887	250	182	45	52	20	11.9
225	IR	753 665 586	2.661	280	192	45	52	25	13.4
250		753 665 587	2.796	280	212	50	62	25	14.8
280		753 665 588	3.829	315	222	50	62	30	16.6
315		753 665 589	4.871	355	222	50	62	30	18.7
355		753 665 590	5.812	400	192	30	62	35	21.1
400		753 665 591	8.180	450	212	30	72	40	23.7
450		753 665 592	11.015	500	232	35	72	45	26.7
500		753 665 593	15.251	560	252	40	72	50	29.7
560		753 665 594	21.557	630	282	45	82	55	33.2
630		753 665 595	29.574	710	302	50	82	60	37.4

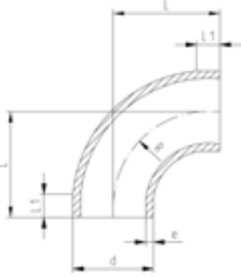

ecoFIT bend 90° SDR11

Model:

- Material: PE100
- Conventional butt-welding according to DVS 2207
- IR = Infrared-(IR Plus) compatible. Choose fusion parameters: PE100

d (mm)	FM	Code	Weight (kg)	L (mm)	L1 (mm)	R (mm)	e (mm)
20	IR	753 018 706	0.007	38	23	15	1.9
25	IR	753 018 707	0.013	42	23	19	2.3
32	IR	753 018 708	0.025	46	22	24	2.9
40	IR	753 018 709	0.041	51	21	30	3.7
50	IR	753 018 710	0.065	58	21	37	4.6
63	IR	753 018 711	0.124	66	21	45	5.8
75	IR	753 018 712	0.246	100	20	90	6.8
90	IR	753 018 713	0.355	100	20	90	8.2
110	IR	753 018 714	0.757	141	25	130	10.0
125	IR	753 018 715	0.818	125	28	116	11.4
140	IR	753 018 716	1.148	140	33	116	12.7
160	IR	753 018 717	1.699	160	33	151	14.6
180	IR	753 018 718	2.394	180	33	171	16.4
200	IR	753 018 719	3.264	200	33	190	18.2
225	IR	753 018 720	4.535	220	33	210	20.5
250		753 018 621	6.713	256	48	232	22.7
280		753 018 622	9.885	282	48	262	25.4
315		753 018 623	14.158	321	48	297	28.6
355		753 021 024	17.200	380	38	355	32.3
400		753 021 025	31.100	434	41	400	36.3
450		753 021 026	38.300	445	49	400	40.9
500		753 021 027	47.300	445	49	400	45.4

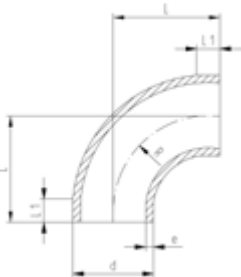

ecoFIT bend 90° SDR17/17.6

Model:

- Material: PE100
- Conventional butt-welding according to DVS 2207
- IR = Infrared-(IR Plus) compatible. Choose fusion parameters: PE100

d (mm)	FM	Code	Weight (kg)	L (mm)	L1 (mm)	R (mm)	e (mm)
50	IR	753 018 635	0.052	58	21	37	2.9
63	IR	753 018 636	0.087	66	21	45	3.6
75	IR	753 018 737	0.176	100	20	90	4.3
90	IR	753 018 738	0.245	100	20	90	5.1
110	IR	753 018 739	0.513	141	20	130	6.3
125	IR	753 018 515	0.556	125	28	116	7.3
140	IR	753 018 516	0.785	140	33	131	8.2
160	IR	753 018 517	1.156	160	33	151	9.4
180	IR	753 018 518	1.619	180	33	171	10.6
200	IR	753 018 519	2.208	200	33	190	11.7
225	IR	753 018 520	3.039	220	33	210	12.9
250		753 018 521	4.645	256	48	232	14.2
280		753 018 522	7.020	280	48	262	15.9
315		753 018 523	10.099	321	48	297	17.9
355		753 020 824	11.300	340	38	355	21.1
400		753 020 825	15.700	345	41	400	23.7
450		753 020 826	25.868	445	49	400	26.7
500		753 020 827	35.000	445	49	400	29.7



ecoFIT elbow 90° SDR11

Model:

- Material: PE100
- Conventional butt-welding according to DVS 2207
- IR = Infrared-(IR Plus) compatible. Choose fusion parameters: PE100

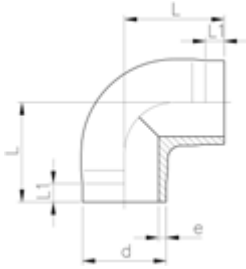

d (mm)	FM	Code	Weight (kg)	L (mm)	L1 (mm)	e (mm)
20	IR	753 108 606	0.009	38	25	1.9
25	IR	753 108 607	0.013	42	26	2.3
32	IR	753 108 608	0.026	46	27	2.9
40	IR	753 108 609	0.047	51	22	3.7
50	IR	753 108 610	0.086	58	23	4.6
63	IR	753 108 611	0.150	66	21	5.8



ecoFIT elbow 45° SDR11

Model:

- Material: PE100
- Conventional butt-welding according to DVS 2207
- IR = Infrared-(IR Plus) compatible. Choose fusion parameters: PE100

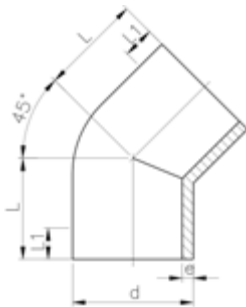

d (mm)	FM	Code	Weight (kg)	L (mm)	L1 (mm)	e (mm)
20	IR	753 158 606	0.007	32	24	1.9
25	IR	753 158 607	0.013	34	25	2.3
32	IR	753 158 608	0.019	36	25	2.9
40	IR	753 158 609	0.036	39	25	3.7
50	IR	753 158 610	0.059	42	26	4.6
63	IR	753 158 611	0.103	47	29	5.8
75	IR	753 158 612	0.146	49	29	6.8
90	IR	753 158 613	0.241	57	34	8.2
110	IR	753 158 614	0.442	70	43	10.0
125	IR	753 158 615	0.638	79	48	11.4
140	IR	753 158 616	0.902	88	55	12.7
160	IR	753 158 617	1.340	100	60	14.6
200	IR	753 158 619	2.612	124	75	18.2
225	IR	753 158 620	3.638	140	85	20.5



ecoFIT elbow 45° SDR17.6

Model:

- Material: PE100
- Conventional butt-welding according to DVS 2207
- IR = Infrared-(IR Plus) compatible. Choose fusion parameters: PE100

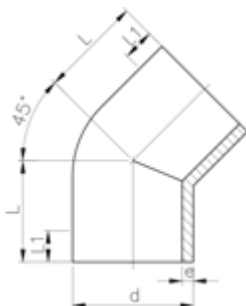

d (mm)	FM	Code	Weight (kg)	L (mm)	L1 (mm)	e (mm)
50	IR	753 158 535	0.045	42	26	2.9
63	IR	753 158 536	0.091	47	29	3.6
75	IR	753 158 412	0.125	49	29	4.7
90	IR	753 158 413	0.198	57	34	5.6
110	IR	753 158 414	0.375	70	43	6.9
125	IR	753 158 540	0.542	79	48	7.1
140	IR	753 158 541	0.784	88	55	8.0
160	IR	753 158 542	1.190	100	60	9.1
200	IR	753 158 544	2.331	124	75	11.4
225	IR	753 158 545	3.282	140	85	12.8



ecoFIT tee 90° equal SDR11

Model:

- Material: PE100
- Conventional butt-welding according to DVS 2207
- IR = Infrared-(IR Plus) compatible. Choose fusion parameters: PE100

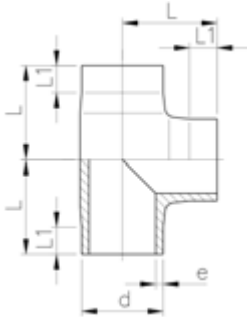

d (mm)	FM	Code	Weight (kg)	L (mm)	L1 (mm)	e (mm)
20	IR	753 208 606	0.013	38	24	1.9
25	IR	753 208 607	0.021	42	26	2.3
32	IR	753 208 608	0.042	46	26	2.9
40	IR	753 208 609	0.065	51	22	3.7
50	IR	753 208 610	0.111	58	22	4.6
63	IR	753 208 611	0.202	66	21	5.8
75	IR	753 208 612	0.312	75	20	6.8
90	IR	753 208 613	0.553	90	20	8.2
110	IR	753 208 614	1.002	110	20	10.0
125	IR	753 208 615	1.509	125	25	11.4
140	IR	753 208 616	2.105	140	28	12.7
160	IR	753 208 617	3.085	160	28	14.6
180	IR	753 208 668	5.062	190	70	16.4
200	IR	753 208 619	5.982	200	35	18.2
225	IR	753 208 620	8.090	220	35	20.5
250		753 208 671	13.326	272	90	22.7
280		753 208 672	20.458	313	108	25.4
315		753 208 673	27.400	348	114	28.6
355		753 208 624	32.600	345	105	32.3
400		753 208 625	42.900	365	105	36.4
450		753 208 626	63.300	425	135	40.9
500		753 208 627	86.000	470	155	45.5



ecoFIT tee 90° reduced SDR11

Model:

- Material: PE100
- Conventional butt-welding according to DVS 2207
- IR = Infrared-(IR Plus) compatible. Choose fusion parameters: PE100

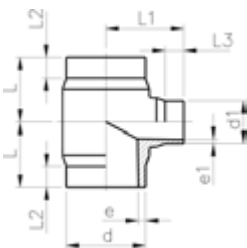

d (mm)	d1 (mm)	FM	Code	Weight (kg)	L (mm)	L1 (mm)	L2 (mm)	L3 (mm)	e (mm)	e1 (mm)
63	32	IR	753 208 351	0.161	65	70	25	25	5.8	2.9
63	50	IR	753 208 352	0.180	65	70	25	25	5.8	4.6
75	32	IR	753 208 353	0.255	70	75	25	25	6.8	2.9
75	50	IR	753 208 354	0.265	70	75	25	25	6.8	4.6
75	63	IR	753 208 355	0.278	70	75	25	25	6.8	5.8
90	50	IR	753 208 357	0.435	80	85	25	25	8.2	4.6
90	63	IR	753 208 358	0.448	80	85	25	25	8.2	5.8
90	75	IR	753 208 359	0.462	80	85	25	25	8.2	6.8
110	32	IR	753 208 360	0.685	90	95	30	25	10.0	2.9
110	50	IR	753 208 361	0.694	90	95	30	25	10.0	4.6
110	63	IR	753 208 362	0.709	90	95	30	25	10.0	5.8
110	75	IR	753 208 363	0.717	90	95	30	25	10.0	6.8
110	90	IR	753 208 364	0.734	90	95	30	25	10.0	8.2
160	63	IR	753 208 371	2.269	142	135	50	30	14.6	5.8
160	75	IR	753 208 372	2.255	142	135	50	30	14.6	6.8
160	90	IR	753 208 373	2.317	142	135	50	30	14.6	8.2
160	110	IR	753 208 374	2.353	142	135	50	30	14.6	10.0
225	90	IR	753 208 388	4.759	155	165	40	30	20.5	8.2
225	110	IR	753 208 389	4.796	155	165	40	30	20.5	10.0
225	160	IR	753 208 391	4.854	155	165	40	30	20.5	14.6
250	110		753 221 031	8.199	228	197	140	37	22.7	10.0
250	160		753 221 032	8.564	229	219	117	60	22.7	14.6



ecoFIT tee 90° reduced SDR17.6

Model:

- Material: PE100
- Conventional butt-welding according to DVS 2207
- IR = Infrared-(IR Plus) compatible. Choose fusion parameters: PE100
- 5 bar Gas / 10 bar Water
- * Branch SDR11

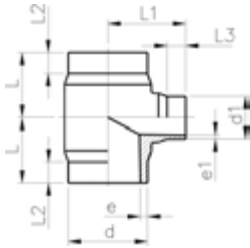

	d	d1	FM	Code	Weight	L	L1	L2	L3	e	e1
	(mm)	(mm)			(kg)	(mm)	(mm)	(mm)	(mm)	(mm)	(mm)
*	63	32	IR	753 208 301	0.163	65	70	25	25	3.6	2.9
	63	50	IR	753 208 302	0.171	65	70	25	25	3.6	2.9
*	75	32	IR	753 208 303	0.231	70	75	25	25	4.3	2.9
	75	50	IR	753 208 304	0.250	70	75	25	25	4.3	2.9
	75	63	IR	753 208 305	0.263	70	75	25	25	4.3	3.6
	90	50	IR	753 208 307	0.411	80	85	25	25	5.1	2.9
	90	63	IR	753 208 308	0.329	80	85	25	25	5.1	3.6
	90	75	IR	753 208 309	0.339	80	85	25	25	5.1	4.3
*	110	32	IR	753 208 310	0.643	90	95	30	25	6.3	2.9
	110	50	IR	753 208 311	0.655	90	95	30	25	6.3	2.9
	110	63	IR	753 208 312	0.516	90	95	30	25	6.3	3.6
	110	75	IR	753 208 313	0.521	90	95	30	25	6.3	4.3
	110	90	IR	753 208 314	0.529	90	95	30	25	6.3	5.1
	160	63	IR	753 208 321	2.103	142	135	50	30	9.1	3.6
	160	75	IR	753 208 322	2.142	142	135	50	30	9.1	4.3
	160	90	IR	753 208 323	1.668	142	135	50	30	9.1	5.1
	160	110	IR	753 208 324	1.687	142	135	50	30	9.1	6.3
	225	90	IR	753 208 338	3.439	155	165	40	30	12.8	5.1
	225	110	IR	753 208 339	3.448	155	165	40	30	12.8	6.3
	225	160	IR	753 208 341	3.471	155	165	40	30	12.8	9.1



ecoFIT tee 90° equal SDR17/17.6

Model:

- Material: PE100
- Conventional butt-welding according to DVS 2207
- IR = Infrared-(IR Plus) compatible. Choose fusion parameters: PE100

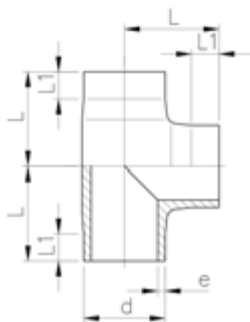

d	FM	Code	Weight	L	L1	e
(mm)			(kg)	(mm)	(mm)	(mm)
50	IR	753 208 535	0.080	59	26	2.9
63	IR	753 208 536	0.187	71	25	3.6
75	IR	753 208 412	0.232	74	20	4.8
90	IR	753 208 413	0.408	90	20	5.6
110	IR	753 208 414	0.724	110	20	6.9
125	IR	753 208 540	1.175	124	27	7.1
140	IR	753 208 541	1.623	141	33	8.0
160	IR	753 208 542	2.431	160	40	9.1
180	IR	753 208 543	3.756	190	70	10.2
200	IR	753 208 544	5.243	210	70	11.4
225	IR	753 208 545	6.030	248	80	12.8
250		753 208 546	9.964	272	90	14.2
280		753 208 547	14.265	313	108	15.9
315		753 208 548	22.284	348	114	17.9
355		753 208 524	21.800	345	105	21.1
400		753 208 525	28.600	365	105	23.7
450		753 208 526	42.400	425	135	26.7
500		753 208 527	57.600	470	155	29.7

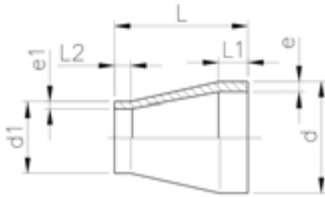

ecoFIT reducer SDR11

Model:

- Material: PE100
- Conventional butt-welding according to DVS 2207
- IR = Infrared-(IR Plus) compatible. Choose fusion parameters: PE100
- Up to d 315 injection moulded, above machined

d	d1	FM	Code	Weight	L	L1	L2	e	e1
(mm)	(mm)			(kg)	(mm)	(mm)	(mm)	(mm)	(mm)
25	20	IR	753 908 637	0.008	50	20	18	2.3	1,9
32	20	IR	753 908 642	0.010	50	20	18	2.9	1,9
32	25	IR	753 908 641	0.006	50	20	18	2.9	2,3
40	20	IR	753 908 648	0.017	58	20	20	3.7	1,9
40	25	IR	753 908 647	0.017	55	20	18	3.7	2,3
40	32	IR	753 908 646	0.019	55	20	18	3.7	2,9
50	25	IR	753 908 654	0.025	60	20	18	4.6	2,3
50	32	IR	753 908 653	0.026	60	20	18	4.6	2,9
50	40	IR	753 908 652	0.032	60	20	18	4.6	3,7
63	32	IR	753 908 660	0.046	65	20	18	5.8	2,9
63	40	IR	753 908 659	0.051	65	20	18	5.8	3,7
63	50	IR	753 908 658	0.056	65	20	18	5.8	4,6
75	40	IR	753 908 666	0.070	68	20	20	6.8	3,7
75	50	IR	753 908 665	0.074	65	20	18	6.8	4,6
75	63	IR	753 908 664	0.081	65	20	18	6.8	5,8
90	63	IR	753 908 671	0.125	75	21	17	8.2	5,8
90	75	IR	753 908 670	0.132	75	22	17	8.2	6,8
110	75	IR	753 908 677	0.219	90	28	17	10.0	6,8
110	90	IR	753 908 676	0.240	90	28	20	10.0	8,2
125	110	IR	753 908 680	0.350	100	32	26	11.4	10,0
140	110	IR	753 908 685	0.437	110	35	28	12.7	10,0
140	125	IR	753 908 684	0.474	110	35	28	12.7	11,4
160	110	IR	753 908 690	0.612	120	40	25	14.6	10,0
160	140	IR	753 908 688	0.674	120	40	33	14.6	12,7
180	90	IR	753 908 877	0.678	157	45	22	16.4	8,2
180	110	IR	753 908 878	0.991	157	45	28	16.4	10,0
180	125	IR	753 908 879	0.528	136	45	32	16.4	11,4
180	140	IR	753 908 880	0.963	136	45	35	16.4	12,7
180	160	IR	753 908 881	1.094	136	45	40	16.4	14,6
200	160	IR	753 908 692	1.247	150	50	35	18.2	14,6
200	180	IR	753 908 883	1.419	151	50	45	18.2	16,4
225	110	IR	753 908 695	1.559	171	55	45	20.5	10,0
225	160	IR	753 908 696	1.643	160	55	37	20.5	14,6
225	180	IR	753 908 885	1.999	171	55	45	20.5	16,4
225	200	IR	753 908 697	1.844	160	55	48	20.5	18,2
250	160		753 908 890	2.416	194	60	40	22.7	14,6
250	180		753 900 001	2.513	175	60	55	22.7	16,4
250	200		753 900 002	2.450	180	60	60	22.7	18,2
250	225		753 908 887	2.766	182	60	55	22.7	20,5
280	200		753 900 004	3.540	205	70	50	25.4	18,2
280	225		753 908 892	1.943	105	30	20	25.4	20,5
280	250		753 908 891	1.802	70	30	18	25.4	22,7
315	200		753 900 007	3.996	225	80	50	28.6	20,5
315	225		753 908 897	3.491	130	30	30	28.6	20,5
315	250		753 908 896	2.379	100	30	20	28.6	22,7
315	280		753 908 895	1.684	63	30	18	28.6	25,4
355	225		753 900 011	4.700	245	90	55	32.3	20,5
355	250		753 900 012	4.400	245	90	60	32.3	22,7
355	280		753 900 013	4.100	245	90	70	32.3	25,4
355	315		753 900 014	3.700	245	90	80	32.3	28,6
400	225		753 900 015	7.963	260	95	60	36.4	20,5
400	250		753 900 016	6.800	260	95	70	36.4	22,7
400	280		753 900 017	6.200	260	95	70	36.4	25,4
400	315		753 900 018	10.829	260	95	80	36.4	28,6
400	355		753 900 019	4.800	260	95	90	36.4	32,3

table continued on the next page

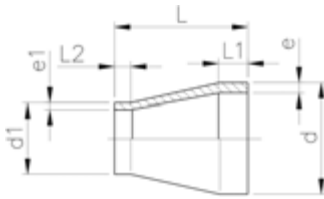

d	d1	FM	Code	Weight	L	L1	L2	e	e1
(mm)	(mm)			(kg)	(mm)	(mm)	(mm)	(mm)	(mm)
450	280		753 900 020	9.000	230	60	70	40.9	25,4
450	315		753 900 021	8.000	230	60	80	40.9	28,6
450	355		753 900 022	7.400	230	60	90	40.9	32,3
450	400		753 900 023	6.600	230	60	95	40.9	36,4
500	315		753 900 024	12.000	230	60	80	45.5	28,6
500	355		753 900 025	10.800	230	60	90	45.5	32,3
500	400		753 900 026	10.000	230	60	95	45.5	36,4
500	450		753 900 027	8.300	200	60	60	45.5	40,9
710	500		753 900 035	24.157	190	84	40	64.5	45,4
710	560		753 900 036	21.770	170	81	40	64.5	50,8
710	630		753 900 037	17.845	140	71	40	64.5	57,2



ecoFIT flush style reducer SDR11

Model:

- Material: PE100
- Flush style design
- Conventional butt-welding according to DVS 2207
- Clamping on welding machine needs to be done always on the bigger diameter (d1)
- The butt fusion machine must be suitable to weld both dimensions (d1 and d2)

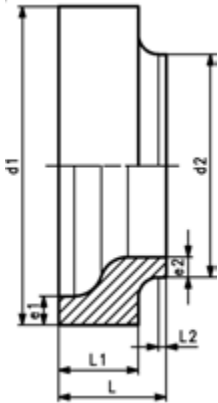

d1	d2	Code	Weight	L	L1	L2	e1	e2
(mm)	(mm)		(kg)	(mm)	(mm)	(mm)	(mm)	(mm)
355	225	753 909 809	5.230	130	95	10.0	32.2	20.5
355	250	753 909 810	3.752	115	80	10.0	32.3	22.7
355	280	753 909 811	4.066	115	80	10.0	32.3	25.4
355	315	753 909 812	4.149	115	80	15.0	32.3	28.6
400	225	753 909 816	7.964	145	110	10.0	36.3	20.5
400	250	753 909 817	6.861	135	100	10.0	36.4	22.7
400	280	753 909 818	6.679	135	100	10.0	36.4	25.4
400	315	753 909 819	6.460	135	100	10.0	36.4	28.6
400	355	753 909 820	6.101	135	100	13.0	36.4	32.3
450	225	753 909 822	11.965	165	125	10.0	40.9	20.5
450	250	753 909 823	11.087	160	120	10.0	40.9	22.7
450	280	753 909 824	9.604	150	100	15.0	40.9	25.4
450	315	753 909 825	9.091	150	100	15.0	40.9	28.6
450	355	753 909 826	8.656	150	100	15.0	40.9	32.3
450	400	753 909 827	8.369	150	100	15.0	40.9	36.4
500	225	753 909 829	16.053	180	130	10.0	45.4	20.5
500	250	753 909 830	15.784	180	130	10.0	45.4	22.7
500	280	753 909 831	14.691	175	125	10.0	45.4	25.4
500	315	753 909 832	10.921	165	115	10.0	45.5	28.6
500	355	753 909 833	11.321	165	115	10.0	45.5	32.3
500	400	753 909 834	12.453	165	115	10.0	45.5	36.4
500	450	753 909 835	12.640	165	115	25.0	45.5	40.9
560	315	753 909 836	22.204	210	160	10.0	50.8	28.6
560	355	753 909 837	19.976	200	150	10.0	50.8	32.2
560	400	753 909 838	17.215	185	135	10.0	50.8	36.3
560	450	753 909 839	14.263	165	115	10.0	50.8	40.9
560	500	753 909 840	13.955	165	115	10.0	50.8	45.4
630	315	753 909 841	29.984	220	170	10.0	57.2	28.6
630	355	753 909 842	29.376	220	170	10.0	57.2	32.2
630	400	753 909 843	26.541	210	160	10.0	57.2	36.3
630	450	753 909 844	23.034	195	145	10.0	57.2	40.9
630	500	753 909 845	19.243	175	125	10.0	57.2	45.4
630	560	753 909 846	17.438	165	115	20.0	57.2	50.8

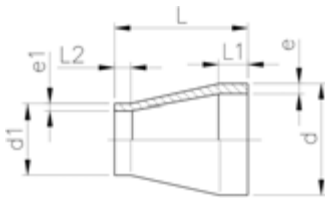

ecoFIT reducer SDR17/17.6

Model:

- Material: PE100
- Conventional butt-welding according to DVS 2207
- IR = Infrared-(IR Plus) compatible. Choose fusion parameters: PE100
- Up to d 315 injection moulded, above machined

d (mm)	d1 (mm)	FM	Code	Weight (kg)	L (mm)	L1 (mm)	L2 (mm)	e (mm)	e1 (mm)
50	40	IR	753 908 926	0.024	55	12	12	2.9	2,3
63	40	IR	753 908 927	0.036	65	16	12	3.6	2,3
63	50	IR	753 908 928	0.039	65	16	12	3.6	2,9
75	40	IR	753 908 904	0.041	71	19	12	4.3	2,3
75	50	IR	753 908 465	0.049	65	20	20	4.3	2,9
75	63	IR	753 908 464	0.056	65	20	20	4.3	3,6
90	63	IR	753 908 471	0.083	75	20	19	5.1	3,6
90	75	IR	753 908 470	0.092	75	20	20	5.1	4,3
110	75	IR	753 908 477	0.157	89	28	18	6.3	4,3
110	90	IR	753 908 476	0.164	90	28	20	6.3	5,1
125	110	IR	753 908 912	0.272	108	32	28	7.1	6,3
140	110	IR	753 908 917	0.330	115	35	28	8.0	6,3
140	125	IR	753 908 916	0.374	115	35	32	8.0	7,1
160	110	IR	753 908 922	0.456	124	40	28	9.1	6,3
160	140	IR	753 908 920	0.499	124	40	35	9.1	8,0
180	90	IR	753 908 975	0.897	157	45	22	10.2	5,1
180	110	IR	753 908 976	0.690	157	45	28	10.2	6,3
180	125	IR	753 908 977	0.616	136	45	32	10.2	7,1
180	140	IR	753 908 978	0.647	136	45	35	10.2	8,0
180	160	IR	753 908 979	0.713	136	45	40	10.2	9,1
200	160	IR	753 908 931	0.860	145	50	40	11.4	9,1
200	180	IR	753 908 981	0.971	151	50	45	11.4	10,2
225	110	IR	753 908 938	1.382	160	55	35	12.8	6,3
225	160	IR	753 908 933	1.120	160	55	40	12.8	9,1
225	180	IR	753 908 985	1.364	171	55	45	12.8	10,2
225	200	IR	753 908 932	1.234	171	55	50	12.8	11,4
250	160		753 908 939	1.601	194	60	40	14.2	9,1
250	180		753 902 801	1.690	175	60	55	14.8	10,7
250	200		753 902 802	1.899	180	60	60	14.8	11,9
250	225		753 908 937	1.853	182	60	55	14.2	12,8
280	200		753 902 804	2.585	205	70	50	16.6	11,9
280	225		753 908 944	1.423	105	30	20	15.9	12,8
280	250		753 908 943	1.002	70	30	18	15.9	14,2
315	200		753 902 807	2.907	225	80	50	18.7	11,9
315	225		753 908 950	2.154	130	30	20	17.9	12,8
315	250		753 908 949	1.702	100	30	20	17.9	14,2
315	280		753 908 999	1.598	63	30	18	17.9	15,9
355	225		753 902 811	4.700	245	90	55	21.1	13,4
355	250		753 902 812	9.425	245	90	60	21.1	14,8
355	280		753 902 813	4.280	245	90	70	21.1	16,6
355	315		753 902 814	3.700	245	90	80	21.1	18,7
400	225		753 902 815	4.600	260	95	60	23.7	13,4
400	250		753 902 816	4.400	260	95	70	23.7	14,8
400	280		753 902 817	5.922	260	95	70	23.7	16,6
400	315		753 902 818	3.520	260	95	80	23.7	18,7
400	355		753 902 819	7.163	260	95	90	23.7	21,1
450	280		753 902 820	6.340	230	60	70	26.7	16,6
450	315		753 902 821	5.400	230	60	80	26.7	18,7
450	355		753 902 822	5.000	230	60	90	26.7	21,1
450	400		753 902 823	8.098	230	60	95	26.7	23,7
500	315		753 902 824	8.100	230	60	80	29.7	18,7
500	355		753 902 825	8.424	230	60	90	29.7	21,1
500	400		753 902 826	7.974	230	60	95	29.7	23,7
500	450		753 902 827	5.500	200	60	60	29.7	26,7
560	400		753 902 828	9.900	230	60	95	33.2	23,7

table continued on the next page

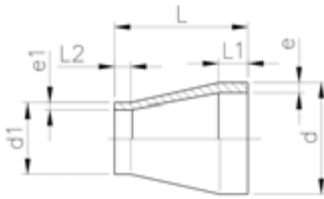

d (mm)	d1 (mm)	FM	Code	Weight (kg)	L (mm)	L1 (mm)	L2 (mm)	e (mm)	e1 (mm)
560	450		753 902 829	8.600	200	60	60	33.2	26.7
560	500		753 902 830	7.600	200	60	60	33.2	29.7
630	400		753 902 831	15.100	230	60	95	37.4	23.7
630	450		753 902 832	13.700	200	60	60	37.4	26.7
630	500		753 902 833	12.000	200	60	60	37.4	29.7
630	560		753 902 834	9.800	200	60	60	37.4	33.2
710	500		753 902 835	16.750	190	84	40	42.1	29.7
710	560		753 902 836	15.014	170	81	40	42.1	33.2
710	630		753 902 837	12.215	140	71	40	42.1	37.4
800	560		753 902 838	22.731	200	85	40	47.4	33.2
800	630		753 902 839	20.475	180	85	40	47.4	37.4
800	710		753 902 840	16.774	150	78	40	47.4	42.1
900	630		753 902 841	32.055	220	96	40	53.3	37.4
900	710		753 902 842	27.731	190	89	40	53.3	42.1
900	800		753 902 843	22.854	160	85	40	53.3	47.4
1000	710		753 902 844	40.412	220	91	40	59.3	42.1
1000	800		753 902 845	33.910	180	86	40	59.3	47.4
1000	900		753 902 846	25.824	140	75	40	59.3	53.3



ecoFIT flush style reducer SDR17/17.6

Model:

- Material: PE100
- Flush style design
- Conventional butt-welding according to DVS 2207
- Clamping on welding machine needs to be done always on the bigger diameter (d1)
- The butt fusion machine must be suitable to weld both dimensions (d1 and d2)

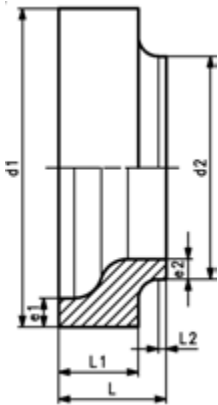

d1 (mm)	d2 (mm)	Code	Weight (kg)	L (mm)	L1 (mm)	L2 (mm)	e1 (mm)	e2 (mm)
355	225	753 909 859	3.922	120	85	10	21.1	13.4
355	250	753 909 860	3.318	115	80	10	21.1	14.8
355	280	753 909 861	3.134	115	80	10	21.1	16.6
355	315	753 909 862	2.716	115	80	15	21.1	18.7
400	225	753 909 866	6.299	135	100	10	23.7	13.4
400	250	753 909 867	5.754	135	100	10	23.7	14.8
400	280	753 909 868	5.468	135	100	10	23.7	16.6
400	315	753 909 869	5.125	135	100	10	23.7	18.7
400	355	753 909 870	4.614	135	100	13	23.7	21.1
450	225	753 909 872	9.323	150	110	10	26.7	13.4
450	250	753 909 873	9.000	150	110	10	27.7	14.8
450	280	753 909 874	8.066	150	110	15	26.7	16.6
450	315	753 909 875	7.354	150	110	15	26.7	18.7
450	355	753 909 876	6.724	150	110	15	26.7	21.1
450	400	753 909 877	6.238	150	110	15	26.7	23.7
500	225	753 909 879	12.120	165	115	10	29.7	13.4
500	250	753 909 880	11.834	165	115	10	29.7	14.8
500	280	753 909 881	11.459	165	115	10	29.7	16.6
500	315	753 909 882	10.502	165	115	10	29.7	18.7
500	355	753 909 883	10.154	165	115	10	29.7	21.1
500	400	753 909 884	8.642	165	115	10	29.7	23.7
500	450	753 909 885	7.978	165	115	25	29.7	26.7
560	315	753 909 886	19.966	210	160	10	33.2	18.7
560	355	753 909 887	17.764	200	150	10	33.2	21.1
560	400	753 909 888	15.168	185	135	10	33.2	23.7
560	450	753 909 889	11.650	165	115	10	33.2	26.7
560	500	753 909 890	10.623	165	115	20	33.2	29.7
630	315	753 909 891	27.625	220	170	10	37.4	18.7
630	355	753 909 892	26.454	220	170	10	37.4	21.1

table continued on the next page

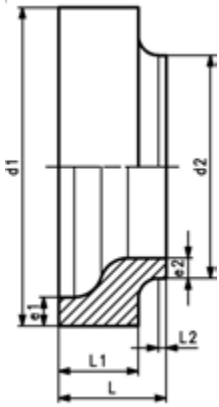

d1 (mm)	d2 (mm)	Code	Weight (kg)	L (mm)	L1 (mm)	L2 (mm)	e1 (mm)	e2 (mm)
630	400	753 909 893	23.648	210	160	10	37.4	23.7
630	450	753 909 894	19.957	195	145	10	37.4	26.7
630	500	753 909 895	15.910	175	125	10	37.4	29.7
630	560	753 909 896	13.272	165	115	20	37.4	33.2

Reducing Bushes excentric, PE100 SDR11



Model:

- Conventional butt fusion according to DVS2207
- Machined

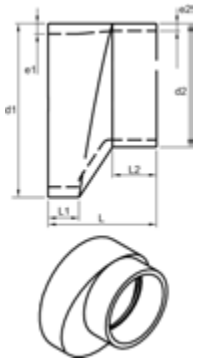

d1 (mm)	d2 (mm)	PN (bar)	Code	L (mm)	L1 (mm)	L2 (mm)	e1 (mm)	e2 (mm)
63	50	16	700 647 600	120	35	35	5,8	4,6
75	50	16	700 647 601	120	40	35	6,8	4,6
75	63	16	700 647 602	120	40	35	6,8	5,8
90	63	16	700 647 603	140	50	50	8,2	5,8
90	75	16	700 647 604	140	50	50	8,2	6,8
110	75	16	700 647 605	140	50	50	10	6,8
110	90	16	700 647 606	140	50	50	10	8,2
125	90	16	700 647 607	140	50	50	11,4	5,1
125	110	16	700 647 608	140	50	50	11,4	10
140	90	16	700 647 609	140	50	50	12,7	8,2
140	110	16	700 647 610	140	50	50	12,7	10
160	90	16	700 647 611	140	50	54	14,6	8,2
160	110	16	700 647 612	120	40	45	14,6	10
160	125	16	700 647 613	110	40	44	14,6	11,4
160	140	16	700 647 614	90	40	33	14,6	12,7
180	125	16	700 647 615	130	40	52	16,4	11,4
180	140	16	700 647 616	110	40	41	16,4	12,7
180	160	16	700 647 617	90	40	33	16,4	16,4
200	140	16	700 647 618	140	40	50	18,2	12,7
200	160	16	700 647 619	120	40	41	18,2	14,6
200	180	16	700 647 620	100	40	43	18,2	16,4
225	160	16	700 647 621	140	40	57	20,5	14,6
225	180	16	700 647 622	120	40	48	20,5	16,4
225	200	16	700 647 623	100	40	40	20,5	18,2
250	180	16	700 647 624	150	40	54	22,7	16,4
250	200	16	700 647 625	130	40	55	22,7	18,2
250	225	16	700 647 626	110	40	40	22,7	20,5
280	200	16	700 647 627	160	40	58	25,4	18,2
280	225	16	700 647 628	130	40	52	25,4	20,5
280	250	16	700 647 629	110	40	47	25,4	22,7
315	225	16	700 647 630	160	40	62	28,6	20,5
315	250	16	700 647 631	140	40	57	28,6	22,7
315	280	16	700 647 632	120	40	54	28,6	25,4
355	250	16	700 647 633	180	40	74	32,2	22,7
355	250	16	700 647 634	150	40	61	32,2	25,4
355	315	16	700 647 635	120	40	51	32,2	28,6
400	280	16	700 647 636	200	40	85	36,3	25,4
400	315	16	700 647 637	170	40	75	36,3	28,6
400	355	16	700 647 638	130	40	58	36,3	32,2
450	315	16	700 647 639	210	40	86	40,9	28,6
450	355	16	700 647 640	180	40	79	40,9	32,2

table continued on the next page

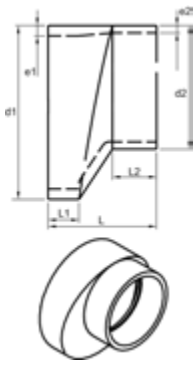

d1 (mm)	d2 (mm)	PN (bar)	Code	L (mm)	L1 (mm)	L2 (mm)	e1 (mm)	e2 (mm)
450	400	16	700 647 641	140	40	65	40,9	36,3
500	315	16	700 647 642	260	40	107	45,4	28,6
500	355	16	700 647 643	220	40	91	45,4	32,2
500	400	16	700 647 644	190	40	86	45,4	36,3
500	450	16	700 647 645	140	40	65	45,4	40,9
560	450	16	700 647 646	200	40	91	50,8	40,9
560	500	16	700 647 647	150	40	70	50,8	45,4
630	500	16	700 647 648	220	40	99	57,2	45,4
630	560	16	700 647 649	170	40	84	57,2	50,8

Reducing Bushes excentric, PE100 SDR17.6

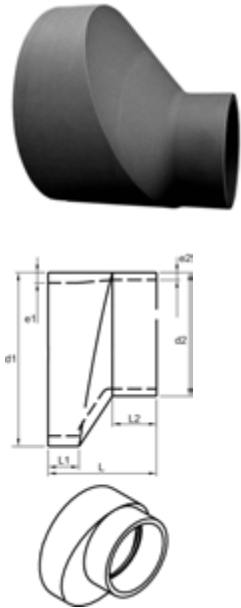

Model:

- Machined
- Conventional butt fusion according to DVS2207

d1 (mm)	d2 (mm)	PN (bar)	Code	L (mm)	L1 (mm)	L2 (mm)	e1 (mm)	e2 (mm)
63	50	10	700 647 650	120	35	35	3,6	2,9
75	50	10	700 647 651	120	40	35	4,3	2,9
75	63	10	700 647 652	120	40	35	4,3	3,6
90	63	10	700 647 653	140	50	50	5,1	3,6
90	75	10	700 647 654	140	50	50	5,1	4,3
110	75	10	700 647 655	140	50	50	6,3	4,3
110	90	10	700 647 656	140	50	50	6,3	5,1
125	90	10	700 647 657	140	50	50	7,1	5,1
125	110	10	700 647 658	140	50	50	7,1	6,3
140	90	10	700 647 659	140	50	50	8,0	5,1
140	110	10	700 647 660	140	50	50	8,0	6,3
160	90	10	700 647 661	140	50	54	9,5	5,4
160	110	10	700 647 662	120	40	45	9,5	6,6
160	125	10	700 647 663	110	40	44	9,5	7,4
160	140	10	700 647 664	90	40	33	9,5	8,3
180	125	10	700 647 665	130	40	52	10,7	7,4
180	140	10	700 647 666	110	40	41	10,7	8,3
180	160	10	700 647 667	90	40	33	10,7	9,5
200	140	10	700 647 668	140	40	50	11,9	8,3
200	160	10	700 647 669	120	40	41	11,9	9,5
200	180	10	700 647 670	100	40	43	11,9	10,7
225	160	10	700 647 671	140	40	57	13,4	9,5
225	180	10	700 647 672	120	40	48	13,4	10,7
225	200	10	700 647 673	100	40	40	13,4	11,9
250	180	10	700 647 674	150	40	54	14,8	10,7
250	200	10	700 647 675	130	40	55	14,8	11,9
250	225	10	700 647 676	110	40	40	14,8	13,4
280	200	10	700 647 677	160	40	58	16,6	11,9
280	225	10	700 647 678	130	40	52	16,6	13,4
280	250	10	700 647 679	110	40	47	16,6	14,8
315	225	10	700 647 680	160	40	62	18,7	13,4
315	250	10	700 647 681	140	40	57	18,7	14,8
315	280	10	700 647 682	120	40	54	18,7	16,6
355	250	10	700 647 683	180	40	74	21,1	14,8
355	280	10	700 647 684	150	40	61	21,1	16,6
355	315	10	700 647 685	120	40	51	21,1	18,7
400	280	10	700 647 686	200	40	85	23,7	16,6
400	315	10	700 647 687	170	40	75	23,7	18,7
400	355	10	700 647 688	130	40	58	23,7	21,1
450	315	10	700 647 689	210	40	86	26,7	18,7
450	355	10	700 647 690	180	40	79	26,7	21,1
450	400	10	700 647 691	140	40	65	26,7	23,7

table continued on the next page

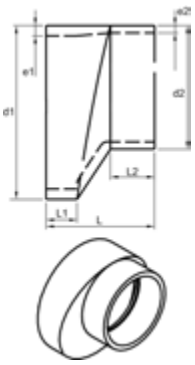

d1 (mm)	d2 (mm)	PN (bar)	Code	L (mm)	L1 (mm)	L2 (mm)	e1 (mm)	e2 (mm)
500	315	10	700 647 692	260	40	107	29,7	18,7
500	355	10	700 647 693	220	40	91	29,7	21,1
500	400	10	700 647 694	190	40	86	29,7	23,7
500	450	10	700 647 695	140	40	65	29,7	26,7
560	450	10	700 647 696	200	40	91	33,2	26,7
560	500	10	700 647 697	150	40	70	33,2	29,7
630	500	10	700 647 698	220	40	99	37,4	29,7
630	560	10	700 647 699	170	40	84	37,4	33,2

End Cap PE100, SDR11

Model:

- Material: PE100
- Conventional butt fusion according to DVS2207
- Machined

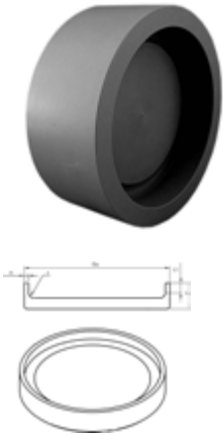

d (mm)	PN (bar)	Code	L1 (mm)	e (mm)	r (mm)	L (mm)
63	16	700 665 184	15	5.8	5	30
75	16	700 665 185	15	6.8	5	30
90	16	700 665 186	15	8.2	5	30
110	16	700 665 187	15	10.0	5	30
125	16	700 665 188	15	11.4	5	35
140	16	700 665 189	15	12.7	5	40
160	16	700 665 190	15	14.6	6	40
180	16	700 665 191	15	16.4	6	45
200	16	700 665 192	15	18.2	6	50
225	16	700 665 193	15	20.5	8	50
250	16	700 665 194	15	22.7	8	55
280	16	700 665 195	15	25.4	8	60
315	16	700 665 196	15	28.6	8	65
355	16	700 665 197	15	32.2	8	70
400	16	700 665 198	15	36.3	10	75
450	16	700 665 199	15	40.9	10	80
500	16	700 665 200	14	45.4	10	90
560	16	700 665 201	14	50.8	10	100
630	16	700 665 202	15	57.2	10	110

End Cap PE100, SDR17.6

Model:

- Material: PE100
- Conventional butt fusion according to DVS2207
- Machined

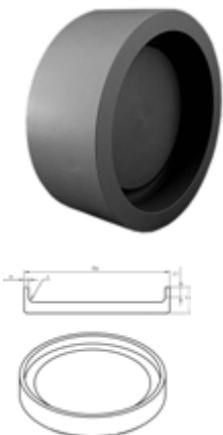

d (mm)	PN (bar)	Code	L (mm)	L1 (mm)	r (mm)	e (mm)
63	10	700 665 260	30	15	5	3.6
75	10	700 665 261	30	15	5	4.3
90	10	700 665 262	30	15	5	5.1
110	10	700 665 263	30	15	5	6.3
125	10	700 665 264	30	15	5	7.1
140	10	700 665 265	30	15	5	8.0
160	10	700 665 266	35	15	6	9.1
180	10	700 665 267	40	15	6	10.2
200	10	700 665 268	40	15	6	11.4
225	10	700 665 269	45	15	8	12.8
250	10	700 665 270	45	15	8	14.2
280	10	700 665 271	45	15	8	15.9

table continued on the next page



d (mm)	PN (bar)	Code	L (mm)	L1 (mm)	r (mm)	e (mm)
315	10	700 665 272	55	15	8	17.9
355	10	700 665 273	55	15	8	20.1
400	10	700 665 274	60	15	10	22.7
450	10	700 665 275	70	15	10	26.7
500	10	700 665 276	75	14	10	29.7
560	10	700 665 277	80	14	10	33.2
630	10	700 665 278	90	15	10	37.4

ecoFIT adaptor fittings for butt fusion

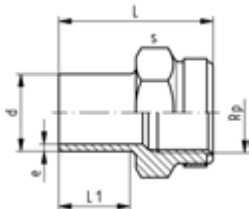

ecoFIT adaptor socket SDR11 metric Rp

Model:

- Material: PE100
- With butt fusion spigot **SDR11** and BSP parallel female thread Rp, reinforced
- Reinforcing ring stainless (A2)
- Connection to plastic or metal threads
- Do not use thread sealing pastes that are harmful to PE
- Install with low mechanical stress and avoid large cyclic temperature changes

d	DN	Rp	FM	Code	Weight	L	L1	s	e
(mm)	(mm)	(inch)			(kg)	(mm)	(mm)	(mm)	(mm)
20	15	½	IR	753 910 266	0.018	49	23	32	1.9
25	20	¾	IR	753 910 267	0.022	51	23	36	2.3
32	25	1	IR	753 910 268	0.038	55	23	46	3.0
40	32	1 ¼	IR	753 910 269	0.068	57	23	55	3.7
50	40	1 ½	IR	753 910 270	0.083	60	23	64	4.6
63	50	2	IR	753 910 271	0.134	62	23	80	5.8

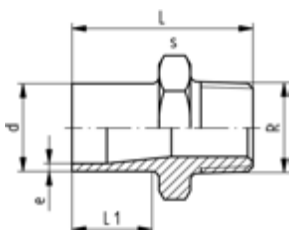

ecoFIT adaptor nipple SDR11 metric R

Model:

- Material: PE100
- With butt fusion spigot SDR11 and tapered male thread
- Do not use thread sealing pastes that are harmful to PE
- Install with low mechanical stress and avoid large cyclic temperature changes

d	R	DN	FM	Code	Weight	L	L1	s	e
(mm)	(inch)	(mm)			(kg)	(mm)	(mm)	(mm)	(mm)
20	½	15	IR	753 910 556	0.013	51	23	32	1.9
25	¾	20	IR	753 910 557	0.026	52	23	36	2.3
32	1	25	IR	753 910 558	0.028	55	23	46	3.0
40	1 ¼	32	IR	753 910 559	0.043	58	23	55	3.7
50	1 ½	40	IR	753 910 560	0.063	60	23	65	4.6
63	2	50	IR	753 910 561	0.104	67	26	80	5.8

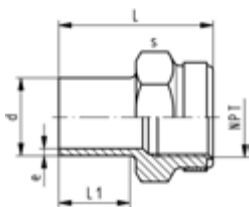

ecoFIT adaptor socket SDR11 metric NPT

Model:

- Material: PE100
- Conventional butt-welding according to DVS 2207
- IR = Infrared-(IR Plus) compatible. Choose fusion parameters: PE100
- NPT tapered female thread to ASTM F 1498
- Reinforcing ring stainless (A2)
- Connection to plastic or metal threads
- Do not use thread sealing pastes that are harmful to PE
- Install with low mechanical stress and avoid large cyclic temperature changes

d	NPT	FM	Code	Weight	L	L1	s	e
(mm)	(inch)			(kg)	(mm)	(mm)	(mm)	(mm)
20	½	IR	753 914 266	0.018	48	23	32	1.9
25	¾	IR	753 914 267	0.022	50	23	36	2.3
32	1	IR	753 914 268	0.038	54	23	46	2.9
40	1 ¼	IR	753 914 269	0.058	56	23	55	3.7
50	1 ½	IR	753 914 270	0.083	60	23	65	4.6
63	2	IR	753 914 271	0.134	62	23	80	5.8

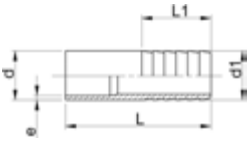

ecoFIT hose connector SDR11 metric

Model:

- Material: PE100
- With butt fusion spigot **SDR11** and parallel hose connection

d (mm)	d1 (mm)	DN (mm)	FM	Code	Weight (kg)	L (mm)	L1 (mm)	e (mm)
20	20	15	IR	753 968 606	0.007	64	27	1.9
25	25	20	IR	753 968 607	0.015	75	36	2.3
32	32	25	IR	753 968 608	0.023	82	36	2.9
40	40	32	IR	753 968 609	0.034	84	42	3.7
50	50	40	IR	753 968 610	0.057	90	48	4.6
63	60	50	IR	753 968 611	0.095	100	50	5.8

ecoFIT installation fittings

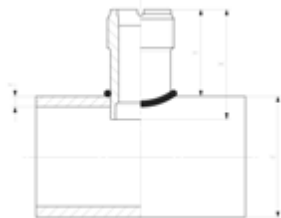
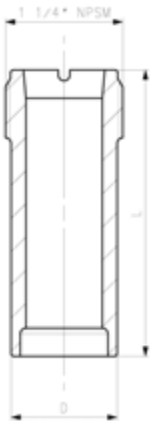

ecoFIT installation fitting type 314

Model:

- Material: PE100
- Threaded outlet 1 1/4" NPSM
- For conventional hot gas back welding according to DVS 2207 part 3

Attention:

- only for pressureless or low pressure application
- pressure rate depends on quality of hot gas back welding
- please consult the instruction manual
- Installation by trained and certified welders only
- sensor length depends on installation fitting

Range of use:

- Compatible Signet flow sensors: type 2551, 2537, 515, 8510, 2536, 8512
- Compatible Signet pH/ORP sensors: type 2724, 2725, 2726, 2734, 2736, 2735

d (mm)	DN	Code	Weight (kg)	D (mm)	L (mm)	Sensor Type
75 - 180	65 - 150	753 314 000	0.040	37	68	flow X0, pH XX
200 - 355	200 - 350	753 314 001	0.057	37	102	flow X1
400 - 630	350 - 600	753 314 002	0.934	37	178	flow X2

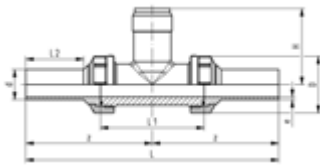

ecoFIT installation fitting type 318 SDR11 For butt fusion systems metric

Attention:

- sensor length depends on installation fitting

Model:

- Material: PE100
- Threaded outlet 1 ¼" NPSM
- Union end with butt fusion spigot PE100
- Body and union nut PP-H

Range of use:

- Compatible Signet pH/ORP sensors: type 2724, 2725, 2726, 2734, 2736, 2735
- Compatible Signet flow sensors: type 2551, 2537, 515, 8510, 2536, 8512

DN (mm)	PN (bar)	FM	d (mm)	EPDM Code	Weight (kg)	FPM Code
15	10	IR	20	753 318 006	0.136	753 318 036
20	10	IR	25	753 318 007	0.190	753 318 037
25	10	IR	32	753 318 008	0.250	753 318 038
32	10	IR	40	753 318 009	0.356	753 318 039
40	10	IR	50	753 318 010	0.510	753 318 040
50	10	IR	63	753 318 011	0.800	753 318 041

D (mm)	z (mm)	L (mm)	L1 (mm)	L2 (mm)	H (mm)	e (mm)	Sensor Type
48	112	224	90	52	76	1.9	flow X0, pH XX
58	121	242	100	53	78	2.3	flow X0, pH XX
65	128	256	110	55	81	2.9	flow X0, pH XX
79	136	272	110	60	85	3.7	flow X0, pH XX
91	147	294	120	66	89	4.6	flow X0, pH XX
105	158	316	130	70	95	5.8	flow X0, pH XX

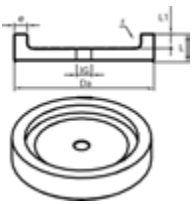

End Cap PE100, SDR17.6 with female thread

Model:

- Material: PE100
- Conventional butt fusion according to DVS2207
- Machined
- metric - Rp
- other thread-dimensions and NPT-thread available on request

d (mm)	Rp (inch)	PN (bar)	Code	r (mm)	L (mm)	L1 (mm)	e (mm)
63	½	10	700 665 279	5	30	15	3.6
75	½	10	700 665 280	5	30	15	4.3
90	½	10	700 665 281	5	30	15	5.1
110	½	10	700 665 282	5	30	15	6.3
125	½	10	700 665 283	5	30	15	7.1
140	½	10	700 665 284	5	30	15	8.0
160	½	10	700 665 285	6	35	15	9.1
180	½	10	700 665 286	6	40	15	10.2
200	½	10	700 665 287	6	40	15	11.4
225	½	10	700 665 288	8	45	15	12.8
250	½	10	700 665 289	8	45	15	14.2
280	½	10	700 665 290	8	45	15	15.9
315	½	10	700 665 291	8	55	15	17.9
355	½	10	700 665 292	8	55	15	20.1
400	½	10	700 665 293	10	60	15	22.7
450	½	10	700 665 294	10	70	15	26.7
500	½	10	700 665 295	10	75	14	29.7
560	½	10	700 665 296	10	80	14	33.2
630	½	10	700 665 297	10	90	15	37.2



End Cap PE100, SDR11 with female thread

Model:

- Material: PE100
- Conventional butt fusion according to DVS2207
- Machined
- metric - Rp
- other thread-dimensions and NPT-thread available on request

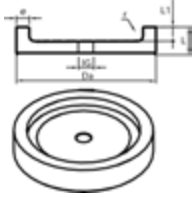

d (mm)	Rp (inch)	PN (bar)	Code	L (mm)	L1 (mm)	e (mm)	r (mm)
63	½	16	700 665 203	30	15	5.8	5
75	½	16	700 665 204	30	15	6.8	5
90	½	16	700 665 205	30	15	8.2	5
110	½	16	700 665 206	30	15	10.0	5
125	½	16	700 665 207	35	15	11.4	5
140	½	16	700 665 208	40	15	12.7	5
160	½	16	700 665 209	40	15	14.6	6
180	½	16	700 665 210	45	15	16.4	6
200	½	16	700 665 211	50	15	18.2	6
225	½	16	700 665 212	50	15	20.5	8
250	½	16	700 665 213	55	15	22.7	8
280	½	16	700 665 214	60	15	25.4	8
315	½	16	700 665 215	65	15	28.6	8
355	½	16	700 665 216	70	15	32.2	8
400	½	16	700 665 217	75	15	36.3	10
450	½	16	700 665 218	80	15	40.9	10
500	½	16	700 665 219	90	14	45.4	10
560	½	16	700 665 220	100	14	50.8	10
630	½	16	700 665 221	110	15	57.2	10



Instrument Installation Fittings PE, SDR17.6 with female thread

Model:

- Material: PE100
- Conventional butt fusion according to DVS2207
- Machined
- metric - Rp
- other thread-dimensions and NPT-thread available on request

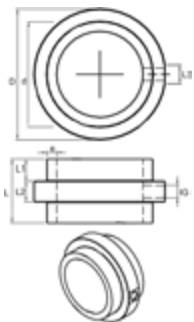

d (mm)	Rp (inch)	PN (bar)	Code	D (mm)	L (mm)	L1 (mm)	L2 (mm)	e (mm)
63	½	10	700 665 462	90	90	30	30	3.6
75	½	10	700 665 463	110	90	30	30	4.3
90	½	10	700 665 464	125	100	30	40	5.1
110	½	10	700 665 465	140	100	30	40	6.3
125	½	10	700 665 466	160	110	35	40	7.1
140	½	10	700 665 467	180	125	40	45	8.0
160	½	10	700 665 468	200	125	40	45	9.1
180	½	10	700 665 469	225	135	45	45	10.2
200	½	10	700 665 470	250	135	45	45	11.4
225	½	10	700 665 471	280	135	45	45	12.8
250	½	10	700 665 472	280	145	50	45	14.2
280	½	10	700 665 473	315	155	50	55	15.9
315	½	10	700 665 474	355	155	50	55	17.9
355	½	10	700 665 475	400	115	30	55	20.1
400	½	10	700 665 476	450	130	30	70	22.7



Instrument Installation Fittings PE, SDR11 with female thread

Model:

- Material: PE100
- Conventional butt fusion according to DVS2207
- Machined
- metric - Rp
- other thread-dimensions and NPT-thread available on request

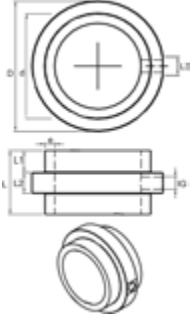

d	Rp	PN	Code	D	L	L1	L2	e
(mm)	(inch)	(bar)		(mm)	(mm)	(mm)	(mm)	(mm)
63	½	16	700 665 425	90	90	30	30	5.8
75	½	16	700 665 426	110	90	30	30	6.8
90	½	16	700 665 427	125	100	30	40	8.2
110	½	16	700 665 428	140	100	30	40	10.0
125	½	16	700 665 429	160	110	35	40	11.4
140	½	16	700 665 430	180	125	40	45	12.7
160	½	16	700 665 431	200	125	40	45	14.6
180	½	16	700 665 432	225	135	45	45	16.4
200	½	16	700 665 433	250	135	45	45	18.2
225	½	16	700 665 434	280	135	45	45	20.5
250	½	16	700 665 435	280	145	50	45	22.7
280	½	16	700 665 436	315	155	50	55	25.4
315	½	16	700 665 437	355	155	50	55	28.6
355	½	16	700 665 438	400	115	30	55	32.2
400	½	16	700 665 439	450	130	30	70	36.3

Unions

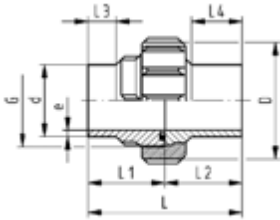

ecoFIT union SDR11

Model:

- Material: PE100
- Conventional butt-welding according to DVS 2207
- IR = Infrared- (IR Plus) compatible.
- Gasket: O-ring EPDM
- **For the dimensions d75-110 please see instructions for the installation**

d (mm)	PN (bar)	FM	EPDM Code	Weight (kg)	FPM Code	Weight (kg)
20	16	IR	753 518 606	0.048	753 528 606	0.042
25	16	IR	753 518 607	0.078	753 528 607	0.052
32	16	IR	753 518 608	0.108	753 528 608	0.083
40	16	IR	753 518 609	0.176	753 528 609	0.151
50	16	IR	753 518 610	0.241	753 528 610	0.196
63	16	IR	753 518 611	0.402	753 528 611	0.406
75	10	IR	753 518 612	0.537	753 528 612	0.520
90	10	IR	753 518 613	0.540	753 528 613	0.562
110	10	IR	753 518 614	0.783	753 528 614	0.760

d (mm)	D (mm)	G (inch)	L (mm)	L1 (mm)	L2 (mm)	L3 (mm)	L4 (mm)	e (mm)
20	48	1	107	54.0	53	26	38	1.9
25	58	1 1/4	113	57.0	56	26	42	2.3
32	65	1 1/2	119	60.0	59	25	41	3.0
40	79	2	126	63.0	63	25	42	3.7
50	91	2 1/4	131	65.0	65	25	44	4.6
63	111	2 3/4	137	69.0	68	25	45	5.8
75	135	S107,5x3,6	132	66.0	66	24	34	6.8
90	135	S107,5x3,6	131	65.5	66	24	45	8.2
110	158	S127,5x3,6	131	65.5	66	25	40	10.0

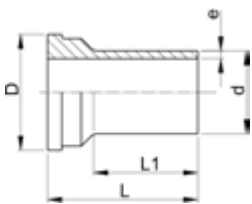

ecoFIT union end S5/SDR11

Model:

- Material: PE100
- IR = Infrared- (IR Plus) compatible.
- **For the dimensions d75-110 please see instructions for the installation**
- Conventional butt-welding according to DVS 2207

d (mm)	PN (bar)	FM	Code	Weight (kg)	D (mm)	L (mm)	L1 (mm)	e (mm)
20	16	IR	753 508 606	0.011	30	54	38	1.9
25	16	IR	753 508 607	0.018	39	57	42	2.3
32	16	IR	753 508 608	0.027	45	60	41	2.9
40	16	IR	753 508 609	0.044	57	63	42	3.7
50	16	IR	753 508 610	0.061	63	66	44	4.6
63	16	IR	753 508 611	0.100	78	69	45	5.8
75	10	IR	753 608 612	0.147	101	66	34	6.8
90	10	IR	753 608 613	0.156	101	66	55	8.2
110	10	IR	753 608 614	0.226	121	66	55	10.0



ecoFIT Union end long SDR11

Model:

- Material: PE100
- Suitable for unions, tank connectors and diaphragm valves Type 514
- For butt-, IR Plus® and electrofusion

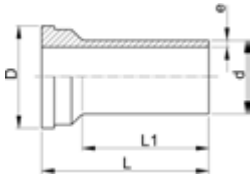

d (mm)	PN (bar)	FM	Code	Weight (kg)	D (mm)	L (mm)	L1 (mm)	e (mm)
20	16	IR	753 508 616	0.006	30	67	52	1.9
25	16	IR	753 508 617	0.019	39	71	53	2.3
32	16	IR	753 508 618	0.027	45	73	55	2.9
40	16	IR	753 508 619	0.048	57	81	60	3.7
50	16	IR	753 508 620	0.069	63	87	66	4.6
63	16	IR	753 508 621	0.120	78	93	70	5.8



ecoFIT union bush SDR11

Model:

- Material: PE100
- Conventional butt-welding according to DVS 2207
- IR = Infrared- (IR Plus) compatible.
- Gasket: O-ring EPDM
- **For the dimensions d75-110 please see instructions for the installation**

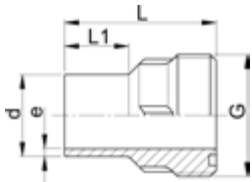

d (mm)	PN (bar)	FM	Code	Weight (kg)	G (inch)	L (mm)	L1 (mm)	e (mm)
20	16	IR	753 648 606	0.016	1	54	26	1.9
25	16	IR	753 648 607	0.025	1 1/4	57	26	2.3
32	16	IR	753 648 608	0.035	1 1/2	60	25	2.9
40	16	IR	753 648 609	0.057	2	63	25	3.7
50	16	IR	753 648 610	0.077	2 1/4	66	25	4.6
63	16	IR	753 648 611	0.128	2 3/4	69	25	5.8
75	10	IR	753 648 612	0.181	S107,5x3,6	66	24	6.8
90	10	IR	753 648 613	0.192	S107,5x3,6	66	24	8.2
110	10	IR	753 648 614	0.272	S127,5x3,6	66	25	10.0



ecoFIT union SDR17.6

Model:

- Material: PE100
- Conventional butt-welding according to DVS 2207
- Gasket: O-ring EPDM
- **For the dimensions d75-110 please see instructions for the installation**
- IR = Infrared- (IR Plus) compatible.

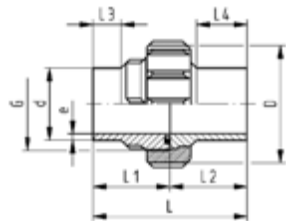

d (mm)	PN (bar)	FM	EPDM Code	FPM Code	Weight (kg)	D (mm)	G (inch)	L (mm)	L1 (mm)	L2 (mm)	e (mm)
75	10	IR	753 518 412	753 528 412	0.476	135	S107,5x3,6	132	66	66	4.3
90	10	IR	753 518 413	753 528 413	0.483	135	S107,5x3,6	131	66	66	5.1
110	10	IR	753 518 414	753 528 414	0.663	158	S127,5x3,6	131	66	66	6.3

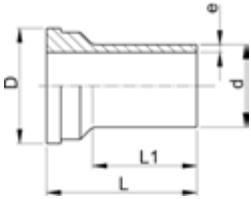

ecoFIT union end SDR17.6

Model:

- Material: PE100
- IR = Infrared- (IR Plus) compatible.
- **For the dimensions d75-110 please see instructions for the installation**
- Conventional butt-welding according to DVS 2207

d (mm)	PN (bar)	FM	Code	Weight (kg)	D (mm)	L (mm)	L1 (mm)	e (mm)
75	10	IR	753 608 412	0.124	101	66	34	4.3
90	10	IR	753 608 413	0.131	101	66	57	5.1
110	10	IR	753 608 414	0.178	121	66	55	6.3

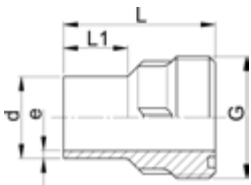

ecoFIT union bush SDR17.6

Model:

- Material: PE100
- Conventional butt-welding according to DVS 2207
- IR = Infrared- (IR Plus) compatible.
- **For the dimensions d75-110 please see instructions for the installation**

PN (bar)	d (mm)	FM	Code	Weight (kg)	G (inch)	L (mm)	L1 (mm)	e (mm)
10	75	IR	753 648 412	0.158	S107.5x3.6	66	24	4.3
10	90	IR	753 648 413	0.161	S107.5x3.6	66	24	5.1
10	110	IR	753 648 414	0.216	S127.5x3.6	66	25	6.3



ecoFIT union nut

Model:

- Material: PE-GF
- PE glass-fibre reinforced
- For the dimensions d75-110 please see instructions for the installation
- * PP glass fibre reinforced

d-d (mm)	Code	Weight (kg)	G (inch)	D (mm)	L (mm)
20	733 690 406	0.022	1	48	24
25	733 690 407	0.036	1 1/4	58	26
32	733 690 408	0.042	1 1/2	65	28
40	733 690 409	0.068	2	79	31
50	733 690 410	0.097	2 1/4	91	35
63	733 690 411	0.164	2 3/4	111	39
* 75 - 90	727 690 442	0.202	S107,5x3,6	135	40
* 90 - 110	727 690 443	0.277	S127,5x3,6	158	43

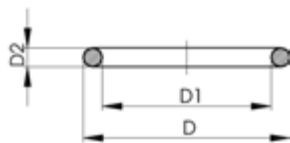

O-Ring gasket

Model:

- For unions and adaptor unions
- Hardness approx. 65° Shore
- EPDM minimum temperature -40°C
- FPM minimum temperature -15°C
- * for unions PVC-U, PVC-C and ABS: 21 51 01, 21 51 11, 21 53 03, 21 53 08, 21 55 04, 21 55 13, 21 55 18, 23 51 01 and 29 51 01 only

	d (mm)	DN (mm)	EPDM Code	Weight (kg)	FPM Code	Weight (kg)	D (mm)	D1 (mm)	D2 (mm)	closest inch (inch)
	10 - 12	8	748 410 004	0.002	749 410 004	0.020	18	12	2.62	¼
	16	10	748 410 005	0.004	749 410 005	0.002	21	16	2.62	⅜
	20	15	748 410 006	0.002	749 410 006	0.002	27	20	3.53	½
	25	20	748 410 007	0.002	749 410 007	0.002	35	28	3.53	¾
	32	25	748 410 008	0.003	749 410 008	0.002	40	33	3.53	1
	40	32	748 410 009	0.003	749 410 009	0.007	51	41	5.34	1 ¼
	50	40	748 410 010	0.004	749 410 010	0.060	58	47	5.34	1 ½
	63	50	748 410 011	0.005	749 410 011	0.003	70	60	5.34	2
	75	65	748 410 014	0.007	749 410 014	0.012	93	82	5.34	2 ½
	90	80	748 410 015	0.008	749 410 015	0.015	112	101	5.34	3
	*	90	748 410 248	0.008	749 410 248	0.020	105	95	5.34	3
	110	100	748 410 016	0.016	749 410 016	0.031	134	120	6.99	4

Valves with PE Ends



PVC-U body



DN10/15 - 50

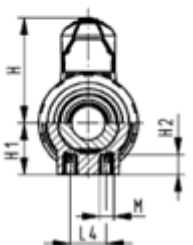
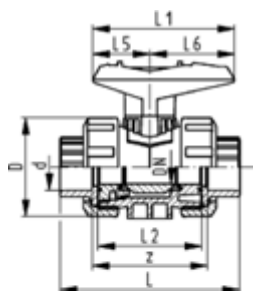

ecoFIT
Ball valve type 546
With mounting inserts
With fusion sockets PE100 metric

Model:

- Material: PVC-U/PE
- For easy installation and removal
- Ball seals PTFE
- Integrated stainless steel mounting inserts
- z-dimension, valve end and union nut are not compatible with type 346

Option:

- Individual configuration of the valve (see diagram)
- Multifunctional module with integrated limit switches
- Pneumatic or electric actuators from +GF+

d (mm)	DN (mm)	PN (bar)	kv-value ($\Delta p=1$ bar) (l/min)	EPDM Code	Weight (kg)	FPM Code	Weight (kg)
16	10	16	71	161 546 761	0.150	161 546 771	0.150
20	15	16	185	161 546 762	0.149	161 546 772	0.151
25	20	16	350	161 546 763	0.220	161 546 773	0.220
32	25	16	700	161 546 764	0.310	161 546 774	0.329
40	32	16	1000	161 546 765	0.550	161 546 775	0.550
50	40	16	1600	161 546 766	0.750	161 546 776	0.750
63	50	16	3100	161 546 767	1.360	161 546 777	1.360

d (mm)	D (mm)	H (mm)	H1 (mm)	H2 (mm)	L (mm)	L1 (mm)	L2 (mm)	L4 (mm)	L5 (mm)	L6 (mm)	M	z (mm)	closest inch (inch)
16	50	57	27	12	93	77	56	25	32	45	M6	67	3/8
20	50	57	27	12	95	77	56	25	32	45	M6	66	1/2
25	58	67	30	12	108	97	65	25	39	58	M6	77	3/4
32	68	73	36	12	119	97	71	25	39	58	M6	83	1
40	84	90	44	15	137	128	85	45	54	74	M8	99	1 1/4
50	97	97	51	15	147	128	89	45	54	74	M8	105	1 1/2
63	124	116	64	15	168	152	101	45	66	87	M8	113	2



DN10/15 - 50

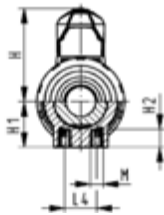
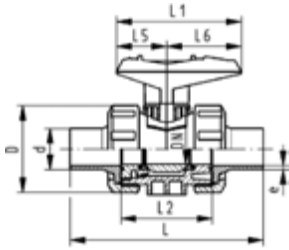

ecoFIT
Ball valve type 546
With mounting inserts
With butt fusion spigots PE100 SDR11 metric

Model:

- Material: PVC-U/PE
- For easy installation and removal
- Ball seals PTFE
- Integrated stainless steel mounting inserts
- z-dimension, valve end and union nut are not compatible with type 346

Option:

- Individual configuration of the valve (see diagram)
- Multifunctional module with integrated limit switches
- Pneumatic or electric actuators from +GF+

d (mm)	DN (mm)	PN (bar)	kv-value ($\Delta p=1$ bar) (l/min)	EPDM Code	Weight (kg)	FPM Code	Weight (kg)
20	15	16	185	161 546 782	0.151	161 546 792	0.153
25	20	16	350	161 546 783	0.231	161 546 793	0.220
32	25	16	700	161 546 784	0.329	161 546 794	0.333
40	32	16	1000	161 546 785	0.583	161 546 795	0.586
50	40	16	1600	161 546 786	0.817	161 546 796	0.826
63	50	16	3100	161 546 787	1.505	161 546 797	1.517

d (mm)	D (mm)	H (mm)	H1 (mm)	H2 (mm)	L (mm)	L1 (mm)	L2 (mm)	L4 (mm)	L5 (mm)	L6 (mm)	M	e (mm)	closest inch (inch)
20	50	57	27	12	130	77	56	25	32	45	M6	1.9	½
25	58	67	30	12	134	97	65	25	39	58	M6	2.3	¾
32	68	73	36	12	150	97	71	25	39	58	M6	2.9	1
40	84	90	44	15	171	128	85	45	54	74	M8	3.7	1 ¼
50	97	97	51	15	191	128	89	45	54	74	M8	4.6	1 ½
63	124	116	64	15	220	152	101	45	66	87	M8	5.8	2



DN10/15 - 50



ecoFIT
Ball valve type 546
With mounting inserts
With butt fusion spigots long
PE100 SDR11 metric

Model:

- Material: PVC-U/PE
- For easy installation and removal
- Ball seals PTFE
- Integrated stainless steel mounting inserts
- z-dimension, valve end and union nut are **not compatible** with type 346 (DN10/15-50) resp. type 370 (DN65-100)

Option:

- Individual configuration of the valve (see diagram)
- Multifunctional module with integrated limit switches
- Pneumatic or electric actuators from +GF+

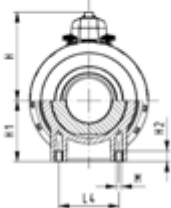
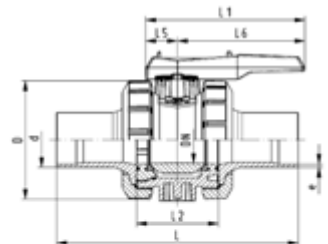
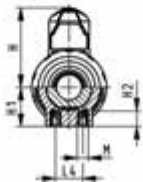
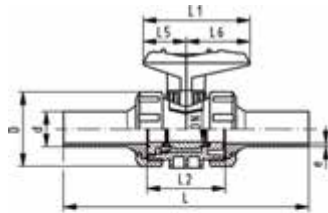

d (mm)	DN (mm)	PN (bar)	kv-value ($\Delta p=1$ bar) (L/min)	EPDM Code	Weight (kg)	FPM Code	Weight (kg)
20	15	16	185	161 546 822	0.162	161 546 832	0.150
25	20	16	350	161 546 823	0.248	161 546 833	0.220
32	25	16	700	161 546 824	0.362	161 546 834	0.310
40	32	16	1000	161 546 825	0.550	161 546 835	0.550
50	40	16	1600	161 546 826	0.886	161 546 836	0.750
63	50	16	3100	161 546 827	1.630	161 546 837	1.360
75	65	16	5000	161 546 828	3.651	161 546 838	5.000
90	80	16	7000	161 546 829	7.500	161 546 839	7.500
110	100	16	11000	161 546 830	8.860	161 546 840	11.800

d (mm)	D (mm)	H (mm)	H1 (mm)	H2 (mm)	L (mm)	L1 (mm)	L2 (mm)	L4 (mm)	L5 (mm)	L6 (mm)	M	e (mm)	closest inch (inch)
20	50	57	27	12	193	77	56	25	32	45	M6	1.9	1/2
25	58	67	30	12	216	97	65	25	39	58	M6	2.3	3/4
32	68	73	36	12	223	97	71	25	39	58	M6	2.9	1
40	84	90	44	15	249	128	85	45	54	74	M8	3.7	1 1/4
50	97	97	51	15	271	128	89	45	54	74	M8	4.6	1 1/2
63	124	116	64	15	321	152	101	45	66	87	M8	5.8	2
75	166	149	85	15	386	270	136	70	64	206	M8	6.8	2 1/2
90	200	161	105	15	421	270	141	70	64	206	M8	8.2	3
110	238	178	123	22	484	320	164	120	64	256	M12	10.0	4



DN10/15 - 50

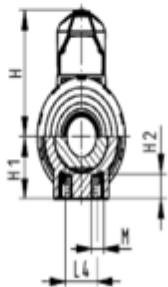
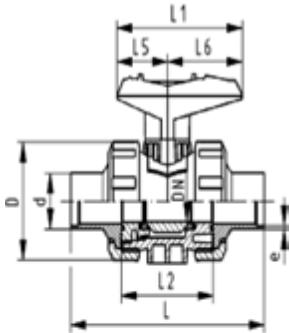

ecoFIT

Ball valve type 546

With mounting inserts

With butt fusion spigots PE100 SDR17.6 metric

Model:

- Material: PVC-U/PE
- For easy installation and removal
- Ball seals PTFE
- Integrated stainless steel mounting inserts
- z-dimension, valve end and union nut are not compatible with type 346

Option:

- Individual configuration of the valve (see diagram)
- Multifunctional module with integrated limit switches
- Pneumatic or electric actuators from +GF+

d (mm)	DN (mm)	PN (bar)	kv-value ($\Delta p=1$ bar) (l/min)	EPDM Code	Weight (kg)	FPM Code	Weight (kg)
40	32	10	1000	161 546 805	0.582	161 546 815	0.550
50	40	10	1600	161 546 806	0.750	161 546 816	0.750
63	50	10	3100	161 546 807	1.605	161 546 817	1.501

d (mm)	D (mm)	H (mm)	H1 (mm)	H2 (mm)	L (mm)	L1 (mm)	L2 (mm)	L4 (mm)	L5 (mm)	L6 (mm)	M	e (mm)	closest inch (inch)
40	84	90	44	15	171	128	85	45	54	74	M8	2.3	1 ¼
50	97	97	51	15	191	128	89	45	54	74	M8	2.9	1 ½
63	124	116	64	15	220	152	101	45	66	87	M8	3.6	2



DN10/15 - 50

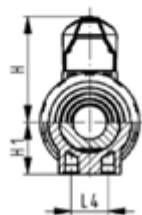
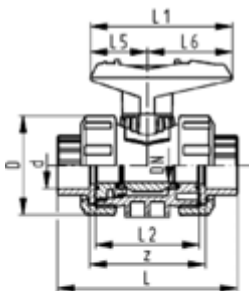

ecoFIT

Ball valve type 546

With fusion sockets PE100 metric

Model:

- Material: PVC-U/PE
- For easy installation and removal
- Ball seals PTFE
- Without mounting inserts
- z-dimension, valve end and union nut are not compatible with type 346

Option:

- Individual configuration of the valve (see diagram)
- Multifunctional module with integrated limit switches
- Pneumatic or electric actuators from +GF+

d (mm)	DN (mm)	PN (bar)	kv-value ($\Delta p=1$ bar) (l/min)	EPDM Code	Weight (kg)	FPM Code	Weight (kg)
16	10	16	71	800 000 101	0.160	800 000 111	0.170
20	15	16	185	800 000 102	0.170	800 000 112	0.170
25	20	16	350	800 000 103	0.240	800 000 113	0.240
32	25	16	700	800 000 104	0.350	800 000 114	0.340
40	32	16	1000	800 000 105	0.610	800 000 115	0.610
50	40	16	1600	800 000 106	0.840	800 000 116	0.850
63	50	16	3100	800 000 107	1.560	800 000 117	1.550

d (mm)	D (mm)	H (mm)	H1 (mm)	L (mm)	L1 (mm)	L2 (mm)	L4 (mm)	L5 (mm)	L6 (mm)	z (mm)	closest inch (inch)
16	50	57	27	93	77	56	25	32	45	67	¾
20	50	57	27	95	77	56	25	32	45	66	½
25	58	67	30	108	97	65	25	39	58	77	¾

table continued on the next page

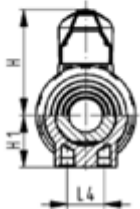
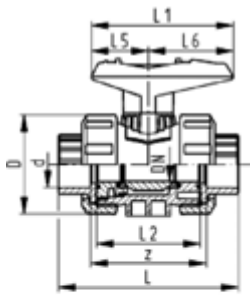

d	D	H	H1	L	L1	L2	L4	L5	L6	z	closest inch
(mm)	(mm)	(mm)	(mm)	(mm)	(mm)	(mm)	(mm)	(mm)	(mm)	(mm)	(inch)
32	68	73	36	119	97	71	25	39	58	83	1
40	84	90	44	137	128	85	45	54	74	99	1 ¼
50	97	97	51	147	128	89	45	54	74	105	1 ½
63	124	116	64	168	152	101	45	66	87	113	2



DN10/15 - 50

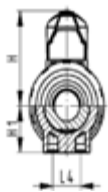
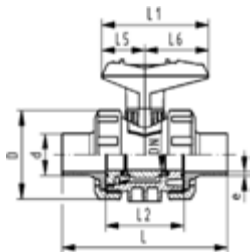

ecoFIT
Ball valve type 546
 With butt fusion spigots PE100 SDR11 metric

Model:

- Material: PVC-U/PE
- For easy installation and removal
- Ball seals PTFE
- Without mounting inserts
- z-dimension, valve end and union nut are not compatible with type 346

Option:

- Individual configuration of the valve (see diagram)
- Multifunctional module with integrated limit switches
- Pneumatic or electric actuators from +GF+

d	DN	PN	kv-value	EPDM	Weight	FPM	Weight
(mm)	(mm)	(bar)	($\Delta p=1$ bar)	Code	(kg)	Code	(kg)
			(l/min)				
20	15	16	185	800 000 142	0.116	800 000 152	0.160
25	20	16	350	800 000 143	0.227	800 000 153	0.240
32	25	16	700	800 000 144	0.340	800 000 154	0.340
40	32	16	1000	800 000 145	0.600	800 000 155	0.600
50	40	16	1600	800 000 146	0.830	800 000 156	0.830
63	50	16	3100	800 000 147	1.560	800 000 157	1.560

d	D	H	H1	L	L1	L2	L4	L5	L6	e	closest inch
(mm)	(mm)	(mm)	(mm)	(mm)	(mm)	(mm)	(mm)	(mm)	(mm)	(mm)	(inch)
20	50	57	27	130	77	56	25	32	45	1.9	½
25	58	67	30	134	97	65	25	39	58	2.3	¾
32	68	73	36	150	97	71	25	39	58	3.0	1
40	84	90	44	171	128	85	45	54	74	3.7	1 ¼
50	97	97	51	191	128	89	45	54	74	4.6	1 ½
63	124	116	64	220	152	101	45	66	87	5.8	2



DN10/15 - 50

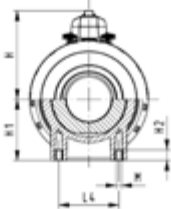
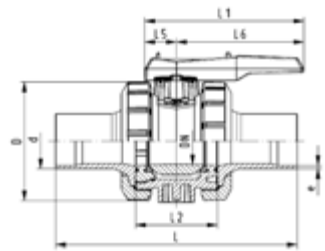
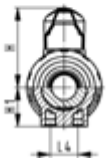
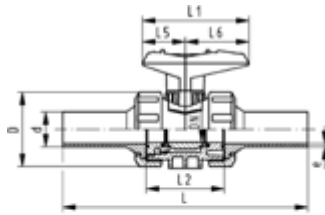

ecoFIT
Ball valve type 546
With butt fusion spigots long
PE100 SDR11 metric

Model:

- Material: PVC-U/PE
- For easy installation and removal
- Ball seals PTFE
- Without mounting inserts
- z-dimension, valve end and union nut are **not compatible** with type 346 (DN10/15-50) resp. type 370 (DN65-100)

Option:

- Individual configuration of the valve (see diagram)
- Multifunctional module with integrated limit switches
- Pneumatic or electric actuators from +GF+

d (mm)	DN (mm)	kv-value ($\Delta p=1$ bar) (l/min)	PN (bar)	EPDM Code	FPM Code	Weight (kg)
20	15	185	16	800 000 282	800 000 292	0.170
25	20	350	16	800 000 283	800 000 293	0.250
32	25	700	16	800 000 284	800 000 294	0.370
40	32	1000	16	800 000 285	800 000 295	0.640
50	40	1600	16	800 000 286	800 000 296	0.910
63	50	3100	16	800 000 287	800 000 297	1.634
75	65	5000	16	800 000 288	800 000 298	5.000
90	80	7000	16	800 000 289	800 000 299	7.500
110	100	11000	16	800 000 290	800 000 300	11.800

d (mm)	D (mm)	H (mm)	H1 (mm)	L (mm)	L1 (mm)	L2 (mm)	L4 (mm)	L5 (mm)	L6 (mm)	e (mm)	closest inch (inch)
20	50	57	27	193	77	56	25	32	45	2.2	1/2
25	58	67	30	216	97	65	25	39	58	2.3	3/4
32	68	73	36	223	97	71	25	39	58	3.0	1
40	84	90	44	249	128	85	45	54	74	3.7	1 1/4
50	97	97	51	271	128	89	45	54	74	4.6	1 1/2
63	124	116	64	321	152	101	45	66	87	5.8	2
75	166	149	85	386	270	136	70	64	206	6.8	2 1/2
90	200	161	105	421	270	141	70	64	206	8.2	3
110	238	178	123	484	320	164	120	64	256	10.0	4

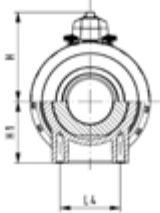
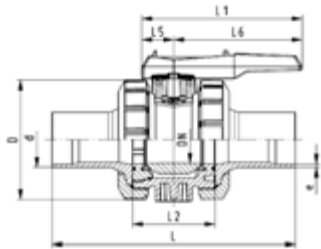

ecoFIT
Ball valve type 546
 With butt fusion spigots long
 PE100 SDR17.6 metric

Model:

- Material: PVC-U/PE
- For easy installation and removal
- Ball seals PTFE
- Without mounting inserts
- z-dimension, valve end and union nut are **not compatible** with type 346 (DN10/15-50) resp. type 370 (DN65-100)
- Image and drawing DN65-100 please see "New product ball valve DN65-100"

Option:

- Individual configuration of the valve (see diagram)
- Multifunctional module with integrated limit switches
- Pneumatic or electric actuators from +GF+

d (mm)	DN (mm)	PN (bar)	kv-value ($\Delta p=1$ bar) (L/min)	EPDM Code	FPM Code	Weight (kg)
75	65	16	5000	800 000 218	800 000 228	5.000
90	80	16	7000	800 000 219	800 000 229	7.400
110	100	16	11000	800 000 220	800 000 230	11.700

d (mm)	D (mm)	H (mm)	H1 (mm)	L (mm)	L1 (mm)	L2 (mm)	L4 (mm)	L5 (mm)	L6 (mm)	e (mm)	closest inch (inch)
75	166	149	85	386	270	136	70	64	206	4.3	2 1/2
90	200	161	105	421	270	141	70	64	206	5.1	3
110	238	178	123	484	320	164	120	64	256	6.3	4



DN10/15 - 50

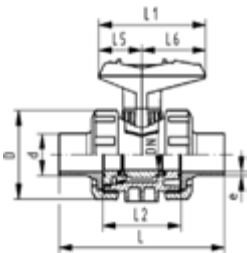

ecoFIT
Ball valve type 546
 With butt fusion spigots PE100 SDR17.6 metric

Model:

- Material: PVC-U/PE
- For easy installation and removal
- Ball seals PTFE
- Without mounting inserts
- z-dimension, valve end and union nut are not compatible with type 346

Option:

- Individual configuration of the valve (see diagram)
- Multifunctional module with integrated limit switches
- Pneumatic or electric actuators from +GF+

d (mm)	DN (mm)	PN (bar)	kv-value ($\Delta p=1$ bar) (L/min)	EPDM Code	Weight (kg)	FPM Code	Weight (kg)
40	32	10	1000	800 000 125	0.600	800 000 135	0.600
50	40	10	1600	800 000 126	0.830	800 000 136	0.830
63	50	10	3100	800 000 127	1.560	800 000 137	1.560

d (mm)	D (mm)	H (mm)	H1 (mm)	L (mm)	L1 (mm)	L2 (mm)	L4 (mm)	L5 (mm)	L6 (mm)	e (mm)	closest inch (inch)
40	84	90	44	171	128	85	45	54	74	2.3	1 1/4
50	97	97	51	191	128	89	45	54	74	2.9	1 1/2
63	124	116	64	220	152	101	45	66	87	3.6	2



ecoFIT
3-Way ball valve type 543
Horizontal/L-port
With butt fusion spigots long
PE100 SDR11 metric

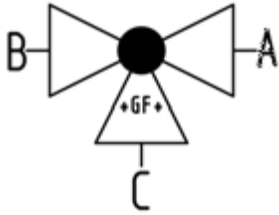

Model:

- Material: PVC-U/PE
- For easy installation and removal (valve end and union nut are compatible with type 546)
- Ball seals PTFE
- Pneumatic or electric actuator available separately
- Angle of operation 360° without turn limiter
- Turn limiter 90° enclosed, in different positions usable as a clip-on ring
- Integrated stainless steel mounting inserts
- Delivery status A-C opened, see flow scheme

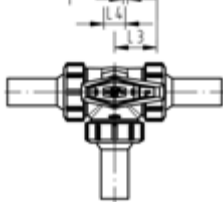
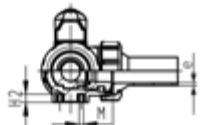
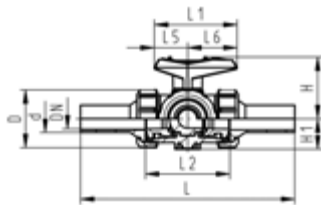
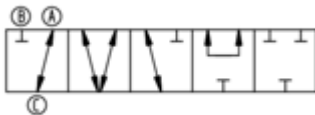

d	DN	PN	kv-value	EPDM	Weight	FPM	Weight
(mm)	(mm)	(bar)	($\Delta p=1$ bar)	Code	(kg)	Code	(kg)
			(l/min)				
20	15	10	75	161 543 462	0.254	161 543 472	0.254
25	20	10	150	161 543 463	0.370	161 543 473	0.370
32	25	10	280	161 543 464	0.563	161 543 474	0.563
40	32	10	480	161 543 465	0.953	161 543 475	0.953
50	40	10	620	161 543 466	1.444	161 543 476	1.444
63	50	10	1230	161 543 467	3.141	161 543 477	3.141

d	D	L	L1	L2	L3	L4	L5	L6	H	H1	H2	M	e	closest
(mm)	(mm)	(mm)	(mm)	(mm)	(mm)	(mm)	(mm)	(mm)	(mm)	(mm)	(mm)	(mm)	(mm)	inch
														(inch)
20	50	210	77	73	36	25	32	45	57	28	8	6	2.3	½
25	58	237	97	86	43	25	39	58	67	32	8	6	2.3	¾
32	68	251	97	99	50	25	39	58	73	36	8	6	2.9	1
40	84	283	128	120	60	45	54	74	90	45	9	8	3.7	1 ¼
50	97	319	128	137	69	45	54	74	97	51	9	8	4.6	1 ½
63	124	399	152	179	89	45	66	87	116	65	9	8	5.8	2



ecoFIT
3-Way ball valve type 543
Horizontal/T-port
With butt fusion spigots long
PE100 SDR11 metric

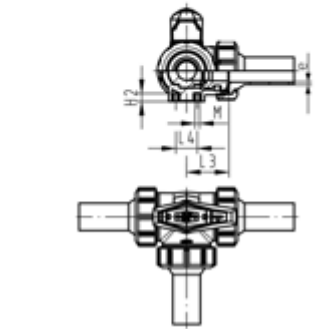
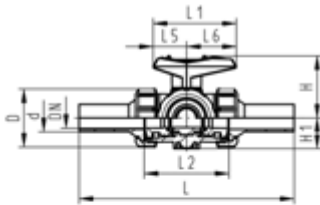
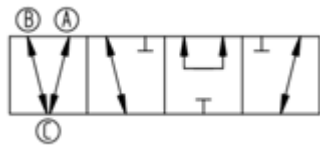
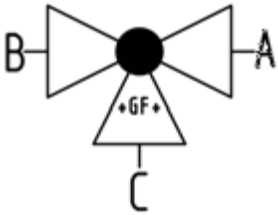

Model:

- Material: PVC-U/PE
- For easy installation and removal (valve end and union nut are compatible with type 546)
- Ball seals PTFE
- Pneumatic or electric actuator available separately
- Angle of operation 360° without turn limiter
- Turn limiter 90° enclosed, in different positions usable as a clip-on ring
- Integrated stainless steel mounting inserts
- Delivery status A-B-C opened, see flow scheme

d	DN	PN	kv-value	EPDM	Weight	FPM	Weight
(mm)	(mm)	(bar)	($\Delta p=1$ bar)	Code	(kg)	Code	(kg)
			(l/min)				
20	15	10	200	161 543 482	0.253	161 543 492	0.253
25	20	10	470	161 543 483	0.368	161 543 493	0.368
32	25	10	793	161 543 484	0.556	161 543 494	0.556
40	32	10	1290	161 543 485	0.942	161 543 495	0.942
50	40	10	1910	161 543 486	1.423	161 543 496	1.423
63	50	10	3100	161 543 487	2.770	161 543 497	3.096

d	D	L	L1	L2	L3	L4	L5	L6	H	H1	H2	M	e	closest
(mm)	(mm)	(mm)	(mm)	(mm)	(mm)	(mm)	(mm)	(mm)	(mm)	(mm)	(mm)	(mm)	(mm)	inch
														(inch)
20	50	210	77	73	36	25	32	45	57	28	8	6	2.3	½
25	58	237	97	86	43	25	39	58	67	32	8	6	2.3	¾
32	68	251	97	99	50	25	39	58	73	36	8	6	2.9	1
40	84	283	128	120	60	45	54	74	90	45	9	8	3.7	1 ¼
50	97	319	128	137	69	45	54	74	97	51	9	8	4.6	1 ½
63	124	399	152	179	89	45	66	87	116	65	9	8	5.8	2

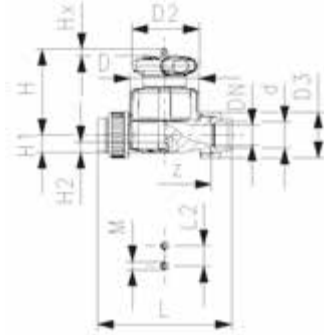

ecoFIT
Diaphragm valve type 514
With fusion sockets PE80 metric

Model:

- Material: PVC-U/PE
- Double flow rate compared to predecessor
- One housing nut replaces four screws
- Handwheel with built-in locking mechanism
- For easy installation and removal
- Short overall length

Option:

- Individual configuration of the valve (see diagram)
- Self adjusting multifunctional module with integrated limit switches
- PN16 available as a configuration

d (mm)	DN (mm)	PN (bar)	kv-value ($\Delta p=1$ bar) (l/min)	EPDM Code	Weight (kg)
20	15	10	125	161 514 212	0.290
25	20	10	271	161 514 213	0.416
32	25	10	481	161 514 214	0.662
40	32	10	759	161 514 215	1.405
50	40	10	1263	161 514 216	2.492
63	50	10	1728	161 514 217	3.331

d (mm)	D (mm)	D2 (mm)	D3 (mm)	L (mm)	L2 (mm)	H (mm)	H1 (mm)	H2 (mm)	M	z (mm)	Lift = Hx (mm)	closest inch (inch)
20	65	65	43	128	25	73	14	12	M6	100	7	½
25	80	65	51	150	25	81	18	12	M6	118	10	¾
32	88	87	58	162	25	107	22	12	M6	126	13	1
40	101	87	72	184	45	115	26	15	M8	144	15	1 ¼
50	117	135	83	210	45	148	32	15	M8	164	19	1 ½
63	144	135	100	248	45	166	39	15	M8	194	25	2

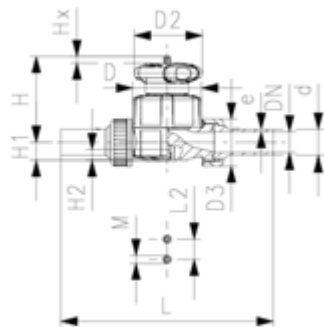

ecoFIT
Diaphragm valve type 514
With butt and electro fusion ends PE100 SDR11 metric

Model:

- Material: PVC-U/PE
- Double flow rate compared to predecessor
- One housing nut replaces four screws
- Handwheel with built-in locking mechanism
- For easy installation and removal
- Short overall length

Option:

- Individual configuration of the valve (see diagram)
- Self adjusting multifunctional module with integrated limit switches
- PN16 available as a configuration

d (mm)	DN (mm)	PN (bar)	kv-value ($\Delta p=1$ bar) (l/min)	EPDM Code	Weight (kg)
20	15	10	125	161 514 312	0.357
25	20	10	271	161 514 313	0.431
32	25	10	481	161 514 314	0.683
40	32	10	759	161 514 315	1.443
50	40	10	1263	161 514 316	1.663
63	50	10	1728	161 514 317	2.568

table continued on the next page

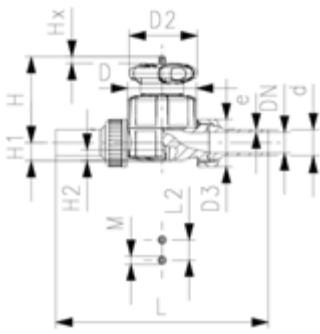

d (mm)	D (mm)	D2 (mm)	D3 (mm)	L (mm)	L2 (mm)	H (mm)	H1 (mm)	H2 (mm)	M	Lift = Hx (mm)	e (mm)	closest inch (inch)
20	65	65	43	196	25	73	14	12	M6	7	1.9	½
25	80	65	51	221	25	81	18	12	M6	10	2.3	¾
32	88	87	58	234	25	107	22	12	M6	13	2.9	1
40	101	87	72	260	45	115	26	15	M8	15	3.7	1 ¼
50	117	135	83	284	45	148	32	15	M8	19	4.6	1 ½
63	144	135	100	321	45	166	39	15	M8	25	5.8	2



Butterfly valve type 567 PVC-U Hand lever with ratchet settings

Model:

- Up to DN 300: Overall length according to EN558 (DN 50-200: line 25, DN250, 300 line 16), ISO 5752
- Connecting dimension: ISO 7005 PN 10, EN 1092 PN 10, DIN 2501 PN 10, ANSI/ASME B 16.5 Class 150, BS 1560: 1989, BS 4504, JIS B 2220
- We recommend for the dimensions DN250 and DN300 only 6 bar maximum system pressure for the hand lever version

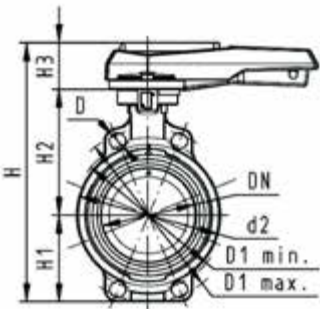

d (mm)	Size (inch)	DN (mm)	PN (bar)	kv-value (Δp=1 bar) (l/min)	EPDM Code	FPM Code	Weight (kg)
63	2	50	10	1470	161 567 002	161 567 022	1.259
75	2 ½	65	10	2200	161 567 003	161 567 023	1.799
90	3	80	10	3000	161 567 004	161 567 024	1.534
110	4	100	10	6500	161 567 005	161 567 025	2.235
140	5	125	10	11500	161 567 006	161 567 026	2.799
160	6	150	10	16600	161 567 007	161 567 027	3.791
225	8	200	10	39600	161 567 008	161 567 028	6.570
280	10	250	10	55200	161 567 009	161 567 029	12.998
315	12	300	10	80000	161 567 010	161 567 030	19.139

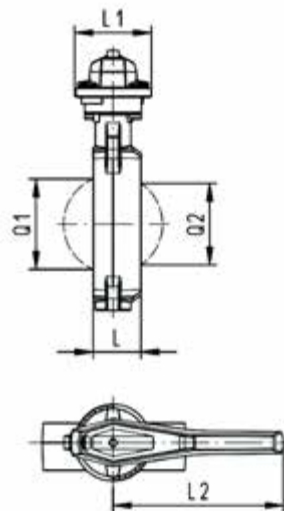

d (mm)	D (mm)	D1 min. (mm)	D1 max. (mm)	d2 (mm)	H (mm)	H1 (mm)	H2 (mm)	H3 (mm)	L (mm)	L1 (mm)	L2 (mm)	Q1 (mm)	Q2 (mm)
63	19	120.0	125.0	104	265	77	134	54	45	106	205	40	35
75	19	139.7	145.0	115	268	83	140	45	46	106	205	54	
90	19	150.0	160.0	131	289	89	146	54	49	106	205	67	50
110	19	175.0	190.5	161	326	104	167	55	56	106	255	88	74
140	23	210.0	215.9	187	353	117	181	55	64	106	255	113	97
160	24	241.3	241.3	215	374	130	189	55	72	106	255	139	123
225	23	290.0	295.0	267	435	158	210	67	73	140	408	178	169
280	25	353.0	362.0	329	554	205	264	85	113	149	408	210	207
315	25	400.0	432.0	379	598	228	285	85	113	149	408	256	253



Lugstyle butterfly valve type 578 PVC-U
Hand lever with ratchet settings

Model:

- Housing material: PP-GF30 with SS316 lug-inserts
- Overall length according to EN 558, ISO 5752 (DN50 - 200 line 25, DN250 - 300 line 10)
- Connecting dimension: ISO 7005 PN10, EN 1092 PN10, DIN 2501 PN10
- We recommend for the dimensions DN250 and DN300 only 6 bar maximum system pressure for the hand lever version

Option:

- Optional accessory: Valve-Integrated position feedback with limit switches (limit switches have to be ordered separately)

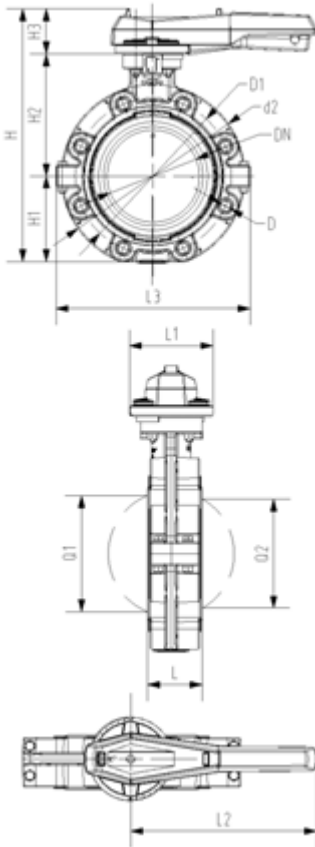

d	Size	DN	PN	kv-value	EPDM	Weight	FPM	Weight
(mm)	(inch)	(mm)	(bar)	($\Delta p=1$ bar)	Code	(kg)	Code	(kg)
				(l/min)				
63	2	50	10	1470	161 578 002	1.800	161 578 022	1.800
75	2 ½	65	10	2200	161 578 003	1.895	161 578 023	1.895
90	3	80	10	3000	161 578 004	2.251	161 578 024	2.251
110	4	100	10	6500	161 578 005	3.146	161 578 025	3.146
140	5	125	10	11500	161 578 006	4.660	161 578 026	4.660
160	6	150	10	16600	161 578 007	6.430	161 578 027	6.430
225	8	200	10	39600	161 578 008	8.625	161 578 028	8.625
280	10	250	10	55200	161 578 009	19.528	161 578 029	19.528
315	12	300	10	80000	161 578 010	26.106	161 578 030	26.106

d	d2	D	D1	D3	H	H1	H2	H3	L	L1	L2	L3	Q1	Q2
(mm)	(mm)	(mm)	(mm)	(mm)	(mm)	(mm)	(mm)	(mm)	(mm)	(mm)	(mm)	(mm)	(mm)	(mm)
63	160	M16	125	27	265	77	134	62	45	78	112	179	40	
75	180	M16	145	27	277	83	140	62	46	78	112	179	54	35
90	195	M16	160	27	289	89	146	62	49	78	112	179	67	50
110	226	M16	180	27	328	106	167	62	56	78	112	179	88	74
140	258	M16	210	27	357	121	181	62	64	78	112	179	113	97
160	284	M20	240	27	377	133	189	62	72	78	112	179	139	123
225	341	M20	295	27	436	159	210	62	73	78	112	179	178	169
280	412	M20	350	200	536	205	264	69	113	97	130	198	210	207
315	482	M20	400	200	586	234	285	69	113	97	130	198	256	253



ecoFIT
Check valve type 561
With butt fusion spigots long
PE100 SDR11 metric

Model:

- Material: PVC-U/PE
- Designed for easy installation and removal
- Vibration free even at high flow velocity
- Flow-optimized return cone, double guided
- For vertical installation
- Compact installation length, same as ball valve type 546
- Z-length, end connectors and union nuts **not** compatible with type 360

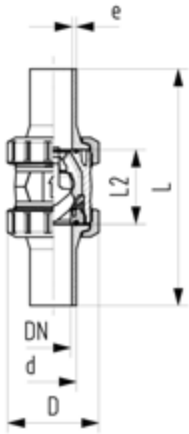

d (mm)	DN (mm)	PN (bar)	kv-value ($\Delta p=1$ bar) (l/min)	EPDM Code	Weight (kg)	FPM Code	Weight (kg)
20	15	16	180	161 561 142	0.130	800 050 344	0.130
25	20	16	380	161 561 143	0.260	800 050 345	0.250
32	25	16	460	161 561 144	0.300	800 050 346	0.320
40	32	16	850	161 561 145	0.520	800 050 308	0.530
50	40	16	1080	161 561 146	0.780	800 050 347	0.810
63	50	16	1670	161 561 147	1.410	800 050 348	1.530
75	65	10	2950	161 561 148	3.260	800 050 837	3.160
90	80	10	3600	161 561 149	5.170	800 050 838	5.520
110	100	10	4150	161 561 150	8.310	800 050 839	8.930

d (mm)	D (mm)	L (mm)	L2 (mm)	e (mm)	closest inch (inch)
20	50	193	56	2.3	½
25	58	216	65	2.3	¾
32	68	223	71	3.0	1
40	84	249	85	3.7	1 ¼
50	97	271	89	4.6	1 ½
63	124	321	101	5.8	2
75	166	386	136		2 ½
90	200	421	141	8.2	3
110	238	484	164	10.0	4

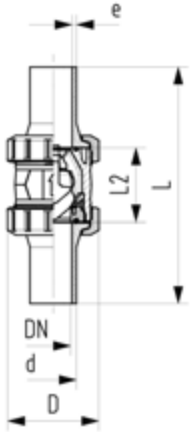

ecoFIT
Check valve type 562
With butt fusion spigots long
PE100 SDR11 metric

Model:

- Material: PVC-U/PE
- For horizontal or vertical installation
- Spring loaded, spring made of stainless steel (1.4310)
- Spring available in other materials, see spare parts
- Designed for easy installation and removal
- Vibration free even at high flow velocity
- Flow-optimized return cone, double guided
- Compact installation length, same as ball valve type 546
- Z-length, end connectors and union nuts **not** compatible with type 360

d	DN	PN	kv-value	EPDM	Weight	D	L	L2	e	closest
(mm)	(mm)	(bar)	($\Delta p=1$ bar)	Code	(kg)	(mm)	(mm)	(mm)	(mm)	inch
			(l/min)							
20	15	16	180	161 562 142	0.130	50	193	56	2.3	½
25	20	16	380	161 562 143	0.260	58	216	65	2.3	¾
32	25	16	460	161 562 144	0.300	68	223	71	3.0	1
40	32	16	850	161 562 145	0.520	84	249	85	3.7	1 ¼
50	40	16	1080	161 562 146	0.780	97	271	89	4.6	1 ½
63	50	16	1670	161 562 147	1.410	124	321	101	5.8	2
75	65	10	2950	161 562 148	3.260	166	386	136	6.8	2 ½
90	80	10	3600	161 562 149	5.170	200	421	141	8.2	3
110	100	16	4150	161 562 150	8.310	238	484	164	10.0	4

ABS body



DN10/15 - 50

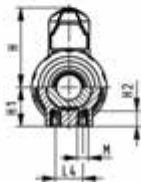
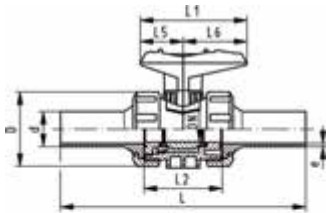

ecoFIT
Ball valve type 546
With mounting inserts
With butt fusion spigots long
PE100 SDR11 metric

Model:

- Material: ABS/PE
- For easy installation and removal
- Ball seals PTFE
- Integrated stainless steel mounting inserts
- z-dimension, valve end and union nut are **not compatible** with type 346 (DN10/15-50) resp. type 370 (DN65-100)

Option:

- Individual configuration of the valve (see diagram)
- Multifunctional module with integrated limit switches
- Pneumatic or electric actuators from +GF+

d	DN	PN	kv-value	EPDM	Weight
(mm)	(mm)	(bar)	($\Delta p=1$ bar)	Code	(kg)
			(l/min)		
20	15	10	185	800 024 832	0.150
25	20	10	350	800 024 834	0.220
32	25	10	700	800 015 141	0.310
40	32	10	1000	800 015 142	0.530
50	40	10	1600	800 015 179	0.740
63	50	10	3100	800 015 143	1.370
75	65	10	5000	800 045 326	3.900
90	80	10	7000	800 045 327	3.900
110	100	10	11000	800 045 328	3.900

table continued on the next page

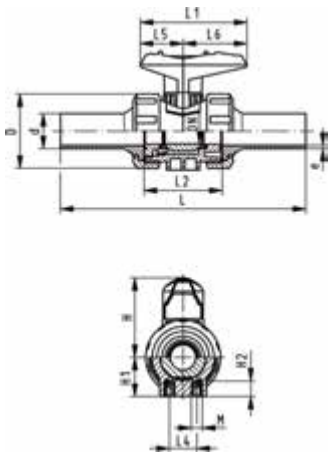

d (mm)	D (mm)	H (mm)	H1 (mm)	H2 (mm)	L (mm)	L1 (mm)	L2 (mm)	L4 (mm)	L5 (mm)	L6 (mm)	M	e (mm)	closest inch (inch)
20	50	57	27	12	193	77	56	25	32	45	M6	1.9	1/2
25	58	67	30	12	216	97	65	25	39	58	M6	2.3	3/4
32	68	73	36	12	223	97	71	25	39	58	M6	2.9	1
40	84	90	44	15	249	128	85	45	54	74	M8	3.7	1 1/4
50	97	97	51	15	271	128	89	45	54	74	M8	4.6	1 1/2
63	124	116	64	15	321	152	101	45	66	87	M8	5.8	2
75	166	149	85	15	386	270	136	70	64	206	M8	6.8	2 1/2
90	200	161	105	15	421	270	141	70	64	206	M8	8.2	3
110	238	178	123	22	484	320	164	120	64	256	M12	10.0	4



ecoFIT
3-Way ball valve type 543
Horizontal/L-port
With butt fusion spigots long
PE100 SDR11 metric

Model:

- Material: ABS/PE
- For easy installation and removal (valve end and union nut are compatible with type 546)
- Ball seals PTFE
- Pneumatic or electric actuator available separately
- Angle of operation 360° without turn limiter
- Turn limiter 90° enclosed, in different positions usable as a clip-on ring
- Integrated stainless steel mounting inserts
- Delivery status A-C opened, see flow scheme

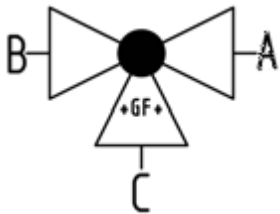

d (mm)	DN (mm)	PN (bar)	kv-value (Δp=1 bar) (l/min)	EPDM Code	Weight (kg)
20	15	10	75	169 543 302	0.203
25	20	10	150	169 543 303	0.296
32	25	10	280	169 543 304	0.450
40	32	10	480	169 543 305	0.762
50	40	10	620	169 543 306	1.161
63	50	10	1230	169 543 307	2.509

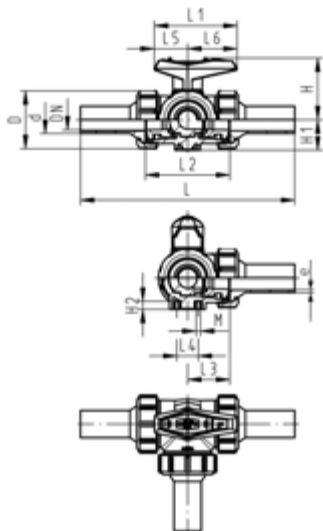
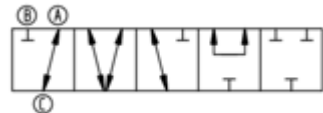

d (mm)	D (mm)	L (mm)	L1 (mm)	L2 (mm)	L3 (mm)	L4 (mm)	L5 (mm)	L6 (mm)	H (mm)	H1 (mm)	H2 (mm)	M	e (mm)	closest inch (inch)
20	50	210	77	73	36	25	32	45	57	28	8	6	2.3	1/2
25	58	237	97	86	43	25	39	58	67	32	8	6	2.3	3/4
32	68	251	97	99	50	25	39	58	73	36	8	6	2.9	1
40	84	283	128	120	60	45	54	74	90	45	9	8	3.7	1 1/4
50	97	319	128	137	69	45	54	74	97	51	9	8	4.6	1 1/2
63	124	399	152	179	89	45	66	87	116	65	9	8	5.8	2



ecoFIT
3-Way ball valve type 543
Horizontal/T-port
With butt fusion spigots long
PE100 SDR11 metric

Model:

- Material: ABS/PE
- For easy installation and removal (valve end and union nut are compatible with type 546)
- Ball seals PTFE
- Pneumatic or electric actuator available separately
- Angle of operation 360° without turn limiter
- Turn limiter 90° enclosed, in different positions usable as a clip-on ring
- Integrated stainless steel mounting inserts
- Delivery status A-B-C opened, see flow scheme

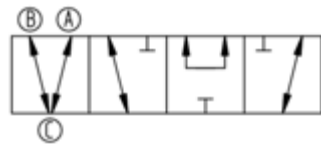
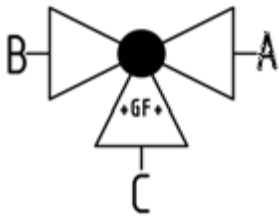
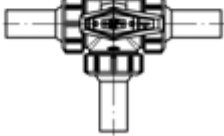
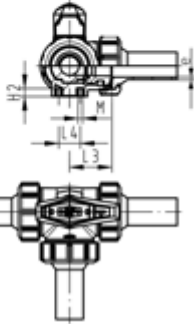
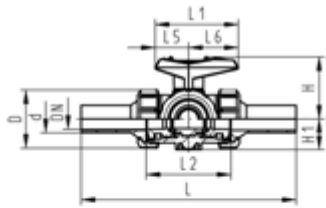

d (mm)	DN (mm)	PN (bar)	kv-value ($\Delta p=1$ bar) (l/min)	EPDM Code	Weight (kg)
20	15	10	200	169 543 322	0.203
25	20	10	470	169 543 323	0.296
32	25	10	793	169 543 324	0.450
40	32	10	1290	169 543 325	0.762
50	40	10	1910	169 543 326	1.161
63	50	10	3100	169 543 327	2.509

d (mm)	D (mm)	L (mm)	L1 (mm)	L2 (mm)	L3 (mm)	L4 (mm)	L5 (mm)	L6 (mm)	H (mm)	H1 (mm)	H2 (mm)	M (mm)	e (mm)	closest inch (inch)
20	50	210	77	73	36	25	32	45	57	28	8	6	2.3	1/2
25	58	237	97	86	43	25	39	58	67	32	8	6	2.3	3/4
32	68	251	97	99	50	25	39	58	73	36	8	6	2.9	1
40	84	283	128	120	60	45	54	74	90	45	9	8	3.7	1 1/4
50	97	319	128	137	69	45	54	74	97	51	9	8	4.6	1 1/2
63	124	399	152	179	89	45	66	87	116	65	9	8	5.8	2

PP body



DN10/15 - 50

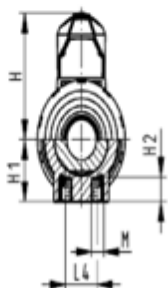
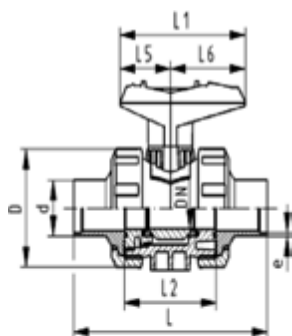

ecoFIT
Ball valve type 546
With mounting inserts
With butt fusion spigots PE100 SDR11 metric

Model:

- Material: PP-H/PE
- For easy installation and removal
- Ball seals PTFE
- Integrated stainless steel mounting inserts
- z-dimension, valve end and union nut are not compatible with type 346

Option:

- Individual configuration of the valve (see diagram)
- Multifunctional module with integrated limit switches
- Pneumatic or electric actuators from +GF+

d (mm)	DN (mm)	PN (bar)	kv-value ($\Delta p=1$ bar) (l/min)	EPDM Code	Weight (kg)	FPM Code	Weight (kg)
20	15	10	185	167 546 142	0.120	167 546 152	0.120
25	20	10	350	167 546 143	0.184	167 546 153	0.180
32	25	10	700	167 546 144	0.262	167 546 154	0.255
40	32	10	1000	167 546 145	0.440	167 546 155	0.440
50	40	10	1600	167 546 146	0.637	167 546 156	0.620
63	50	10	3100	167 546 147	1.176	167 546 157	1.200

d (mm)	D (mm)	H (mm)	H1 (mm)	H2 (mm)	L (mm)	L1 (mm)	L2 (mm)	L3 (mm)	L4 (mm)	L5 (mm)	L6 (mm)	M	e (mm)	closest inch (inch)
20	50	57	27	12	130	77	56	130	25	32	45	M6	1.9	1/2
25	58	67	30	12	143	97	65	150	25	39	58	M6	2.3	3/4
32	68	73	36	12	150	97	71	160	25	39	58	M6	2.9	1
40	84	90	44	15	171	128	85	180	45	54	74	M8	3.7	1 1/4
50	97	97	51	15	191	128	89	200	45	54	74	M8	4.6	1 1/2
63	124	116	64	15	220	152	101	230	45	66	87	M8	5.8	2



DN10/15 - 50

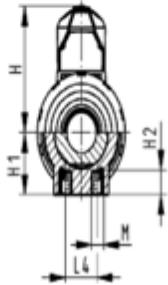
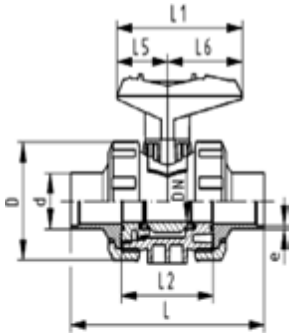

ecoFIT
Ball valve type 546
With mounting inserts
With butt fusion spigots PE100 SDR17.6 metric

Model:

- Material: PP-H/PE
- For easy installation and removal
- Ball seals PTFE
- Integrated stainless steel mounting inserts
- z-dimension, valve end and union nut are not compatible with type 346

Option:

- Individual configuration of the valve (see diagram)
- Multifunctional module with integrated limit switches
- Pneumatic or electric actuators from +GF+

d (mm)	DN (mm)	PN (bar)	kv-value ($\Delta p=1$ bar) (l/min)	EPDM Code	Weight (kg)	FPM Code	Weight (kg)
50	40	6	1600	167 546 126	0.620	167 546 136	0.620
63	50	6	3100	167 546 127	1.200	167 546 137	1.200

d (mm)	closest inch (inch)	D (mm)	H (mm)	H1 (mm)	H2 (mm)	L (mm)	L1 (mm)	L2 (mm)	L4 (mm)	L5 (mm)	L6 (mm)	M	e (mm)
50	1 ½	97	97	51	15	191	128	89	45	54	74	M8	2.9
63	2	124	116	64	15	220	152	101	45	66	87	M8	3.6



DN10/15 - 50

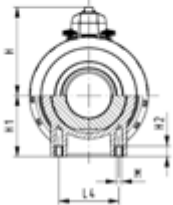
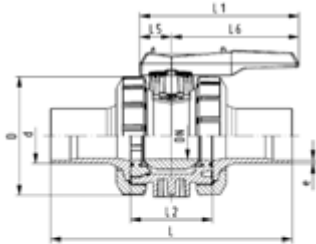
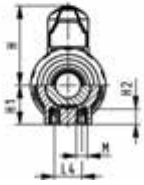
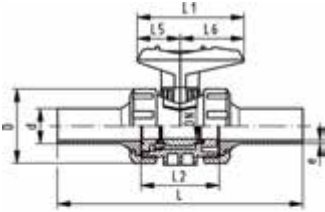

ecoFIT
Ball valve type 546
With mounting inserts
With butt fusion spigots long
PE100 SDR11 metric

Model:

- Material: PP-H/PE
- For easy installation and removal
- Ball seals PTFE
- Integrated stainless steel mounting inserts
- z-dimension, valve end and union nut are **not compatible** with type 346 (DN10/15-50) resp. type 370 (DN65-100)

Option:

- Individual configuration of the valve (see diagram)
- Multifunctional module with integrated limit switches
- Pneumatic or electric actuators from +GF+

d (mm)	DN (mm)	PN (bar)	kv-value ($\Delta p=1$ bar) (L/min)	EPDM Code	Weight (kg)	FPM Code	Weight (kg)
20	15	10	185	167 546 282	0.131	167 546 292	0.130
25	20	10	350	167 546 283	0.195	167 546 293	0.195
32	25	10	700	167 546 284	0.285	167 546 294	0.280
40	32	10	1000	167 546 285	0.485	167 546 295	0.485
50	40	10	1600	167 546 286	0.703	167 546 296	0.695
63	50	10	3100	167 546 287	1.296	167 546 297	1.309
75	65	10	5000	167 546 288	2.788	167 546 298	3.900
90	80	10	7000	167 546 289	5.569	167 546 299	5.900
110	100	10	11000	167 546 290	9.300	167 546 300	9.300

d (mm)	D (mm)	H (mm)	H1 (mm)	H2 (mm)	L (mm)	L1 (mm)	L2 (mm)	L4 (mm)	L5 (mm)	L6 (mm)	M	e (mm)	closest inch (inch)
20	50	57	27	12	193	77	56	25	32	45	M6	2.3	1/2
25	58	67	30	12	216	97	65	25	39	58	M6	2.3	3/4
32	68	73	36	12	223	97	71	25	39	58	M6	2.9	1
40	84	90	44	15	249	128	85	45	54	74	M8	3.7	1 1/4
50	97	97	51	15	271	128	89	45	54	74	M8	4.6	1 1/2
63	124	116	64	15	321	152	101	45	66	87	M8	5.8	2
75	166	149	85	15	386	270	136	70	64	206	M8	6.8	2 1/2
90	200	161	105	15	421	270	141	70	64	206	M8	8.2	3
110	238	178	123	22	484	320	164	120	64	256	M12	10.0	4



DN10/15 - 50

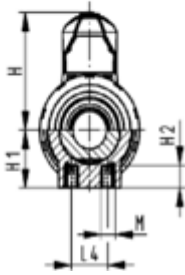
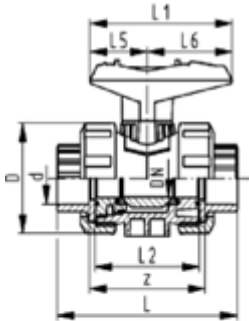

ecoFIT
Ball valve type 546
With mounting inserts
With fusion sockets PE100 metric

Model:

- Material: PP-H/PE
- For easy installation and removal
- Ball seals PTFE
- Integrated stainless steel mounting inserts
- z-dimension, valve end and union nut are not compatible with type 346

Option:

- Individual configuration of the valve (see diagram)
- Multifunctional module with integrated limit switches
- Pneumatic or electric actuators from +GF+

d (mm)	DN (mm)	PN (bar)	kv-value ($\Delta p=1$ bar) (l/min)	EPDM Code	Weight (kg)	FPM Code	Weight (kg)
16	10	10	71	167 546 161	0.120	167 546 171	0.120
20	15	10	185	167 546 162	0.120	167 546 172	0.120
25	20	10	350	167 546 163	0.180	167 546 173	0.180
32	25	10	700	167 546 164	0.258	167 546 174	0.260
40	32	10	1000	167 546 165	0.450	167 546 175	0.450
50	40	10	1600	167 546 166	0.630	167 546 176	0.630
63	50	10	3100	167 546 167	1.113	167 546 177	1.195

d (mm)	D (mm)	H (mm)	H1 (mm)	H2 (mm)	L (mm)	L1 (mm)	L2 (mm)	L4 (mm)	L5 (mm)	L6 (mm)	M (mm)	z (mm)	closest inch (inch)
16	50	57	27	12	93	77	56	25	32	45	M6	67	3/8
20	50	57	27	12	95	77	56	25	32	45	M6	67	1/2
25	58	67	30	12	109	97	65	25	39	58	M6	77	3/4
32	68	73	36	12	119	97	71	25	39	58	M6	83	1
40	84	90	44	15	135	128	85	45	54	74	M8	99	1 1/4
50	97	97	51	15	147	128	89	45	54	74	M8	105	1 1/2
63	124	116	64	15	168	152	101	45	66	87	M8	113	2

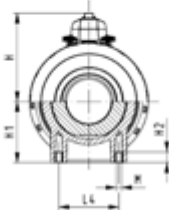
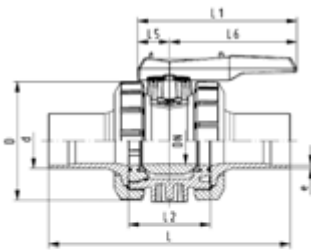

ecoFIT
Ball valve type 546
With mounting inserts
With butt fusion spigots long
PE100 SDR17,6 metric

Model:

- Material: PP-H/PE
- For easy installation and removal
- Ball seals PTFE
- Integrated stainless steel mounting inserts
- z-dimension, valve end and union nut are **not compatible** with type 346 (DN10/15-50) resp. type 370 (DN65-100)

Option:

- Individual configuration of the valve (see diagram)
- Multifunctional module with integrated limit switches
- Pneumatic or electric actuators from +GF+

d (mm)	DN (mm)	PN (bar)	kv-value ($\Delta p=1$ bar) (l/min)	EPDM Code	Weight (kg)	FPM Code	Weight (kg)
75	65	10	5000	167 546 308	3.003	167 546 318	3.900
90	80	10	7000	167 546 309	5.800	167 546 319	2.026
110	100	10	11000	167 546 310	9.200	167 546 320	9.200

table continued on the next page

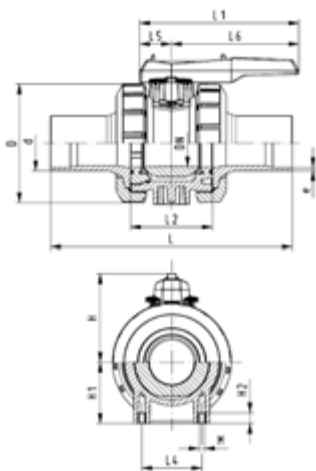

d (mm)	D (mm)	H (mm)	H1 (mm)	H2 (mm)	L (mm)	L1 (mm)	L2 (mm)	L4 (mm)	L5 (mm)	L6 (mm)	M	e (mm)	closest inch (inch)
75	166	149	85	15	386	270	136	70	64	206	8	4.3	2 1/2
90	200	161	105	15	421	270	141	70	64	206	8	5.1	3
110	238	178	123	22	484	320	164	120	64	256	12	6.3	4



ecoFIT
3-Way ball valve type 543
Horizontal/L-port
With butt fusion spigots long
PE100 SDR11 metric

Model:

- Material: PP-H/PE
- For easy installation and removal (valve end and union nut are compatible with type 546)
- Ball seals PTFE
- Pneumatic or electric actuator available separately
- Angle of operation 360° without turn limiter
- Turn limiter 90° enclosed, in different positions usable as a clip-on ring
- Integrated stainless steel mounting inserts
- Delivery status A-C opened, see flow scheme

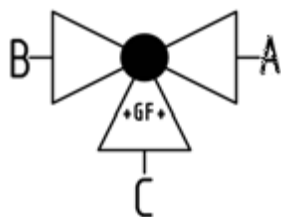

d (mm)	DN (mm)	PN (bar)	kv-value (Δp=1 bar) (l/min)	EPDM Code	Weight (kg)	FPM Code	Weight (kg)
20	15	10	75	167 543 122	0.179	167 543 132	0.179
25	20	10	150	167 543 123	0.262	167 543 133	0.262
32	25	10	280	167 543 124	0.399	167 543 134	0.399
40	32	10	480	167 543 125	0.675	167 543 135	0.675
50	40	10	620	167 543 126	1.032	167 543 136	1.032
63	50	10	1230	167 543 127	2.125	167 543 137	2.221

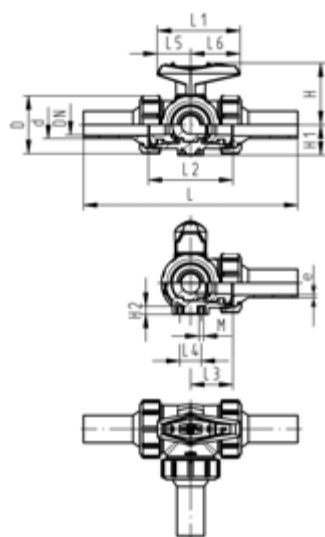

d (mm)	D (mm)	L (mm)	L1 (mm)	L2 (mm)	L3 (mm)	L4 (mm)	L5 (mm)	L6 (mm)	H (mm)	H1 (mm)	H2 (mm)	M	e (mm)	closest inch (inch)
20	50	210	77	72	36	25	32	45	57	28	8	6	2.3	1/2
25	58	237	97	85	43	25	39	58	67	32	8	6	2.3	3/4
32	68	250	97	98	49	25	39	58	73	36	8	6	2.9	1
40	84	282	128	118	59	45	54	74	90	45	9	8	3.7	1 1/4
50	97	317	128	135	68	45	54	74	97	51	9	8	4.6	1 1/2
63	124	396	152	176	88	45	66	87	116	65	9	8	5.8	2

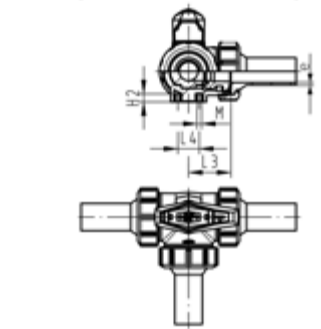
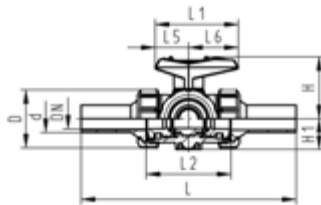
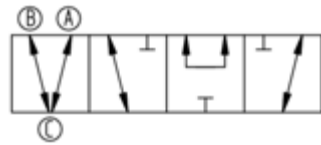
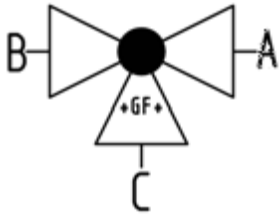

ecoFIT
3-Way ball valve type 543
Horizontal/T-port
With butt fusion spigots long
PE100 SDR11 metric

Model:

- Material: PP-H/PE
- For easy installation and removal (valve end and union nut are compatible with type 546)
- Ball seals PTFE
- Pneumatic or electric actuator available separately
- Angle of operation 360° without turn limiter
- Turn limiter 90° enclosed, in different positions usable as a clip-on ring
- Integrated stainless steel mounting inserts
- Delivery status A-B opened, see flow scheme

d	DN	PN	kv-value	EPDM	Weight	FPM	Weight
(mm)	(mm)	(bar)	($\Delta p=1$ bar)	Code	(kg)	Code	(kg)
			(l/min)				
20	15	10	200	167 543 322	0.179	167 543 332	0.179
25	20	10	470	167 543 323	0.261	167 543 333	0.261
32	25	10	793	167 543 324	0.395	167 543 334	0.395
40	32	10	1290	167 543 325	0.668	167 543 335	0.668
50	40	10	1910	167 543 326	1.019	167 543 336	1.019
63	50	10	3100	167 543 327	2.192	167 543 337	2.192

d	D	L	L1	L2	L3	L4	L5	L6	H	H1	H2	M	e	closest
(mm)	(mm)	(mm)	(mm)	(mm)	(mm)	(mm)	(mm)	(mm)	(mm)	(mm)	(mm)	(mm)	(mm)	inch
														(inch)
20	50	210	77	72	36	25	32	45	57	28	8	6	2.3	½
25	58	237	97	85	43	25	39	58	67	32	8	6	2.3	¾
32	68	250	97	98	49	25	39	58	73	36	8	6	2.9	1
40	84	282	128	118	59	45	54	74	90	45	9	8	3.7	1 ¼
50	97	317	128	135	68	45	54	74	97	51	9	8	4.6	1 ½
63	124	396	152	176	88	45	66	87	116	65	9	8	5.8	2

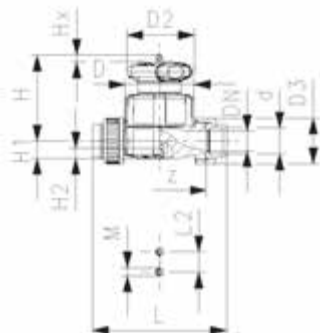

ecoFIT
Diaphragm valve type 514
With fusion sockets PE80 metric

Model:

- Material: PP-H/PE
- Double flow rate compared to predecessor
- One housing nut replaces four screws
- Handwheel with built-in locking mechanism
- For easy installation and removal
- Short overall length

Option:

- Individual configuration of the valve (see diagram)
- Self adjusting multifunctional module with integrated limit switches

d (mm)	DN (mm)	PN (bar)	kv-value ($\Delta p=1$ bar) (l/min)	EPDM Code	Weight (kg)	PTFE/EPDM Code	Weight (kg)
20	15	10	125	167 514 212	0.263	167 514 232	0.371
25	20	10	271	167 514 213	0.490	167 514 233	0.502
32	25	10	481	167 514 214	1.083	167 514 234	1.103
40	32	10	759	167 514 215	1.279	167 514 235	1.299
50	40	10	1263	167 514 216	2.259	167 514 236	2.289
63	50	10	1728	167 514 217	2.950	167 514 237	2.978

d (mm)	D (mm)	D2 (mm)	D3 (mm)	L (mm)	L2 (mm)	H (mm)	H1 (mm)	H2 (mm)	M	z (mm)	Lift = Hx (mm)	closest inch (inch)
20	65	65	48	128	25	73	14	12	M6	100	7	½
25	80	65	58	150	25	81	18	12	M6	118	10	¾
32	88	87	65	162	25	107	22	12	M6	126	13	1
40	101	87	79	184	45	115	26	15	M8	144	15	1 ¼
50	117	135	91	210	45	148	32	15	M8	164	19	1 ½
63	144	135	111	248	45	166	39	15	M8	194	25	2

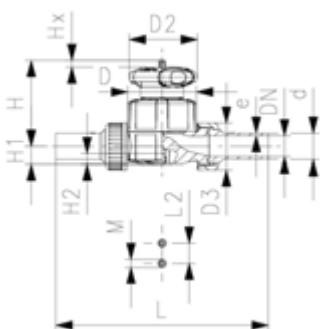

ecoFIT
Diaphragm valve type 514
With butt and electro fusion ends PE100 SDR11 metric

Model:

- Material: PP-H/PE
- Double flow rate compared to predecessor
- One housing nut replaces four screws
- Handwheel with built-in locking mechanism
- For easy installation and removal
- Short overall length

Option:

- Individual configuration of the valve (see diagram)
- Self adjusting multifunctional module with integrated limit switches

d (mm)	DN (mm)	PN (bar)	kv-value ($\Delta p=1$ bar) (l/min)	EPDM Code	Weight (kg)	PTFE/EPDM Code	Weight (kg)
20	15	10	125	167 514 312	0.372	167 514 332	0.381
25	20	10	271	167 514 313	0.502	167 514 333	0.514
32	25	10	481	167 514 314	0.636	167 514 334	1.127
40	32	10	759	167 514 315	0.950	167 514 335	1.337
50	40	10	1263	167 514 316	2.329	167 514 336	2.359
63	50	10	1728	167 514 317	2.167	167 514 337	3.088

table continued on the next page

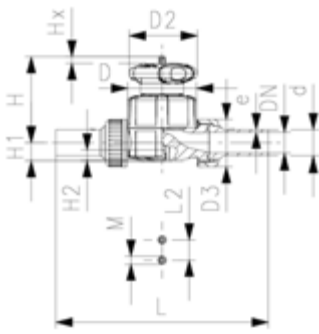

d (mm)	D (mm)	D2 (mm)	D3 (mm)	L (mm)	L2 (mm)	H (mm)	H1 (mm)	H2 (mm)	M	Lift = Hx (mm)	e (mm)	closest inch (inch)
20	65	65	48	196	25	73	14	12	M6	7	1.9	½
25	80	65	58	221	25	81	18	12	M6	10	2.3	¾
32	88	87	65	234	25	107	22	12	M6	13	2.9	1
40	101	87	79	260	45	115	26	15	M8	15	3.7	1 ¼
50	117	135	91	284	45	148	32	15	M8	19	4.6	1 ½
63	144	135	111	321	45	166	39	15	M8	25	5.8	2



PROGEF Standard
Butterfly valve type 567
Hand lever with ratchet settings

Model:

- Material: PP-H, DN350-DN600 material PP-R
- Up to DN 300: Overall length according to EN558 (DN 50-200: line 25, DN250, 300 line 16), ISO 5752
- Connecting dimension: ISO 7005 PN 10, EN 1092 PN 10, DIN 2501 PN 10, ANSI/ASME B 16.5 Class 150, BS 1560: 1989, BS 4504, JIS B 2220
- We recommend for the dimensions DN250 and DN300 only 6 bar maximum system pressure for the hand lever version

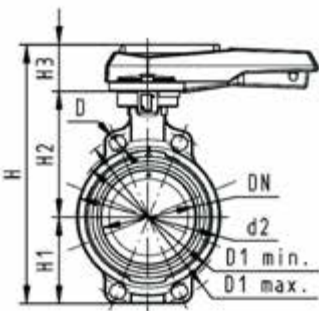

d (mm)	Size (inch)	DN (mm)	PN (bar)	kv-value ($\Delta p=1$ bar) (l/min)	EPDM Code	Weight (kg)	FPM Code	Weight (kg)
63	2	50	10	1470	167 567 002	1.170	167 567 022	1.627
75	2 ½	65	10	2200	167 567 003	1.254	167 567 023	1.061
90	3	80	10	3000	167 567 004	1.384	167 567 024	1.404
110	4	100	10	6500	167 567 005	1.961	167 567 025	1.998
140	5	125	10	11500	167 567 006	2.367	167 567 026	2.429
160	6	150	10	16600	167 567 007	3.741	167 567 027	3.246
225	8	200	10	39600	167 567 008	5.545	167 567 028	5.609
280	10	250	8	55200	167 567 009	11.061	167 567 029	11.841
315	12	300	8	80000	167 567 010	16.548	167 567 030	13.245

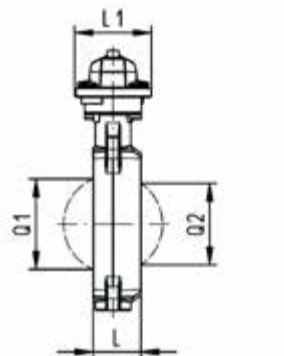

d (mm)	PTFE Code	Weight (kg)
63	167 567 202	1.170
75	167 567 203	1.254
90	167 567 204	1.384
110	167 567 205	1.961
140	167 567 206	2.367
160	167 567 207	3.741
225	167 567 208	5.545
280	167 567 209	11.061
315	167 567 210	16.548

d (mm)	d2 (mm)	D (mm)	D1 min. (mm)	D1 max. (mm)	H (mm)	H1 (mm)	H2 (mm)	H3 (mm)	L (mm)	L1 (mm)	L2 (mm)	Q1 (mm)	Q2 (mm)
63	104	19	120	125	264	77	134	54	45	106	205	40	
75	115	19	140	145	277	83	140	54	46	106	205	54	35
90	131	19	150	160	289	89	146	54	49	106	205	67	50
110	161	19	175	191	325	104	167	55	56	106	255	88	74
140	187	23	210	216	352	117	181	55	64	106	255	113	97

table continued on the next page

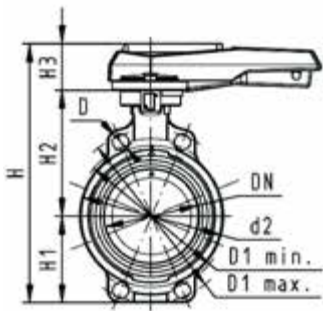

d (mm)	d2 (mm)	D (mm)	D1 min. (mm)	D1 max. (mm)	H (mm)	H1 (mm)	H2 (mm)	H3 (mm)	L (mm)	L1 (mm)	L2 (mm)	Q1 (mm)	Q2 (mm)
160	215	24	241	241	373	130	189	55	72	106	255	139	123
225	267	23	290	295	435	158	210	67	73	140	408	178	169
280	329	25	353	362	554	205	264	85	113	149	408	210	207
315	379	25	400	432	598	228	285	85	113	149	408	256	253

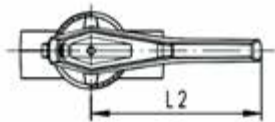
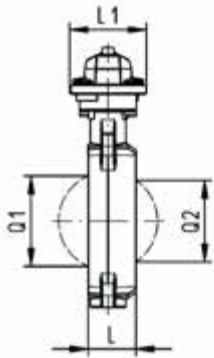



PROGEF Standard
Lugstyle butterfly valve type 578
Hand lever with ratchet settings

Model:

- Housing material: PP-GF30 with SS316 lug-inserts
- Overall length according to EN 558, ISO 5752 (DN50 - 200 line 25, DN250 - 300 line 10)
- Connecting dimension: ISO 7005 PN10, EN 1092 PN10, DIN 2501 PN10
- We recommend for the dimensions DN250 and DN300 only 6 bar maximum system pressure for the hand lever version

Option:

- Optional accessory: Valve-Integrated position feedback with limit switches (limit switches have to be ordered separately)

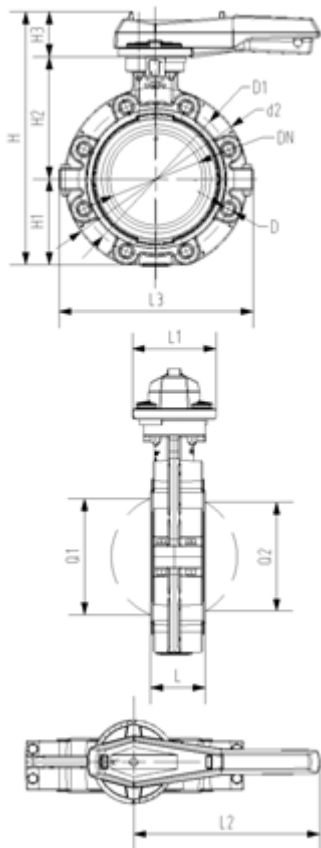

d	Size	DN	PN	kv-value	EPDM	Weight	FPM	Weight
(mm)	(inch)	(mm)	(bar)	($\Delta p=1$ bar)	Code	(kg)	Code	(kg)
				(l/min)				
63	2	50	10	1470	167 578 002	1.800	167 578 022	1.800
75	2 ½	65	10	2200	167 578 003	1.895	167 578 023	1.895
90	3	80	10	3000	167 578 004	2.251	167 578 024	2.251
110	4	100	10	6500	167 578 005	3.146	167 578 025	3.146
140	5	125	10	11500	167 578 006	4.660	167 578 026	4.660
160	6	150	10	16600	167 578 007	6.430	167 578 027	6.430
225	8	200	10	39600	167 578 008	8.625	167 578 028	8.625
280	10	250	8	55200	167 578 009	19.528	167 578 029	19.528
315	12	300	8	80000	167 578 010	26.106	167 578 030	26.106

d	d2	D	D1	H	H1	H2	H3	L	L1	L2	L3	Q1	Q2
(mm)	(mm)	(mm)	(mm)	(mm)	(mm)	(mm)	(mm)	(mm)	(mm)	(mm)	(mm)	(mm)	(mm)
63	160	M16	125	265	77	134	54	45	106	205	150	40	
75	180	M16	145	277	83	140	54	46	106	205	182	54	35
90	195	M16	160	289	89	146	54	49	106	205	210	67	50
110	226	M16	180	328	106	167	55	56	106	255	240	88	74
140	258	M16	210	357	121	181	55	64	106	255	272	113	97
160	284	M20	240	377	133	189	55	72	106	255	297	139	123
225	341	M20	295	436	159	210	67	73	140	408	360	178	169
280	412	M20	350	536	205	264	67	113	140	408	440	210	207
315	482	M20	400	586	234	285	67	113	140	408	510	256	253



ecoFIT
Check valve type 561
With butt fusion spigots long
PE100 SDR11 metric

Model:

- Material: PP-H/PE
- For vertical installation
- Ball is sealing at a minimum water column of 2 m
- Designed for easy installation and removal
- Vibration free even at high flow velocity
- Flow-optimized return cone, double guided
- Compact installation length, same as ball valve type 546
- Z-length, end connectors and union nuts **not** compatible with type 360

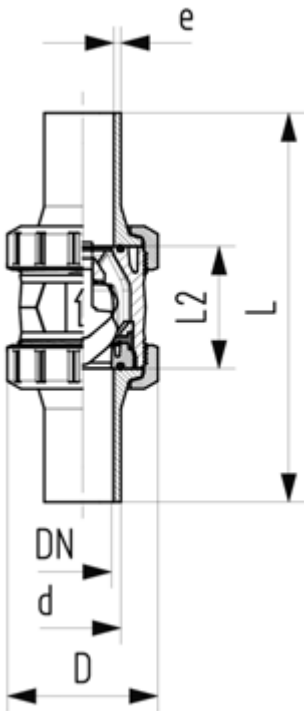

d (mm)	DN (mm)	PN (bar)	kv-value ($\Delta p=1$ bar) (l/min)	EPDM Code	Weight (kg)	FPM Code	Weight (kg)
20	15	10	180	167 561 282	0.090	167 561 292	0.090
25	20	10	380	167 561 283	0.190	167 561 293	0.200
32	25	10	460	167 561 284	0.210	167 561 294	0.220
40	32	10	850	167 561 285	0.380	167 561 295	0.380
50	40	10	1080	167 561 286	0.560	167 561 296	0.570
63	50	10	1670	167 561 287	1.050	167 561 297	1.060
75	65	10	2950	167 561 288	2.420		
90	80	10	3600	167 561 289	3.680		
110	100	10	4150	167 561 290	6.240		

d (mm)	D (mm)	L (mm)	L2 (mm)	e (mm)	closest inch (inch)
20	50	193	56	2.3	½
25	58	216	65	2.3	¾
32	68	223	71	3.0	1
40	84	249	85	3.7	1 ¼
50	97	271	89	4.6	1 ½
63	124	321	101	5.8	2
75	166	386	136	6.8	2 ½
90	200	421	141	8.2	3
110	238	484	164	10.0	4



ecoFIT
Check valve type 561
With butt fusion spigots
PE100 SDR17,6 metric

Model:

- Material: PP-H/PE
- For vertical installation
- Designed for easy installation and removal
- Vibration free even at high flow velocity
- Flow-optimized return cone, double guided
- Compact installation length, same as ball valve type 546
- Z-length, end connectors and union nuts **not** compatible with type 360

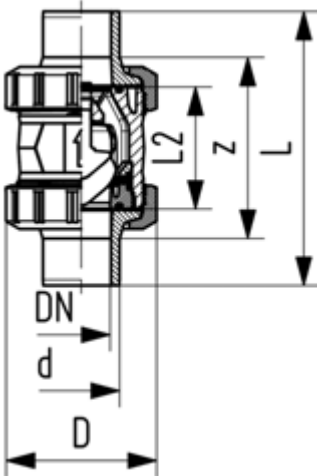

d (mm)	DN (mm)	PN (bar)	kv-value ($\Delta p=1$ bar) (L/min)	EPDM Code	Weight (kg)	FPM Code	Weight (kg)
50	40	10	1080	167 561 266	0.510	167 561 276	0.510
63	50	10	1670	167 561 267	0.940	167 561 277	0.940

d (mm)	D (mm)	L (mm)	L2 (mm)	e (mm)	closest inch (inch)
50	97	191	89	3	1 ½
63	124	220	101	4	2



ecoFIT
Check valve type 562
With butt fusion spigots long
PE100 SDR11 metric

Model:

- Material: PP-H/PE
- For horizontal or vertical installation
- Spring loaded, spring made of stainless steel (1.4310)
- Spring available in other materials, see spare parts
- Designed for easy installation and removal
- Vibration free even at high flow velocity
- Flow-optimized return cone, double guided
- Compact installation length, same as ball valve type 546
- Z-length, end connectors and union nuts **not** compatible with type 360

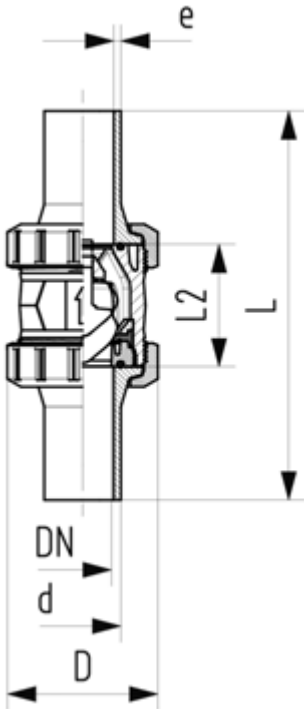

d (mm)	DN (mm)	PN (bar)	kv-value ($\Delta p=1$ bar) (L/min)	EPDM Code	Weight (kg)	FPM Code	Weight (kg)
20	15	10	180	167 562 282	0.090	167 562 292	0.090
25	20	10	380	167 562 283	0.190	167 562 293	0.200
32	25	10	460	167 562 284	0.210	167 562 294	0.220
40	32	10	850	167 562 285	0.380	167 562 295	0.380
50	40	10	1080	167 562 286	0.560	167 562 296	0.570
63	50	10	1670	167 562 287	1.050	167 562 297	1.060

d (mm)	D (mm)	L (mm)	L2 (mm)	e (mm)	closest inch (inch)
20	50	193	56	2.3	½
25	58	216	65	2.3	¾
32	68	223	71	3.0	1
40	84	249	85	3.7	1 ¼
50	97	271	89	4.6	1 ½
63	124	321	101	5.8	2



ecoFIT
Check valve type 562
With butt fusion spigots
PE100 SDR17,6 metric

Model:

- Material: PP-H/PE
- For horizontal or vertical installation
- Spring loaded, spring made of stainless steel (1.4310)
- Spring available in other materials, see spare parts
- Designed for easy installation and removal
- Vibration free even at high flow velocity
- Flow-optimized return cone, double guided
- Compact installation length, same as ball valve type 546
- Z-length, end connectors and union nuts **not** compatible with type 360

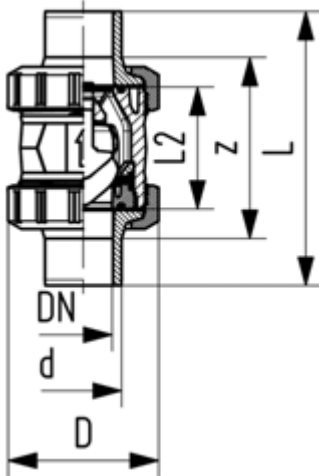

d (mm)	DN (mm)	PN (bar)	kv-value ($\Delta p=1$ bar) (l/min)	EPDM Code	Weight (kg)	FPM Code	Weight (kg)
50	40	10	1080	167 562 266	0.510	167 562 276	0.510
63	50	10	1670	167 562 267	0.940	167 562 277	0.940

d (mm)	D (mm)	L (mm)	L2 (mm)	e (mm)	closest inch (inch)
50	97	191	89	3	1 ½
63	124	220	101	4	2

Valve ends

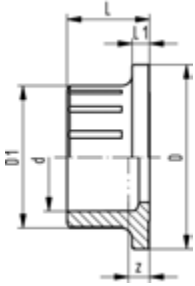

ecoFIT Valve end 546 and 543 (G40) With fusion socket metric

Model:

- Material: PE100

d (mm)	PN (bar)	Code	Weight (kg)	D (mm)	D1 (mm)	L (mm)	L1 (mm)	z (mm)
16	16	193 480 175	0.007	38	23	19	4	5
20	16	193 480 176	0.007	38	27	20	4	5
25	16	193 480 177	0.012	44	33	22	5	6
32	16	193 480 178	0.017	53	41	24	5	6
40	16	193 480 179	0.026	65	51	26	5	7
50	16	193 480 180	0.042	77	62	29	6	8
63	16	193 480 181	0.075	99	77	34	7	8

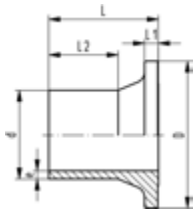

ecoFIT Valve end 546 and 543 (G41) With butt fusion spigot IR-Plus® SDR11 metric

Model:

- Material: PE100

d (mm)	FM	PN (bar)	Code	Weight (kg)	D (mm)	L (mm)	L1 (mm)	L2 (mm)	e (mm)
20	IR	16	193 480 102	0.008	38	37	4	25	1.9
25	IR	16	193 480 103	0.013	44	39	5	25	2.3
32	IR	16	193 480 104	0.019	53	40	5	25	2.9
40	IR	16	193 480 105	0.030	65	43	5	25	3.7
50	IR	16	193 480 106	0.054	77	51	6	25	4.6
63	IR	16	193 480 107	0.096	99	60	7	28	5.8

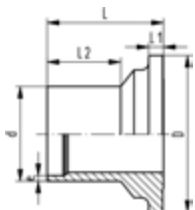

ecoFIT Valve end 546 and 543 (G42) With butt fusion spigot IR-Plus® SDR17.6 metric

Model:

- Material: PE100

d (mm)	FM	PN (bar)	Code	Weight (kg)	D (mm)	L (mm)	L1 (mm)	L2 (mm)	e (mm)
40	IR	10	193 480 086	0.030	65	43	5	25	2.3
50	IR	10	193 480 087	0.053	77	51	6	25	2.9
63	IR	10	193 480 088	0.096	99	60	7	28	3.6

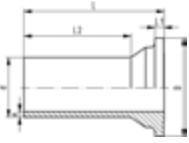

ecoFIT
Valve end 546 and 543 (G43)
With butt fusion spigot long SDR11 metric

Model:

- Material: PE100

d (mm)	PN (bar)	Code	Weight (kg)	D (mm)	L (mm)	L1 (mm)	L2 (mm)	e (mm)
20	16	193 480 152	0.013	38	69	4	53	2.2
25	16	193 480 153	0.023	44	76	5	58	2.3
32	16	193 480 154	0.032	53	76	5	58	2.9
40	16	193 480 155	0.054	65	82	5	61	3.7
50	16	193 480 156	0.086	77	91	6	63	4.6
63	16	193 480 157	0.165	99	110	7	77	5.8
75	16	193 480 158	0.280	125	125	9	89	6.8
90	16	193 480 159	0.447	150	140	10	103	8.2
110	16	193 480 160	0.731	180	160	11	117	10.0

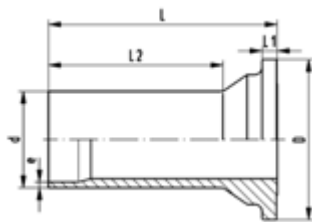

ecoFIT
Valve end 546 and 543 (G44)
With butt fusion spigot long SDR17,6 metric

Model:

- Material: PE100

d (mm)	PN (bar)	Code	Weight (kg)	D (mm)	L (mm)	L1 (mm)	L2 (mm)	e (mm)
75	16	193 480 168	0.260	125	125	9	89	4.3
90	16	193 480 169	0.415	150	140	10	103	5.1
110	16	193 480 170	0.683	180	160	11	117	6.3

Valve Finder

GF Valve Finder is a new online tool which helps you and your customers to find the right valve in a quick and convenient way. GF Valve Finder offers three selection criteria: type of valve, type of actuation and/or type of material. The tool guides the customer through the selection process. Option where GF Piping Systems has no offerings in the standard portfolio (e.g. electric actuated diaphragm valves) will be greyed out. By selecting at least one of the options GF Valve Finder will guide our customers directly to a page with matching valves. On this page customers can use the extended search (see left side of result page) and narrow down the results even more.

Have a look on our website and give it a try!

www.gfps.com/gfvalvefinder

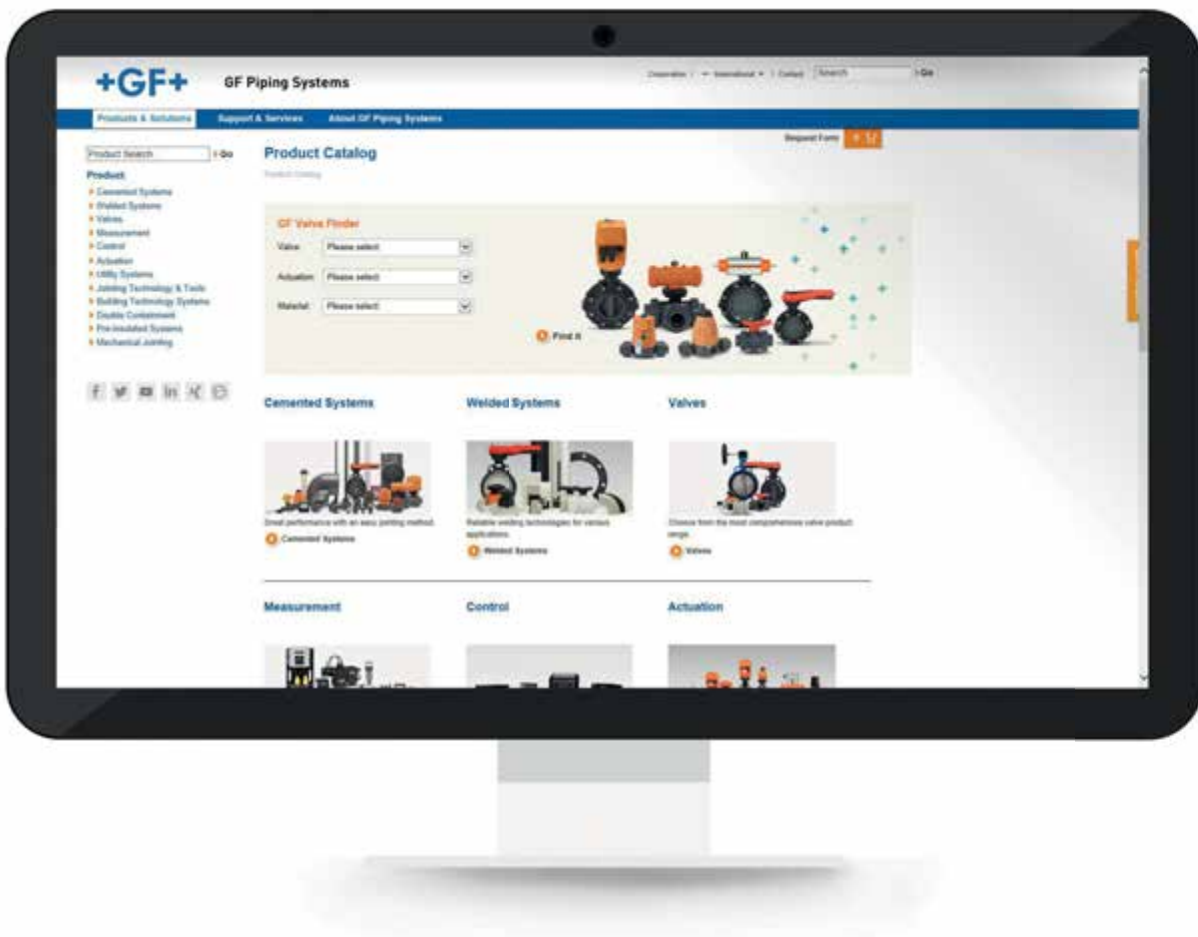

Flanged Connections

The right size for every challenge



Table of contents

Flange adaptor long end	174
Flange adaptor short end	177
Flanges for butt fusion systems	184
Flange adaptor socket fusion systems	191
Flanges for socket fusion systems	193
Gaskets	195

Flange adaptor long end

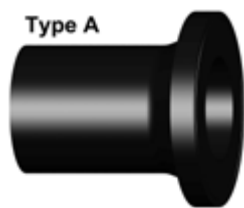

Type B

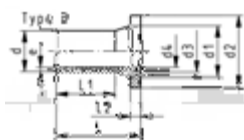
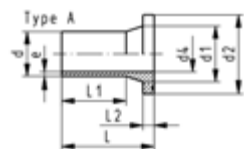
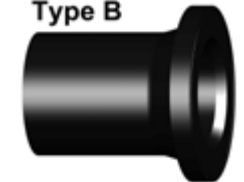

Flange adaptor PE100 SDR11 Combined jointing face: flat and serrated

Model:

- Long spigot
 - Material: PE100
 - For IR, butt- and electro fusion
 - Suitable for flange connections to metric (from d110 also to ANSI/ASME B16.5)
 - Up to d280, suitable for butterfly valve type 037/038/039. Above use ecoFIT adaptor for butterfly valves SDR11 (d315-d800)
 - Up to d315, suitable for butterfly valve type 567/578 and 038/039. Above use ecoFIT adaptor for butterfly valves SDR11 (d355-d800)
 - Gasket d20-d630: Profile flange gasket NBR No. 45 44 07, EPDM No. 48 44 07
 - Gasket d710-d1000: flat gasket EPDM No. 48 40 03
 - Type A without chamfer, Type B with chamfer
 - 10 bar Gas / 16 bar Water
- * Not suitable for butterfly valves type 037/038/039
** Not suitable for butterfly valves

d (mm)	DN (mm)	FM	Code	Weight (kg)
20	15	IR	753 800 006	0.022
25	20	IR	753 800 007	0.037
32	25	IR	753 800 008	0.056
40	32	IR	753 800 009	0.081
50	40	IR	753 800 010	0.119
63	50	IR	753 800 011	0.187
75	65	IR	753 800 012	0.314
90	80	IR	753 800 013	0.471
110	100	IR	753 800 014	0.706
125	100	IR	753 800 015	0.883
140	125	IR	753 800 016	1.348
160	150	IR	753 800 017	1.718
180	150	IR	753 800 018	2.035
200	200	IR	753 800 019	2.899
225	200	IR	753 800 020	3.208
250	250		753 800 021	4.878
280	250		753 800 022	4.925
*	315	300	753 800 023	7.135
	355	350	753 800 224	10.400
	400	400	753 800 225	14.500
	450	500	753 800 226	23.700
	500	500	753 800 227	27.100
**	560	600	753 800 028	40.000
**	630	600	753 800 029	42.300
**	710	700	753 800 030	56.379
**	800	800	753 800 033	72.636

d (mm)	DN (mm)	d1 (mm)	d2 (mm)	d3 (mm)	d4 (mm)	L (mm)	L1 (mm)	L2 (mm)	e (mm)	Type
20	15	27	45		16	85.0	41.0	7	1.9	A
25	20	33	58		20	90.5	62.0	9	2.3	A
32	25	40	68		26	91.5	61.0	10	3.0	A
40	32	50	78		32	94.5	61.5	11	3.7	A
50	40	61	88		40	90.0	62.0	12	4.6	A
63	50	75	102		51	98.0	69.0	14	5.8	A
75	65	89	122	66	61	125.0	89.0	16	6.8	B
90	80	105	138	78	73	140.0	103.0	17	8.2	B
110	100	125	158	100	90	160.0	114.0	18	10.0	B
125	100	132	158	114	102	170.0	125.0	25	11.4	B
140	125	155	188	127	114	200.0	147.0	25	12.7	B
160	150	175	212	151	130	200.0	147.0	25	14.6	B
180	150	180	212	158	147	200.0	170.0	30	16.4	B

table continued on the next page

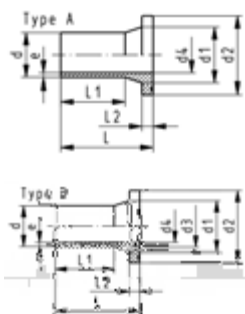

	d	DN	d1	d2	d3	d4	L	L1	L2	e	Type
	(mm)	(mm)	(mm)	(mm)	(mm)	(mm)	(mm)	(mm)	(mm)	(mm)	
	200	200	232	268	203	163	200.0	128.0	32	18.2	B
	225	200	235	268	210	184	200.0	138.0	32	20.5	B
	250	250	285	320	252	202	220.0	129.0	35	22.7	B
	280	250	291	320	265	229	231.0	144.0	35	25.4	B
*	315	300	335	370	300	257	239.0	158.0	35	28.6	B
	355	350	373	430	342	284	267.0	170.0	40	32.0	B
	400	400	427	482	387	320	292.0	185.0	46	36.0	B
	450	500	514	585	400	360	330.0	205.0	60	41.0	B
	500	500	530	585	442	400	351.0	220.0	60	46.0	B
**	560	600	615	685	490	458	365.0	230.0	60	50.9	B
**	630	600	642	685	545	515	385.0	250.0	60	57.3	B
**	710	700	737	800		581	400.0	280.0	60	64.5	A
**	800	800	840	905		652	400.0	280.0	65	74.0	A

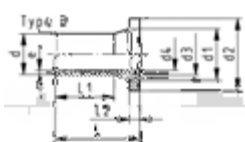
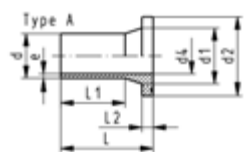
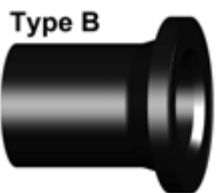
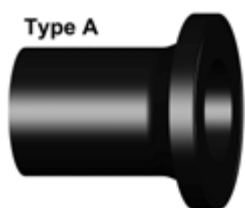

Flange adaptor PE100 SDR17/17.6 Combined jointing face: flat and serrated

Model:

- Material: PE100
 - Long spigot
 - For IR, butt- and electro fusion
 - Suitable for flange connections to metric (from d110 also to ANSI/ASME B16.5)
 - Up to d280, suitable for butterfly valve type 037/038/039. Above use ecoFIT adaptor for butterfly valves SDR17.6 (d315-d1200)
 - Up to d315, suitable for butterfly valve type 567/578. Above use ecoFIT adaptor for butterfly valves SDR17.6 (d355-d1200)
 - Gasket d20-d630: Profile flange gasket NBR No. 45 44 07, EPDM No. 48 44 07
 - Gasket d710-d1000: flat gasket EPDM No. 48 40 03
 - 5 bar Gas / 10 bar Water
 - Type A without chamfer, Type B with chamfer
- * Not suitable for butterfly valves type 037/038/039
** Not suitable for butterfly valves

d	DN	FM	Code	Weight
(mm)	(mm)			(kg)
50	40	IR	753 800 085	0.107
63	50	IR	753 800 086	0.168
75	65	IR	753 800 087	0.260
90	80	IR	753 800 088	0.367
110	100	IR	753 800 089	0.571
125	100	IR	753 800 090	0.684
140	125	IR	753 800 091	1.035
160	150	IR	753 800 092	1.342
180	150	IR	753 800 093	1.469
200	200	IR	753 800 094	2.297
225	200	IR	753 800 095	2.456
250	250		753 800 096	3.500
280	250		753 800 097	3.714
*	315	300	753 800 098	5.470
	355	350	753 800 299	7.100
	400	400	753 800 300	9.600
	450	500	753 800 301	16.400
	500	500	753 800 302	18.500
**	560	600	753 800 103	27.500
**	630	600	753 800 104	30.000
**	710	700	753 800 105	39.376
**	800	800	753 800 106	50.759
**	900	900	753 800 107	64.202
**	1000	1000	753 800 108	79.495

table continued on the next page

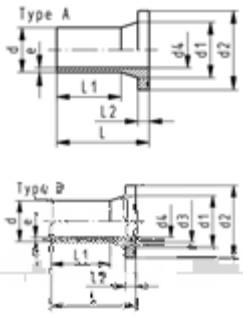

	d (mm)	d1 (mm)	d2 (mm)	d3 (mm)	d4 (mm)	L (mm)	L1 (mm)	L2 (mm)	e (mm)	Type
	50	61	88		44	90	62	12	3.0	A
	63	75	102		55	106	70	14	3.8	A
	75	89	122		66	130	75	16	4.5	A
	90	105	138		79	140	103	17	5.4	A
	110	125	158		96	160	117	18	6.6	A
	125	132	158	114	110	170	125	25	7.4	B
	140	155	188	127	123	200	147	25	8.3	B
	160	175	212	151	141	200	147	25	9.5	B
	180	180	212		158	200	170	30	10.7	A
	200	232	268	203	176	200	128	32	11.9	B
	225	235	268	210	198	200	138	32	13.4	B
	250	285	320	245	220	220	148	35	14.8	B
	280	291	320	265	246	230	154	35	16.6	B
*	315	335	370	300	277	242	166	36	18.7	B
	355	373	430	346	310	260	170	33	21.1	B
	400	427	482	395	350	282	185	36	23.7	B
	450	514	585	400	400	316	205	46	26.7	B
	500	530	585	442	400	337	220	46	29.7	B
**	560	615	685		493	365	230	60	33.2	A
**	630	642	685		555	385	250	60	37.4	A
**	710	737	800		626	400	280	50	42.1	A
**	800	840	905		705	400	280	52	47.4	A
**	900	944	1005		793	400	260	55	53.3	A
**	1000	1047	1110		881	400	260	60	59.3	A

Flange adaptor short end



ecoFIT flange adaptor SDR11 Jointing face combination serrated/flat metric

Model:

- Material: PE100
- Conventional butt-welding according to DVS 2207
- IR compatible
- Up to d315, suitable for butterfly valve type 567/578. Above use ecoFIT adaptor for butterfly valves SDR11 (d355-d800)
- Gasket d20-d630: Profile flange gasket NBR No. 45 44 07, EPDM No. 48 44 07
- Gasket d710-d1000: flat gasket EPDM No. 48 40 03

*Not suitable for butterfly valves

d (mm)	DN (mm)	FM	Code	Weight (kg)
20	15	IR	753 798 306	0.016
25	20	IR	753 798 307	0.034
32	25	IR	753 798 308	0.046
40	32	IR	753 798 309	0.067
50	40	IR	753 798 310	0.098
63	50	IR	753 798 311	0.157
75	65	IR	753 798 312	0.258
90	80	IR	753 798 313	0.347
110	100	IR	753 798 314	0.471
125	100	IR	753 798 315	0.517
140	125	IR	753 798 316	0.780
160	150	IR	753 798 317	0.973
180	150	IR	753 798 318	1.077
200	200	IR	753 798 319	1.734
225	200	IR	753 798 320	1.772
250	250		753 798 321	2.871
280	250		753 798 322	3.760
315	300		753 798 323	4.925
* 355	350		753 798 324	7.000
* 400	400		753 798 325	9.500
* 450	500		753 798 326	18.200
* 500	500		753 798 327	18.700
* 560	600		753 798 833	19.380
* 630	600		753 798 834	16.500
* 710	700		753 798 835	21.586
* 800	800		753 798 836	28.505

d (mm)	DN (mm)	d1 (mm)	d2 (mm)	d3 (mm)	d4 (mm)	L (mm)	L1 (mm)	L2 (mm)	e (mm)	Type
20	15	26	45		16	50	29	7	1.9	A
25	20	32	58		20	52	27	9	2.3	A
32	25	40	68		26	54	28	10	2.9	A
40	32	49	78		32	55	25	11	3.7	A
50	40	60	88		40	62	32	12	4.6	A
63	50	75	102		49	68	38	14	5.8	A
75	65	89	122	66	58	80	43	16	6.8	B
90	80	105	138	78	70	80	42	17	8.2	B
110	100	125	158	100	87	80	41	18	10.0	B
125	100	132	158	114	99	82	35	25	11.4	B
140	125	155	188	127	111	89	42	25	12.7	B
160	150	175	212	151	127	92	40	25	14.6	C
180	150	180	212	154	148	92	40	30	16.4	B
200	200	232	268	203	174	100	35	32	18.2	C
225	200	235	268	210	196	100	35	32	20.5	C
250	250	285	320	252	203	120	45	35	22.7	C
280	250	291	320	265	228	120	45	37	25.4	C
315	300	335	370	300	256	150	50	50	28.6	C

table continued on the next page

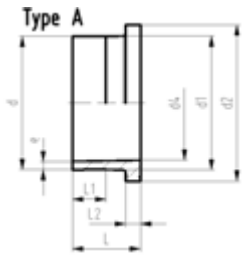

	d	DN	d1	d2	d3	d4	L	L1	L2	e	Type
	(mm)	(mm)	(mm)	(mm)	(mm)	(mm)	(mm)	(mm)	(mm)	(mm)	
*	355	350	373	430	342	284	162	70	40	32.2	C
*	400	400	427	482	387	320	172	70	46	36.3	C
*	450	500	514	585	400	360	225	105	60	40.9	C
*	500	500	530	585	442	400	231	105	60	45.4	C
*	560	600	615	684	490	458	135	20	60	50.8	B
*	630	600	642	684	545	516	135	40	60	57.2	B
*	710	700	737	800		581	120	20	60	64.5	A
*	800	800	840	905		655	120	18	65	72.6	A

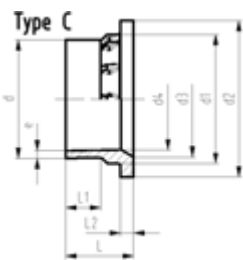
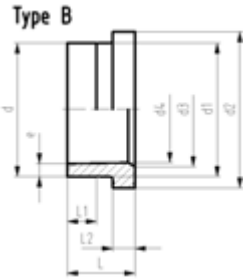

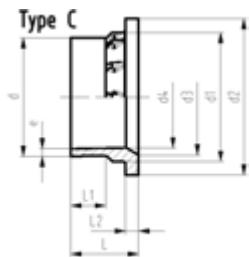
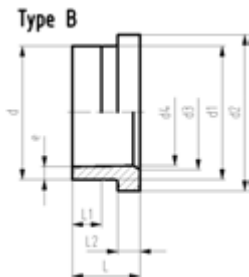
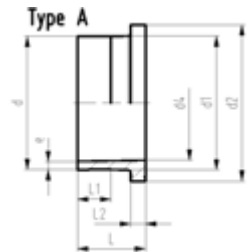

ecoFIT flange adaptor SDR17/17.6
Jointing face combination serrated/flat metric

Model:

- Material: PE100
- Conventional butt-welding according to DVS 2207
- IR compatible
- Up to d400, suitable for butterfly valve type 567/578 and 038/039. Above use ecoFIT adaptor for butterfly valves SDR17.6 (d450-d1200)
- Gasket d20-d630: Profile flange gasket NBR No. 45 44 07, EPDM No. 48 44 07
- Gasket d710-d1000: flat gasket EPDM No. 48 40 03
- * Not suitable for butterfly valves

d (mm)	DN (mm)	FM	Code	Weight (kg)
50	40	IR	753 798 210	0.093
63	50	IR	753 798 211	0.118
75	65	IR	753 798 212	0.220
90	80	IR	753 798 213	0.291
110	100	IR	753 798 214	0.389
125	100	IR	753 798 215	0.421
140	125	IR	753 798 216	0.648
160	150	IR	753 798 217	0.703
180	150	IR	753 798 218	0.739
200	200	IR	753 798 219	1.331
225	200	IR	753 798 220	1.304
250	250		753 798 221	2.272
280	250		753 798 222	2.154
315	300		753 798 223	3.819
355	350		753 798 224	4.800
400	400		753 798 225	6.400
* 450	500		753 798 226	12.700
* 500	500		753 798 227	13.000
* 560	600		753 798 858	14.875
* 630	600		753 798 859	12.515
* 710	700		753 798 860	15.878
* 800	800		753 798 861	20.948
* 900	900		753 798 862	29.183
* 1000	1000		753 798 863	36.209

d (mm)	DN (mm)	d1 (mm)	d2 (mm)	d3 (mm)	d4 (mm)	L (mm)	L1 (mm)	L2 (mm)	e (mm)	Type
50	40	60	88	-	44	62	32	12	2.9	A
63	50	75	102	-	55	68	38	14	3.8	A
75	65	89	122	-	63	80	43	16	4.5	A
90	80	105	138	-	76	80	42	17	5.4	A
110	100	125	158	-	94	80	42	18	6.6	A
125	100	132	158	114	110	82	35	25	7.4	B
140	125	155	188	127	123	89	39	25	8.3	B
160	150	175	212	158	138	92	47	18	9.5	C
180	150	180	212		158	92	45	20	10.7	A
200	200	232	268	203	174	100	42	24	11.9	C
225	200	235	268	210	196	100	42	24	13.4	C
250	250	285	320	252	221	120	45	25	14.8	C
280	250	291	320	265	247	120	45	35	16.6	C
315	300	335	370	300	278	150	50	50	18.7	C
355	350	373	430	346	310	155	70	33	21.1	C
400	400	427	482	395	350	162	70	36	23.7	C
* 450	500	514	585	400	400	211	105	46	26.7	C
* 500	500	530	585	446	442	217	105	46	29.7	C
* 560	600	615	685	430	493	142	60	50	33.2	B
* 630	600	642	685	545	555	144	71	50	37.4	B

table continued on the next page

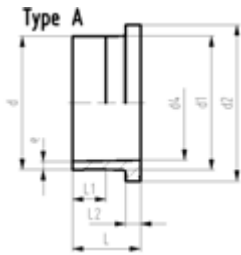

	d	DN	d1	d2	d3	d4	L	L1	L2	e	Type
	(mm)	(mm)	(mm)	(mm)	(mm)	(mm)	(mm)	(mm)	(mm)	(mm)	
*	710	700	737	800		626	120	20	50	42.1	A
*	800	800	840	905		705	120	18	52	47.4	A
*	900	900	944	1005		793	140	15	55	53.3	A
*	1000	1000	1047	1110		881	140	10	60	59.3	A

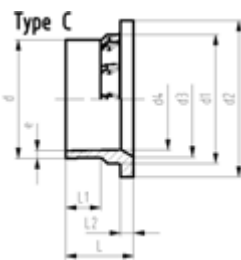
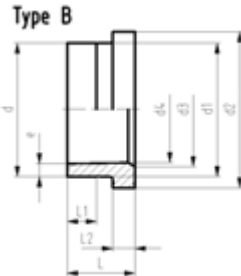

ecoFIT adaptor for butterfly valves SDR11 Jointing face flat metric

Model:

- Material: PE100
- Conventional butt-welding according to DVS 2207
- Suitable for butterfly valve type 567/578 and 038/039

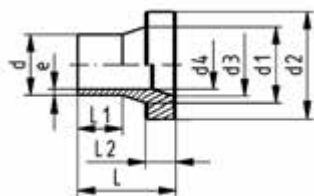

d	DN	Code	Weight	d1	d2	d3	d4	L	L1	L2	e
(mm)	(mm)		(kg)	(mm)	(mm)	(mm)	(mm)	(mm)	(mm)	(mm)	(mm)
355	350	753 798 924	8.400	373	430	350	284	187	70	65	33.9
400	400	753 798 925	11.000	427	482	400	320	196	70	70	38.2
450	500	753 798 926	18.800	467	533	450	360	272	105	107	43.0
500	500	753 798 927	19.900	530	585	498	400	261	105	90	47.8
560	600	753 798 728	29.270	615	685	610	458	282	60	147	50.8
630	600	753 798 729	23.042	642	685	610	515	210	60	132	57.2
710	700	753 798 730	33.765	737	800	701	581	215	20	155	64.5
800	800	753 798 731	41.787	840	905	785	655	194	18	140	72.6

ecoFIT adaptor for butterfly valves SDR17/17.6 Jointing face flat metric

Model:

- Material: PE100
- Conventional butt-welding according to DVS 2207
- Suitable for butterfly valve type 567/578 and 038/039

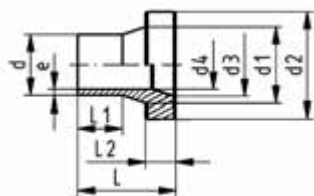

d	DN	Code	Weight	d1	d2	d3	d4	L	L1	L2	e
(mm)	(mm)		(kg)	(mm)	(mm)	(mm)	(mm)	(mm)	(mm)	(mm)	(mm)
450	500	753 798 951	10.700	467	533	397	397	224	105	59	27.5
500	500	753 798 952	12.100	530	585	440	440	217	105	46	30.5
560	600	753 798 753	17.307	615	685	610	493	227	60	92	33.2
630	600	753 798 754	12.122	642	685	610	555	149	60	71	37.4
710	700	753 798 755	21.505	737	800	701	625	175	20	105	42.1

table continued on the next page

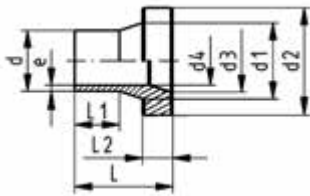

d (mm)	DN (mm)	Code	Weight (kg)	d1 (mm)	d2 (mm)	d3 (mm)	d4 (mm)	L (mm)	L1 (mm)	L2 (mm)	e (mm)
800	800	753 798 756	21.841	840	905	785	705	142	18	74	47.4
900	900	753 798 757	34.187	944	1005	890	793	189	15	104	53.3
1000	1000	753 798 758	43.733	1047	1110	994	881	204	10	124	59.3
1200	1200	753 798 759	106.295	1256	1330	1186	1057	377	160	126	71.2



ecoFIT outlet flange adaptor SDR11

Model:

- Material: PE80
- Suitable for wafer check valves Type 369
- Conventional butt-welding according to DVS 2207

Attention:

- In conjunction with outlet flange adaptors, **flange rings for socket systems** must be used.

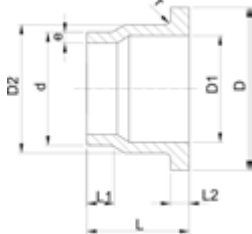

DN (mm)	d (mm)	Code	Weight (kg)	D (mm)	D1 (mm)	D2 (mm)	L (mm)	L1 (mm)	L2 (mm)	e (mm)	r (mm)
32	40	733 808 034	0.073	80	37	50	64	30	11	3.7	3
40	50	733 808 035	0.104	90	43	61	67	30	12	4.6	3
50	63	733 808 036	0.172	105	54	76	74	30	14	5.8	4
65	75	733 808 037	0.242	125	70	90	78	30	16	6.8	4
80	90	733 808 038	0.348	140	82	108	87	35	17	8.2	4
100	110	733 808 039	0.508	160	105	131	102	41	18	10.0	4
125	140	733 808 041	0.976	190	130	165	124	47	25	12.7	4
150	160	733 808 042	1.337	215	158	188	149	52	25	14.6	4
200	225	733 808 045	2.814	270	206	248	180	55	32	20.5	4
250	280	733 808 047	4.374	325	259	308	240	63	35	25.4	4
300	315	733 808 048	4.960	375	308	346	272	66	35	28.6	4



ecoFIT outlet flange adaptor SDR17.6

Model:

- Material: PE80
- Conventional butt-welding according to DVS 2207
- Suitable for wafer check valves Type 369

Attention:

- In conjunction with outlet flange adaptors, **flange rings for socket systems** must be used.

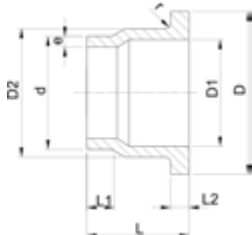

d (mm)	DN (mm)	Code	Weight (kg)	D (mm)	D1 (mm)	D2 (mm)	L (mm)	L1 (mm)	L2 (mm)	e (mm)	r (mm)
40	32	733 808 009	0.060	80	37	50	64	30	11	2.3	3
50	40	733 808 010	0.067	90	43	61	67	30	12	2.9	3
63	50	733 808 011	0.159	105	54	76	74	30	14	3.6	4
75	65	733 808 012	0.219	125	70	90	78	30	16	4.3	4
90	80	733 808 013	0.314	140	82	108	87	35	17	5.1	4
110	100	733 808 014	0.465	160	105	131	102	41	18	6.3	4
140	125	733 808 016	0.862	190	130	165	124	47	18	8.0	4
160	150	733 808 017	1.176	215	158	188	149	52	18	9.1	4
225	200	733 808 020	2.484	270	206	248	180	55	24	12.8	4
280	250	733 808 022	2.230	325	259	308	240	63	25	15.9	4
315	300	733 808 023	2.450	375	308	346	272	66	25	17.9	4

Component Parts for Flange Assembly, Typ 369 PP

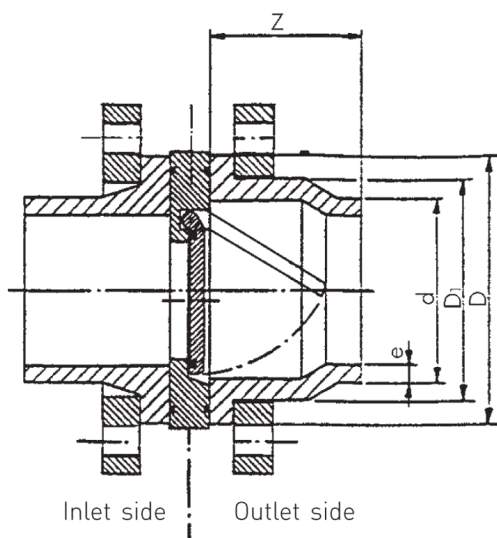

Warning: This outlet flange adaptor has to be installed on the outlet side!

Socket Fusion System PP/PE Inlet side

PP/PE
Flange adaptor
metric

d	DN	Inch	PP Code	PE Code					
40	32	1 1/4	727 790 209	753 790 209					
50	40	1 1/2	727 790 210	753 790 210					
63	50	2	727 790 211	753 790 211					
75	65	2 1/2	727 790 212	753 790 212					
90	80	3	727 790 213	753 790 213					
110	100	4	727 790 214	753 790 214					

Backing flange metric
for socket fusion systems
Connecting dimension
DIN 2501 PN 10

d	DN	Inch	for flange adaptor metric PP-V black	for flange adaptor metric PP with steel ring					
40	32	1 1/4	727 700 409	727 700 209					
50	40	1 1/2	727 700 410	727 700 210					
63	50	2	727 700 411	727 700 211					
75	65	2 1/2	727 700 412	727 700 212					
90	80	3	727 700 413	727 700 213					
110	100	4	727 700 414	727 700 214					

Outlet side

PP/PE
Outlet flange adaptor
with fusion socket
metric

d	DN	Inch	Joining face flat PP Code	Joining face flat PE Code	D	D ₁	Z		
40	32	1 1/4	727 800 009	733 800 009	61	50	35		
50	40	1 1/2	727 800 010	733 800 010	73	61	38		
63	50	2	727 800 011	733 800 011	90	76	41		
75	65	2 1/2	727 800 012	733 800 012	106	90	49		
90	80	3	727 800 013	733 800 013	125	108	65		
110	100	4	727 800 014	733 800 014	150	130	62		

Backing flange metric
for socket fusion systems
Connecting dimension
DIN 2501 PN 10

d	DN	Inch	for outlet flange adaptor PP-V black	for outlet flange adaptor PP with steel ring					
40	32	1 1/4	727 700 409	727 700 209					
50	40	1 1/2	727 700 410	727 700 210					
63	50	2	727 700 411	727 700 211					
75	65	2 1/2	727 700 412	727 700 212					
90	80	3	727 700 413	727 700 213					
110	100	4	727 700 414	727 700 214					

Component Parts for Flange Assembly, Type 369 PP

Butt Fusion System PP/PE

Inlet side

	d	DN	Inch	PP Code	PE Code				
	PP/PE Flange Adapter metric SDR 11	40	32	1¼	727 798 509	753 798 609			
	50	40	1½	727 798 510	753 798 610				
	63	50	2	727 798 511	753 798 611				
	75	65	2½	727 798 512	753 798 612				
	90	80	3	727 798 513	753 798 613				
	110	100	4	727 798 514	753 798 614				
	140	125	5	727 798 516	753 798 616				
	160	150	6	727 798 517	753 798 617				
	225	200	8	727 798 520	753 798 620				
	280	250	10	727 798 572	753 798 672				
	315	300	12	727 798 573	753 798 673				

	d	DN	Inch	PP Code	PE Code				
	PP/PE Flange Adapter metric SDR 17,6	40	32	1¼	--	--			
	50	40	1½	727 798 535	753 798 535				
	63	50	2	727 798 536	753 798 536				
	75	65	2½	727 798 412	753 798 512				
	90	80	3	727 798 413	753 798 513				
				727 798 414	753 798 514				
	110	100	4						
	140	125	5	727 798 541	753 798 541				
	160	150	6	727 798 542	753 798 542				
	225	200	8	727 798 545	753 798 545				
	280	250	10	727 798 547	753 798 547				
	315	300	12	727 798 548	753 798 548				

	d	DN	Inch	for Flange Adapter PP-V black	for Flange Adapter PP with steel ring				
	Backing flange metric for butt fusion systems	40	32	1¼	727 700 409	727 700 209			
Connecting dimension DIN 2501 PN 10	50	40	1½	727 700 410	727 700 210				
	63	50	2	727 700 411	727 700 211				
	75	65	2½	727 700 412	727 700 212				
	90	80	3	727 700 513	727 700 313				
	110	100	4	727 700 514	727 700 314				
	140	125	5	727 700 516	727 700 316				
	160	150	6	727 700 517	727 700 317				
	225	200	8	727 700 520	727 700 320				
	280	250	10	727 700 522	727 700 322				
	315	300	12	727 700 523	727 700 323				

Flanges for butt fusion systems

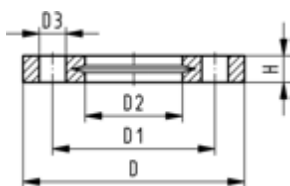

Backing flange PP-V metric For butt fusion systems metric

Model:

- Full-plastic flange PP-GF (30 % glass-fibre reinforced)
- Connecting dimension: ISO 7005, EN 1092, BS 4504, DIN 2501
- **Bolt circle PN 10**

AL: number of holes

¹⁾ Suitable for socket- and butt fusion systems

²⁾ Combined version, metric-ANSI

	d (mm)	DN (mm)	PN (bar)	Code	Weight (kg)	D (mm)	D1 (mm)	D2 (mm)	D3 (mm)	H (mm)	AL	SC
1	20	15	16	727 700 406	0.093	95	65	28	14	16	4	M12
1	25	20	16	727 700 407	0.120	105	75	34	14	17	4	M12
1	32	25	16	727 700 408	0.151	115	85	42	14	18	4	M12
1	40	32	16	727 700 409	0.244	140	100	51	18	20	4	M16
1	50	40	16	727 700 410	0.297	150	110	62	18	22	4	M16
1	63	50	16	727 700 411	0.362	165	125	78	18	24	4	M16
1	75	65	16	727 700 412	0.487	185	145	92	18	26	4	M16
	90	80	16	727 700 513	0.544	200	160	108	18	27	8	M16
	110	100	16	727 700 514	0.643	220	180	128	18	28	8	M16
	125	100	16	727 700 515	0.635	220	180	135	18	28	8	M16
	140	125	16	727 700 516	0.842	250	210	158	18	30	8	M16
2	160	150	16	727 700 517	1.200	285	240	178	22	32	8	M20
	180	150	16	727 700 518	1.200	285	240	188	22	32	8	M20
2	200	200	16	727 700 519	1.400	340	295	235	22	34	8	M20
2	225	200	16	727 700 520	1.400	340	295	238	22	34	8	M20
	250	250	16	727 700 521	2.052	395	350	288	22	38	12	M20
	280	250	16	727 700 522	1.700	395	350	294	22	38	12	M20
	315	300	16	727 700 523	2.400	445	400	338	22	42	12	M20
	355	350	10	727 700 524	4.440	515	460	376	22	46	16	M20
	400	400	10	727 700 525	5.624	574	515	430	26	50	16	M24

Backing flange PP-V Inch ANSI For butt fusion systems metric

Model:

- Full-plastic flange PP-GF (30 % glass-fibre reinforced)
- Connecting dimension: ANSI/ASME B 16.5 class 150, ASTM D 4024, BS 1560, BS EN 1759
- **Bolt circle class 150**
- Special flange adapter ANSI for d25 - d50 and d90 required

AL: number of holes

¹⁾ Suitable for socket- and butt fusion systems

²⁾ Combined version, metric-ANSI

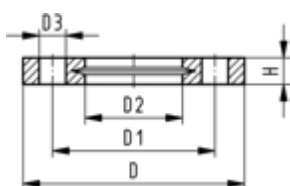

	Size (inch)	d (mm)	DN (mm)	PN (bar)	Code	Weight (kg)	D (mm)	D1 (mm)	D2 (mm)	D3 (mm)	H (mm)	AL	SC
1	½	20	15	16	727 701 406	0.091	95	60	28	16	16	4	M12
1	¾	25	20	16	727 701 407	0.120	105	70	34	16	17	4	M12
1	1	32	25	16	727 701 408	0.147	115	79	42	16	18	4	M12
1	1 ¼	40	32	16	727 701 409	0.246	140	89	51	16	20	4	M16
1	1 ½	50	40	16	727 701 410	0.299	150	98	62	16	22	4	M16
1	2	63	50	16	727 701 411	0.361	165	121	78	19	24	4	M16
1	2 ½	75	65	16	727 701 412	0.492	185	140	92	19	26	4	M16
	3	90	80	16	727 701 513	0.607	200	152	108	19	27	4	M16
	4	110	100	16	727 701 514	0.736	229	190	128	19	28	8	M16
2	6	160	150	16	727 700 517	1.200	285	240	178	22	32	8	M20
2	8	200	200	16	727 700 519	1.400	340	295	235	22	34	8	M20

table continued on the next page

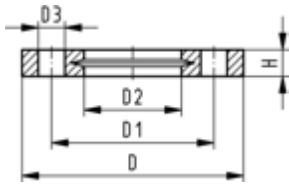

Size	d	DN	PN	Code	Weight	D	D1	D2	D3	H	AL	SC
(inch)	(mm)	(mm)	(bar)		(kg)	(mm)	(mm)	(mm)	(mm)	(mm)		
2	8	225	200	16	727 700 520	1.400	340	295	238	22	34	8 M20
	10	250	250	16	727 701 521	2.241	406	362	288	26	38	12 M20
	10	280	250	16	727 701 522	2.173	406	362	294	26	38	12 M20
	12	315	300	16	727 701 523	3.627	483	432	338	26	42	12 M20



Backing flange PP-Steel metric For butt fusion systems metric

Model:

- Material: PP (30% glass-fibre reinforced) with steel ring
- Connecting dimension: ISO 7005, EN 1092, BS 4504, DIN 2501
- **Bolt circle PN 10**

AL: number of holes

¹⁾ Suitable for socket -and butt fusion systems

²⁾ Combined version, bolt circle metric - ANSI

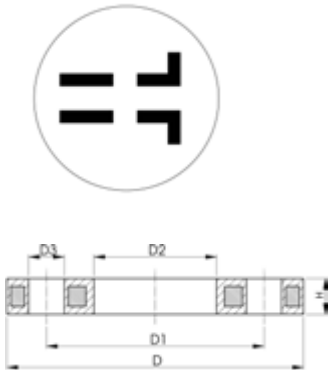

	d	DN	PN	Code	Weight	D	D1	D2	D3	H	AL	SC
	(mm)	(mm)	(bar)		(kg)	(mm)	(mm)	(mm)	(mm)	(mm)		
1	20	15	16	727 700 206	0.216	95	65	28	14	12	4	M12
1	25	20	16	727 700 207	0.279	105	75	34	14	12	4	M12
1	32	25	16	727 700 208	0.429	115	85	42	14	16	4	M12
1	40	32	16	727 700 209	0.621	140	100	51	18	16	4	M16
1	50	40	16	727 700 210	0.722	150	110	62	18	20	4	M16
1	63	50	16	727 700 211	1.084	165	125	78	18	20	4	M16
1	75	65	16	727 700 212	1.349	185	145	92	18	20	4	M16
	90	80	16	727 700 313	1.390	200	160	108	18	20	8	M16
	110	100	16	727 700 314	1.407	220	180	128	18	20	8	M16
	125	100	16	727 700 315	1.408	220	180	135	18	20	8	M16
	140	125	16	727 700 716	2.318	250	210	158	18	26	8	M16
2	160	150	16	727 700 717	3.491	285	241	178	22	26	8	M20
	180	150	16	727 700 718	3.108	285	241	188	22	26	8	M20
2	200	200	16	727 700 719	5.600	340	297	235	22	29	8	M20
2	225	200	16	727 700 720	5.533	340	297	238	22	29	8	M20
	250	250	16	727 700 721	6.632	395	350	288	22	32	12	M20
	280	250	16	727 700 722	6.573	395	350	294	22	32	12	M20
	315	300	16	727 700 723	7.903	445	400	338	22	36	12	M20
	355	350	16	727 700 724	14.587	515	460	376	23	42	16	M20
	400	400	16	727 700 725	20.034	574	515	430	26	42	16	M24



**Profiled backing flange PP-Steel metric
For butt fusion systems metric**

Model:

- PP with glass-fibre reinforcement and GGG 50 insert
- Connecting dimensions: ISO 7005, EN 1092, DIN 2501
- **Bolt circle PN 10**

Note:

flat side = bolt side profiled side = flange adaptor side

AL: number of holes

* Galvanized steel S235-JR, suitable for underground laying

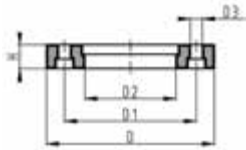

	d (mm)	DN (mm)	PN (bar)	Code	Weight (kg)	D (mm)	D1 (mm)	D2 (mm)	D3 (mm)	H (mm)	AL	SC
*	450	450	10	724 705 026	38.000	615	565	470	26	36	20	M24
	450	500	10	724 700 426	25.600	685	620	517	26	56	20	M24
	500	500	10	724 700 427	21.061	685	620	533	26	56	20	M24
	560	600	10	724 700 428	35.000	796	725	618	30	68	20	M27
	630	600	10	724 700 429	32.500	800	725	645	30	68	20	M27
	710	700	6	724 700 430	25.500	912	840	740	30	49	24	M27
	800	800	6	724 700 431	39.300	1026	950	843	33	58	24	M30
	900	900	6	724 700 432	48.500	1129	1050	947	33	62	28	M30



**Profiled backing flange PP-Steel metric
For butt fusion systems metric**

Model:

- PP with glass-fibre reinforcement and GGG 50 insert
- Connecting dimensions: ISO 7005, EN 1092, DIN 2501
- **Bolt circle PN 16**

Note:

flat side = bolt side profiled side = flange adaptor side

AL: number of holes

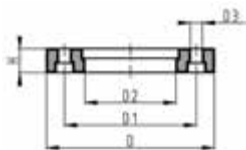

	d (mm)	DN (mm)	PN (bar)	Code	Weight (kg)	D (mm)	D1 (mm)	D2 (mm)	D3 (mm)	H (mm)	AL	SC
	200	200	16	724 700 319	3.549	344	295	235	22	31	12	M20
	225	200	16	724 700 320	3.380	344	295	238	22	31	12	M20
	250	250	16	724 700 321	6.390	410	355	288	26	35	12	M24
	280	250	16	724 700 322	6.310	410	355	294	26	36	12	M24
	315	300	16	724 700 323	9.740	455	410	338	26	43	12	M24
	355	350	16	724 700 324	15.203	521	470	376	26	55	16	M24
	400	400	16	724 700 325	20.600	582	525	430	30	56	16	M27



Backing flange PP-Steel Inch/ANSI For butt fusion systems metric

Model:

- Material: PP (30% glass-fibre reinforced) with steel ring
- Connecting dimension: ANSI/ASME B 16.5 class 150, ASTM D 4024, BS 1560, BS EN 1759
- **Bolt circle class 150**
- Special flange adapter ANSI for d25 - d50 and d90 required

¹⁾ Suitable for socket -and butt fusion systems

²⁾ Combined version, bolt circle metric - ANSI

AL: number of holes

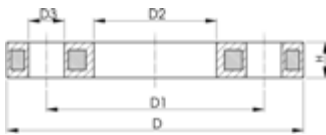

	d (inch)	d (mm)	DN (mm)	PN (bar)	Code	Weight (kg)	D (mm)	D1 (mm)	D2 (mm)	D3 (mm)	H (mm)	AL	SC
1	½	20	15	16	727 701 206	0.213	95	60	28	16	12	4	M12
1	¾	25	20	16	727 701 207	0.260	105	70	34	16	12	4	M12
1	1	32	25	16	727 701 208	0.416	115	79	42	16	16	4	M12
1	1 ¼	40	32	16	727 701 209	0.730	140	89	51	16	16	4	M16
1	1 ½	50	40	16	727 701 210	0.809	150	98	62	16	18	4	M16
1	2	63	50	16	727 701 211	0.866	165	121	78	19	18	4	M16
1	2 ½	75	65	16	727 701 212	1.117	185	140	92	19	18	4	M16
	3	90	80	16	727 701 313	1.499	200	152	108	19	20	4	M16
	4	110	100	16	727 701 314	1.739	229	190	128	19	20	8	M16
2	6	160	150	16	727 700 717	3.491	285	241	178	22	26	8	M20
2	8	200	200	16	727 700 719	5.600	340	297	235	22	29	8	M20
2	8	225	200	16	727 700 720	5.533	340	297	238	22	29	8	M20
	10	250/280	250	10	727 701 321	6.000	406	362	293	25	30	12	M24
	12	315	300	10	727 701 322	11.800	483	432	338	25	34	12	M24
	14	355	350	10	727 701 323	17.900	540	476	376	29	42	12	M27
	16	400	400	10	727 701 324	24.500	597	539	429	29	44	16	M27
	20	450/500	500	10	727 701 325	33.600	712	635	540	32	53	20	M30



Backing flange steel metric For butt fusion systems metric

Model:

- Material: S235JR / zinc-coated
- Connecting dimensions: ISO 7005, EN 1092, DIN 2501
- **Bolt circle PN 10**

AL: number of holes

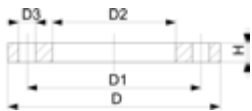

d (mm)	DN (mm)	PN (bar)	Code	Weight (kg)	D (mm)	D1 (mm)	D2 (mm)	D3 (mm)	H (mm)	AL	SC
200	200	10	701 474 383	7.400	340	295	235	22	20	8	M20
225	200	10	701 474 388	7.400	340	295	238	22	20	8	M20
250	250	10	701 474 399	9.090	395	350	288	22	22	12	M20
280	250	10	701 474 400	8.700	395	350	294	22	22	12	M20
315	300	10	701 474 401	12.200	445	400	338	22	26	12	M20
355	350	10	701 480 489	18.300	505	460	376	22	28	16	M20
450	450	10	724 705 026	38.000	615	565	470	26	36	20	M24
400	400	10	701 480 490	22.900	565	515	430	26	32	16	M24
450	500	10	701 480 491	37.000	670	620	517	26	38	20	M24
500	500	10	701 480 492	32.000	670	620	533	26	38	20	M24
560	600	10	701 480 493	53.800	780	725	618	30	42	20	M27
630	600	10	701 480 494	45.100	780	725	645	30	42	20	M27

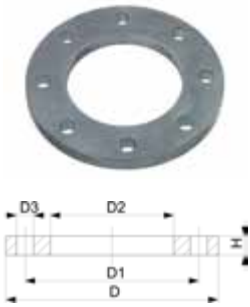

Backing flange steel metric For butt fusion systems metric

Model:

- Material: S235JR / zinc-coated
- Connecting dimensions: ISO 7005, EN 1092, DIN 2501
- **Bolt circle PN 16**

AL: number of holes

d	DN	PN	Code	Weight	D	D1	D2	D3	H	AL	SC
(mm)	(mm)	(bar)		(kg)	(mm)	(mm)	(mm)	(mm)	(mm)		
32	25	16	701 474 390	1.100	115	85	42	14	12	4	M12
40	32	16	701 474 391	1.500	140	100	51	18	14	4	M16
50	40	16	701 474 392	1.600	150	110	62	18	14	4	M16
63	50	16	701 474 393	1.900	165	125	78	18	16	4	M16
75	65	16	701 474 394	2.400	185	145	92	18	16	4	M16
90	80	16	701 474 395	2.900	200	160	108	18	18	8	M16
110	100	16	701 474 396	3.100	220	180	128	18	18	8	M16
125	100	16	701 474 397	3.060	220	180	135	18	18	8	M16
125	125	16	701 474 386	6.000	250	210	135	18	25	8	M16
140	125	16	701 474 387	3.700	250	210	158	18	18	8	M16
160	150	16	701 474 382	5.100	285	240	178	22	20	8	M20
180	150	16	701 474 398	4.800	285	240	188	22	20	8	M20
200	200	16	701 480 475	7.400	340	295	235	22	24	12	M20
225	200	16	701 480 476	7.400	340	295	238	22	24	12	M20
250	250	16	701 480 477	13.000	405	355	288	26	30	12	M24
280	250	16	701 480 478	12.600	405	355	294	26	30	12	M24
315	300	16	701 480 479	18.400	460	410	338	26	34	12	M24
355	350	16	701 480 480	25.000	520	470	376	26	35	16	M24
400	400	16	701 480 481	31.000	580	525	430	30	38	16	M27
450	500	16	701 480 482	37.000	715	650	517	33	46	20	M30
500	500	16	701 480 483	32.000	715	650	533	33	46	20	M30



Profiled backing flange steel metric For butt fusion systems metric

Model:

- Ductile iron (GGG40), epoxy coated (black)
- Connecting dimensions: ISO 7005, EN 1092, DIN 2501
- **Bolt circle PN 10**
- * Galvanized steel S235-JR, suitable for underground laying

AL: number of holes

Note:

flat side = bolt side profiled side = flange adaptor side

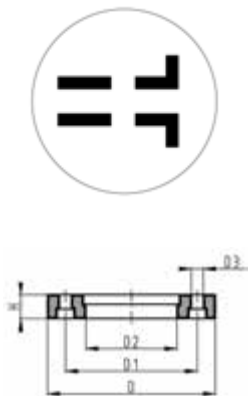

d	DN	PN	Code	Weight	D	D1	D2	D3	H	AL	SC	
(mm)	(mm)	(bar)		(kg)	(mm)	(mm)	(mm)	(mm)	(mm)			
*	450	450	10	724 705 026	38.000	615	565	470	26	44	20	M24
	710	700	6	724 705 130	36.400	900	840	740	30	45	24	M27
	800	800	6	724 705 131	50.500	1015	950	843	33	53	24	M30
	900	900	6	724 705 132	55.800	1115	1050	947	33	56	28	M30
	1000	1000	6	724 705 133	71.100	1230	1160	1050	36	62	28	M33
	1200	1200	4	724 705 134	101.000	1455	1380	1260	39	68	32	M36



Blanking flange set PE Combined jointing face flat and serrated metric

Model:

- d63 - d315: backing flange PP-V with end blank PE
- d355 - d630: backing flange PP/Steel with end blank PE
- Connecting dimensions: ISO 7005, EN 1092, DIN 2501
- **Bolt circle PN 10**

AL: number of holes

L: length of the End Blank

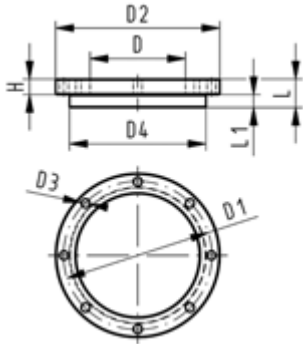

d	DN	PN	Code	Weight	D	D1	D2	D3	D4	L	L1	H	AL	SC
(mm)	(mm)	(bar)		(kg)	(mm)	(mm)	(mm)	(mm)	(mm)	(mm)	(mm)	(mm)		
63	50	16	753 700 611	0.674	75	125	165	18	102	30	14	24	4	M16
75	65	16	753 700 612	0.910	89	145	185	18	122	30	16	26	4	M16
90	80	16	753 700 613	0.921	105	160	200	18	138	30	17	27	8	M16
110	100	16	753 700 614	1.158	125	180	220	18	158	30	18	28	8	M16
125	100	16	753 700 615	1.678	132	180	220	18	158	35	25	28	8	M16
140	125	16	753 700 616	1.913	155	210	250	18	188	40	25	30	8	M16
160	150	16	753 700 617	2.373	175	240	285	22	212	40	25	32	8	M20
180	150	16	753 700 618	2.430	180	240	285	22	212	45	30	32	8	M20
200	200	16	753 700 619	3.495	232	295	340	22	268	50	32	34	8	M20
225	200	16	753 700 620	3.744	235	295	340	22	268	50	32	34	8	M20
250	250	16	753 700 621	6.051	285	350	395	22	320	55	35	38	12	M20
280	250	16	753 700 622	6.305	291	350	395	22	320	60	35	38	12	M20
315	300	16	753 700 623	8.894	335	400	445	22	370	65	35	42	12	M20
355	350	16	753 700 624	23.198	373	460	515	22	430	70	40	40	16	M20
400	400	16	753 700 625	30.766	427	515	574	26	482	75	46	40	16	M24
450	500	10	753 700 626	44.271	510	620	684	26	585	80	60	49	20	M24
500	500	10	753 700 627	47.165	530	620	684	26	585	90	60	49	20	M24
560	600	10	753 700 628	67.147	615	725	796	30	685	100	60	58	20	M27
630	600	10	753 700 629	68.574	642	725	796	30	685	110	60	68	20	M27

Blanking Flanges PE100

Model:

- Made out of sheet material
- **Bolt circle PN 10**

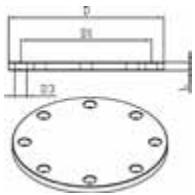

d	PN	DN	Code	Weight	AL	D	L	D1	D3
(mm)	(psi)	(mm)		(kg)		(mm)	(mm)	(mm)	(mm)
63	2,5	50	700 647 886	0.362	4	165	15	125	18
75	2,5	65	700 647 887	0.487	4	185	15	145	18
90	2,5	80	700 647 888	0.544	8	200	15	160	18
110	2,5	100	700 647 889	0.643	8	220	15	180	18
125	2,5	100	700 647 890	0.658	8	220	15	180	18
140	2,5	125	700 647 891	0.842	8	250	15	210	18
160	2,5	150	700 647 892	1.200	8	285	20	240	22
180	2,5	150	700 647 893	1.350	8	285	25	240	22
200	2,5	200	700 647 894	1.400	8	340	25	295	22
225	2,5	200	700 647 895	1.450	8	340	30	295	22
250	2,5	250	700 647 896	2.052	12	395	30	350	22
280	2,5	250	700 647 897	2.380	12	395	30	350	22
315	2,5	300	700 647 898	2.400	12	445	40	400	22
355	2,5	350	700 647 899	4.400	16	515	40	460	22
400	2,5	400	700 647 900	5.620	16	574	45	515	26
450	2,5	500	700 647 901	6.120	20	670	55	620	26
500	2,5	500	700 647 902	7.100	20	670	60	620	26
560	2,5	600	700 647 903	7.650	20	780	65	725	30
630	2,5	600	700 647 904	8.200	20	780	75	725	30

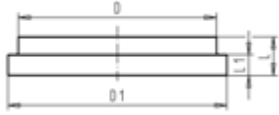

End blank PE
For butt fusion systems metric

Model:

- Suitable for metric backing flanges

d (mm)	DN (mm)	PN (bar)	Code	Weight (kg)	D (mm)	D1 (mm)	L (mm)	L1 (mm)
63	50	16	753 960 611	0.154	75	102	30	14
75	65	16	753 960 612	0.268	89	122	30	16
90	80	16	753 960 613	0.363	105	138	30	17
110	100	16	753 960 614	0.490	125	158	30	18
125	100	16	753 960 615	0.478	132	158	35	25
140	125	16	753 960 616	0.713	155	188	40	25
160	150	16	753 960 617	1.196	175	212	40	25
180	150	16	753 960 618	1.030	180	212	45	30
200	200	16	753 960 619	1.795	232	268	50	32
225	200	16	753 960 620	2.044	235	268	50	32
250	250	16	753 960 621	3.158	285	320	55	35
280	250	16	753 960 622	4.157	291	320	60	35
315	300	16	753 960 623	5.249	335	370	65	35
355	350	16	753 960 624	7.698	373	430	70	40
400	400	16	753 960 625	12.185	427	482	75	46
450	500	16	753 960 626	19.619	510	585	80	60
500	500	16	753 960 627	22.130	530	585	90	60
560	600	16	753 960 628	31.447	615	685	100	60
630	600	16	753 960 629	36.074	642	685	110	60

Flange adaptor socket fusion systems



ecoFIT flange adaptor Jointing face flat/serrated

Model:

- Material: PE100
- Counterpart: flange adaptor flat/serrated or with O-ring groove
- Connection: according to EN ISO 15494-, DIN 16963-11
- Gasket: profile flange gasket EPDM No. 48 44 07, FPM No. 49 44 07
- Flanges: PP - steel, No. 27 70 02, PP-V, No 27 70 04

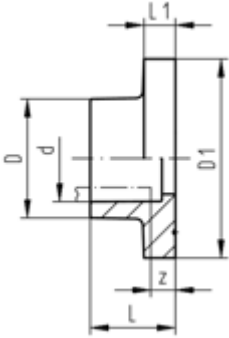

d	DN	PN	Code	Weight	D	D1	L	L1	z
(mm)	(mm)	(bar)		(kg)	(mm)	(mm)	(mm)	(mm)	(mm)
20	15	10	753 790 206	0.013	27	45	19	7	5
25	20	10	753 790 207	0.022	33	58	21	9	5
32	25	10	753 790 208	0.035	41	68	23	10	5
40	32	10	753 790 209	0.052	50	78	25	11	5
50	40	10	753 790 210	0.061	61	88	28	12	5
63	50	10	753 790 211	0.095	76	102	32	14	5
75	65	10	753 790 212	0.163	90	122	36	16	5
90	80	10	753 790 213	0.203	108	138	42	17	7
110	100	10	753 790 214	0.293	131	158	48	18	7



ecoFIT flange adaptor Jointing face with o-ring groove

Model:

- Material: PE80
- Counterpart: flange adaptor flat/serrated 53 79 02
- Gasket: O-ring EPDM
- Flanges: PP - steel, No. 27 70 02, PP-V, No 27 70 04

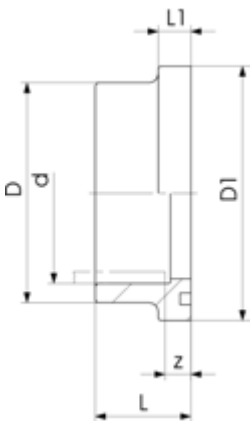

d	DN	PN	Code	Weight	D	D1	L	L1	z
(mm)	(mm)	(bar)		(kg)	(mm)	(mm)	(mm)	(mm)	(mm)
20	15	10	733 810 106	0.008	27	34	22	9	8
25	20	10	733 810 107	0.012	33	41	24	10	8
32	25	10	733 810 108	0.019	41	50	26	10	8
40	32	10	733 810 109	0.031	50	61	30	13	10
50	40	10	733 810 110	0.044	61	73	33	13	10
63	50	10	733 810 111	0.072	76	90	37	14	10
75	65	10	733 810 112	0.112	90	106	40	15	10
90	80	10	733 810 113	0.185	108	125	47	16	12
110	100	10	733 810 114	0.285	131	150	55	18	13



ecoFIT outlet flange adaptor
Jointing face flat

Model:

- Material: PE80
- With fusion socket metric
- Suitable for wafer check valves Type 369
- To be installed on the outlet side of the valve
- Use flanges PP-V 27 70 04

d	DN	PN	Code	Weight	D	D1	L	L1	z
(mm)	(mm)	(bar)		(kg)	(mm)	(mm)	(mm)	(mm)	(mm)
40	32	6	733 800 009	0.065	50	78	55	11	35
50	40	6	733 800 010	0.088	61	88	61	12	38
63	50	6	733 800 011	0.136	76	102	69	14	41
75	65	6	733 800 012	0.223	90	122	79	16	49
90	80	6	733 800 013	0.357	107	138	100	17	65
110	100	6	733 800 014	0.482	130	158	105	18	62

Flanges for socket fusion systems

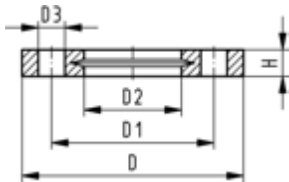

Backing flange PP-V metric For socket systems metric and BS

Model:

- Connecting dimension: ISO 7005, EN 1092, BS 4504, DIN 2501
- **Bolt circle PN 10**
- Full-plastic flange PP-GF (30 % glass-fibre reinforced)

¹⁾ Suitable for socket- and butt fusion systems

²⁾ Not for BS

³⁾ Combined version, metric - ANSI

AL: number of holes

	d (mm)	DN (mm)	PN (bar)	Code	Weight (kg)	D (mm)	D1 (mm)	D2 (mm)	D3 (mm)	H (mm)	AL	SC
1	20	15	16	727 700 406	0.093	95	65	28	14	16	4	M12
1	25	20	16	727 700 407	0.120	105	75	34	14	17	4	M12
1	32	25	16	727 700 408	0.151	115	85	42	14	18	4	M12
1	40	32	16	727 700 409	0.244	140	100	51	18	20	4	M16
1	50	40	16	727 700 410	0.297	150	110	62	18	22	4	M16
1	63	50	16	727 700 411	0.362	165	125	78	18	24	4	M16
1	75	65	16	727 700 412	0.487	185	145	92	18	26	4	M16
	90	80	16	727 700 413	0.550	200	160	110	18	27	8	M16
2	110	100	16	727 700 414	0.640	220	180	133	18	28	8	M16

Backing flange PP-Steel metric For socket systems metric and BS

Model:

- **Bolt circle PN 10**
- PP-GF (30% glass-fibre reinforced) with steel ring
- UV-resistant. Applicable for outside applications
- Connecting dimension: ISO 7005, EN 1092, BS 4504, DIN 2501

AL: number of holes

¹⁾ Suitable for socket -and butt fusion systems

²⁾ Not for BS

³⁾ Connecting dimension: ISO 2536. bolt circle acc. DN125. suitable for flange adaptor d125/ DN100

⁴⁾ Connecting dimension: ISO 2536. bolt circle acc. DN225. suitable for flange adaptor d250/ DN250

⁵⁾ Combined version, bolt circle metric - ANSI

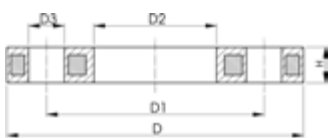

	d (mm)	DN (mm)	PN (bar)	Code	Weight (kg)	D1 (mm)	D3 (mm)	D2 (mm)	D (mm)	H (mm)	AL	SC
1	20	15	16	727 700 206	0.216	65	14	28	95	12	4	M12
1	25	20	16	727 700 207	0.279	75	14	34	105	12	4	M12
1	32	25	16	727 700 208	0.429	85	14	42	115	16	4	M12
1	40	32	16	727 700 209	0.621	100	18	51	140	16	4	M16
1	50	40	16	727 700 210	0.722	110	18	62	150	20	4	M16
1	63	50	16	727 700 211	1.084	125	18	78	165	20	4	M16
1	75	65	16	727 700 212	1.349	145	18	92	185	20	4	M16
	90	80	16	727 700 213	1.369	160	18	110	200	20	8	M16
2	110	100	16	727 700 214	1.522	180	18	133	220	20	8	M16

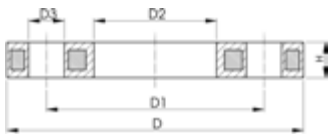

Backing Flange PP-Steel Inch/ANSI For socket systems metric and BS

Model:

- Material: PP (30% glass-fibre reinforced) with steel ring
- Connecting dimension: ANSI/ASME B 16.5 class 150, ASTM D 4024, BS 1560, BS EN 1759
- **Bolt circle class 150**
- Special flange adapter ANSI for d25 - d50 and d90 required

¹⁾ Suitable for socket -and butt fusion systems

²⁾ Not for BS

³⁾ Combined version, bolt circle metric - ANSI

AL: number of holes

	d (inch)	d (mm)	DN (mm)	PN (bar)	Code	Weight (kg)	D (mm)	D1 (mm)	D2 (mm)	D3 (mm)	H (mm)	AL	SC
1	½	20	15	16	727 701 206	0.213	95	60	28	16	12	4	M12
1	¾	25	20	16	727 701 207	0.260	105	70	34	16	12	4	M12
1	1	32	25	16	727 701 208	0.416	115	79	42	16	16	4	M12
1	1 ¼	40	32	16	727 701 209	0.730	140	89	51	16	16	4	M16
1	1 ½	50	40	16	727 701 210	0.809	150	98	62	16	18	4	M16
1	2	63	50	16	727 701 211	0.866	165	121	78	19	18	4	M16
1	2 ½	75	65	16	727 701 212	1.117	185	140	92	19	18	4	M16
	3	90	80	16	727 701 213	1.492	200	152	110	19	20	4	M16
2	4	110	100	16	727 701 214	1.695	229	190	133	19	20	8	M16
3	8	200	200	16	727 700 819	6.143	340	297	226	22	29	8	M20
3	8	225	200	16	727 700 820	4.448	340	297	250	22	29	8	M20

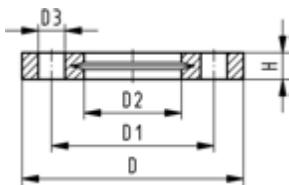

Backing flange PP-V Inch ANSI For socket systems metric and BS

Model:

- Full-plastic flange PP-GF (30 % glass-fibre reinforced)
- Connecting dimension: ANSI/ASME B 16.5 class 150, ASTM D 4024, BS 1560, BS EN 1759
- **Bolt circle class 150**
- Special flange adapter ANSI for d25 - d50 and d90 required

AL: number of holes

¹⁾ Suitable for socket- and butt fusion systems

²⁾ Not for BS

³⁾ Combined version, metric - ANSI

	Size (inch)	DN (mm)	d (mm)	PN (bar)	Code	Weight (kg)	D (mm)	D1 (mm)	D2 (mm)	D3 (mm)	H (mm)	AL	SC
1	½	15	20	16	727 701 406	0.091	95	60	28	16	16	4	M12
1	¾	20	25	16	727 701 407	0.120	105	70	34	16	17	4	M12
1	1	25	32	16	727 701 408	0.147	115	79	42	16	18	4	M12
1	1 ¼	32	40	16	727 701 409	0.246	140	89	51	16	20	4	M16
1	1 ½	40	50	16	727 701 410	0.299	150	98	62	16	22	4	M16
1	2	50	63	16	727 701 411	0.361	165	121	78	19	24	4	M16
1	2 ½	65	75	16	727 701 412	0.492	185	140	92	19	26	4	M16
	3	80	90	16	727 701 413	0.605	200	152	110	19	27	4	M16
2	4	100	110	16	727 701 414	0.704	229	190	133	19	28	8	M16
2/3	6	150	160	16	727 700 417	1.050	285	240	190	22	32	8	M20
3	8	200	200	16	727 700 419	1.629	340	295	226	22	34	8	M20
3	8	200	225	16	727 700 420	1.400	340	295	250	22	34	8	M20
	10	250	280	16	727 701 422	1.838	406	362	310	26	38	12	M20
	12	300	315	16	727 701 423	3.482	483	432	348	26	42	12	M20

Gaskets

Gaskets for Socket Fusion



Flat gasket EPDM

Model:

- For all metric GF Flange Adaptors
 - Hardness approx. 65° Shore
 - Integrated fixation aids from d110
 - Centering on the inner diameter of the screw crown
- di FA are the suitable inner diameters of flanges adaptors

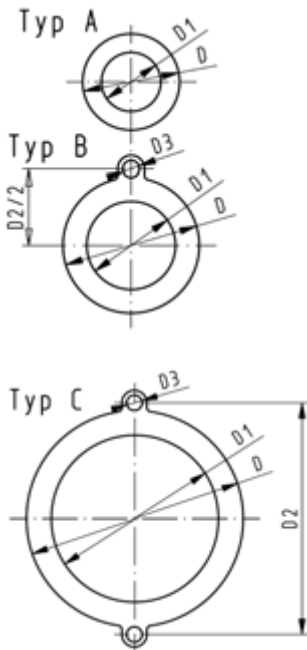

d (mm)	DN (mm)	PN (bar)	Type	EPDM Code	Weight (kg)	D (mm)	D1 (mm)	D2 (mm)	D3 (mm)	H (mm)	di FA (mm)
16	10	10	A	748 400 305	0.004	46	16			2	6 - 26
20	15	10	A	748 400 306	0.012	51	20			2	10 - 30
25	20	10	A	748 400 307	0.004	61	25			2	15 - 35
32	25	10	A	748 400 308	0.008	71	32			2	22 - 42
40	32	10	A	748 400 309	0.013	82	40			3	30 - 50
50	40	10	A	748 400 310	0.016	92	50			3	40 - 60
63	50	10	A	748 400 311	0.018	107	63			3	53 - 73
75	65	10	A	748 400 312	0.029	127	71			3	61 - 81
90	80	10	A	748 400 313	0.035	142	84			3	74 - 94
110	100	10	B	748 400 314	0.051	162	104	180	18	4	94 - 114

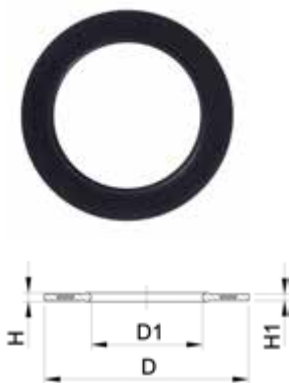

Profile Flange Gasket, metric EPDM / FPM

Model:

- For all metric GF Flange Adaptors
- Hardness: 70° Shore EPDM, 75° Shore FPM
- EPDM: approved acc. to DVGW W 270, KTW recommendation
- Centering on the inner diameter of the screw crown
- material steel insert: carbon steel
- Rubber-steel body combined with rubber profile cord ring

di FA are the suitable inner diameters of flanges adaptors

d (mm)	PN (bar)	DN (mm)	EPDM Code	FPM Code	Weight (kg)	D (mm)	D1 (mm)	di FA (mm)	H (mm)	H1 (mm)
16	16	10	748 440 705	749 440 705	0.012	46	16	6 - 16	4	3
20	16	15	748 440 706	749 440 706	0.013	51	20	10 - 20	4	3
25	16	20	748 440 707	749 440 707	0.014	61	22	12 - 22	4	3
32	16	25	748 440 708	749 440 708	0.019	71	28	18 - 28	4	3
40	16	32	748 440 709	749 440 709	0.026	82	40	30 - 40	4	3
50	16	40	748 440 710	749 440 710	0.039	92	46	36 - 46	4	3
63	16	50	748 440 711	749 440 711	0.050	107	58	48 - 58	5	4
75	16	65	748 440 712	749 440 712	0.082	127	69	59 - 69	5	4
90	16	80	748 440 713	749 440 713	0.083	142	84	73 - 84	5	4
110	16	100		749 440 714	0.127	162	104	94 - 104	6	5

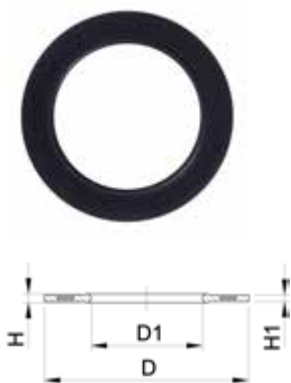

Profile flange gasket metric NBR

Model:

- NBR = Nitrile rubber, hardness approx. 80° Shore
- For all metric GF Flange Adaptors
- Rubber-steel body combined with rubber profile cord ring
- Approved acc. to DVGW standard DIN EN 682 for gas
- D corresponds to the centring at the inner diameter of the screw crown

d (mm)	DN (mm)	PN (bar)	NBR/DUO Code	Weight (kg)	D (mm)	D1 (mm)	H (mm)	H1 (mm)	di FA (mm)
20	15	16	745 440 706	0.009	51	20	4	3	10 - 20
25	20	16	745 440 707	0.012	61	22	4	3	12 - 22
32	25	16	745 440 708	0.018	71	28	4	3	18 - 28
40	32	16	745 440 709	0.021	82	40	4	3	30 - 40
50	40	16	745 440 710	0.029	92	46	4	3	36 - 46
63	50	16	745 440 711	0.039	107	58	5	4	48 - 58
75	65	16	745 440 712	0.058	127	69	5	4	59 - 69
90	80	16	745 440 713	0.063	142	84	5	4	73 - 84
110	100	16	745 440 714	0.096	162	104	6	5	94 - 104

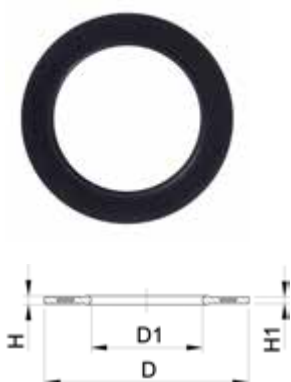

Profile flange gasket metric For flange adaptors without chamfer

Model:

- For flange adaptor No. 27 79 85 PP-H SDR11 without chamfer
- Profile Gasket with carbon steel insert (type G-ST-P/K)
- Hardness: 70° shore EPDM, 75° shore FPM

d (mm)	DN (mm)	PN (bar)	EPDM Code	Weight (kg)	FPM Code	Weight (kg)	D (mm)	D1 (mm)	di FA (mm)	H (mm)	H1 (mm)
20	15	16	748 440 706	0.009	749 440 706	0.013	51	20	10 - 20	4	3
25	20	16	748 440 707	0.015	749 440 707	0.014	61	22	12 - 22	4	3
32	25	16	748 440 708	0.013	749 440 708	0.019	71	28	18 - 28	4	3
40	32	16	748 440 709	0.019	749 440 709	0.026	82	40	30 - 40	4	3
50	40	16	748 440 710	0.029	749 440 710	0.039	92	46	36 - 46	4	3
63	50	16	748 440 711	0.041	749 440 711	0.050	107	58	48 - 58	5	4
75	65	16	748 440 712	0.053	749 440 712	0.082	127	69	59 - 69	5	4
90	80	16	748 440 713	0.064	749 440 713	0.083	142	84	73 - 84	5	4



O-Ring gasket

Model:

- For flange adaptors
- Hardness approx. 65° Shore

d (mm)	DN (mm)	EPDM Code	Weight (kg)	FPM Code	Weight (kg)	D (mm)	D1 (mm)	D2 (mm)	closest inch (inch)
16	10	748 410 000	0.002	749 410 000	0.005	26	19	3.53	3/8
20	15	748 410 001	0.002	749 410 001	0.002	31	23	3.53	1/2
25	20	748 410 007	0.002	749 410 007	0.002	35	28	3.53	3/4
32	25	748 410 002	0.003	749 410 002	0.003	43	36	3.53	1
40	32	748 410 003	0.004	749 410 003	0.002	55	44	5.34	1 1/4
50	40	748 410 012	0.004	749 410 012	0.008	64	53	5.34	1 1/2
63	50	748 410 013	0.006	749 410 013	0.011	80	69	5.34	2
75	65	748 410 014	0.007	749 410 014	0.012	93	82	5.34	2 1/2
90	80	748 410 015	0.008	749 410 015	0.015	112	101	5.34	3
110	100	748 410 016	0.016	749 410 016	0.031	134	120	6.99	4

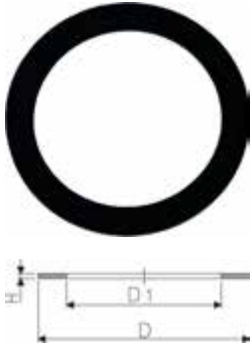

Flat gasket

Model:

- Hardness approx. 65° Shore
- For adaptor unions

Size (inch)	EPDM Code	Weight (kg)	FPM Code	Weight (kg)	D (mm)	D1 (mm)	H (mm)
¼	748 400 004	0.002			20	13	2
⅜	748 400 005	0.002	749 400 005	0.020	24	17	2
½	748 400 006	0.002	749 400 006	0.003	30	21	3
¾	748 400 007	0.004	749 400 007	0.004	38	27	3
1	748 400 008	0.002	749 400 008	0.002	44	32	3
1 ¼	748 400 009	0.007	749 400 009	0.003	55	42	3
1 ½	748 400 010	0.004	749 400 010	0.007	62	46	3
2	748 400 011	0.005	749 400 011	0.006	78	60	3
2 ½	748 400 012	0.010	749 400 012	0.009	97	75	3
3	748 400 013	0.011	749 400 013	0.011	109	88	3

Gaskets for Butt Fusion



Flat gasket EPDM

Model:

- For all metric GF Flange Adaptors
 - Hardness approx. 65° Shore
 - Integrated fixation aids from d110
 - Centering on the inner diameter of the screw crown
- di FA are the suitable inner diameters of flanges adaptors

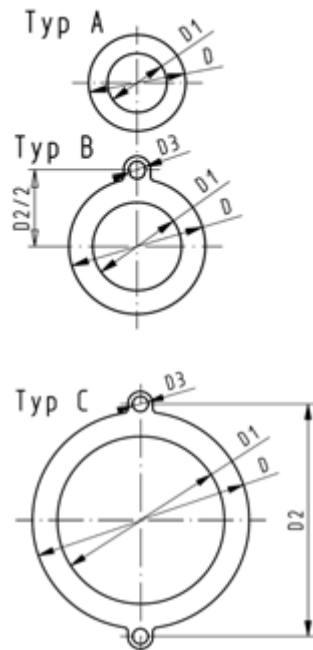

d (mm)	DN (mm)	PN (bar)	Type	EPDM Code	Weight (kg)	D (mm)	D1 (mm)	D2 (mm)	D3 (mm)	H (mm)	di FA (mm)
16	10	10	A	748 400 305	0.004	46	16			2	6 - 26
20	15	10	A	748 400 306	0.012	51	20			2	10 - 30
25	20	10	A	748 400 307	0.004	61	25			2	15 - 35
32	25	10	A	748 400 308	0.008	71	32			2	22 - 42
40	32	10	A	748 400 309	0.013	82	40			3	30 - 50
50	40	10	A	748 400 310	0.016	92	50			3	40 - 60
63	50	10	A	748 400 311	0.018	107	63			3	53 - 73
75	65	10	A	748 400 312	0.029	127	71			3	61 - 81
90	80	10	A	748 400 313	0.035	142	84			3	74 - 94
110	100	10	B	748 400 314	0.051	162	104	180	18	4	94 - 114
125	100	10	B	748 400 315	0.044	162	119	180	18	4	109 - 129
140	125	10	B	748 400 316	0.068	192	134	210	18	4	124 - 144
160 - 180	150	10	B	748 400 317	0.090	218	155	241	22	4	145 - 165
200	200	6	C	748 400 319	0.210	273	195	295	22	5	185 - 205
225	200	6	C	748 400 320	0.140	273	216	295	22	5	206 - 226
250	250	6	C	748 400 321	0.210	328	250	350	22	5	240 - 260
280	250	6	C	748 400 322	0.151	328	273	350	22	5	263 - 283
315	300	6	C	748 400 323	0.237	378	305	400	22	5	295 - 315

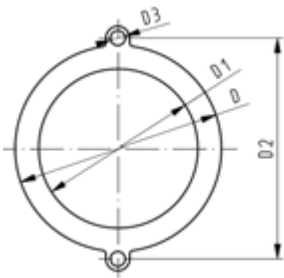

Flat gasket for flange adaptor

Model:

- Hardness: EPDM ca. 70° shore
- Flange bolt circle: PN10
- Integrated fixation aids
- Centering on the inner diameter of the screw crown

PN* (bar)	d (mm)	DN (mm)	EPDM Code	Weight (kg)	D2 (mm)	D3 (mm)	D1 (mm)	H (mm)	D (mm)
6	710	700	748 400 330	0.900	840	30	625	5	810
6	800	800	748 400 331	1.000	950	33	705	5	917
6	900	900	748 400 332	1.200	1050	36	805	5	1014
6	1000	1000	748 400 333	1.400	1160	39	890	5	1121

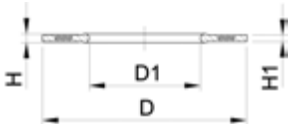

Profile Flange Gasket, metric EPDM / FPM

Model:

- For all metric GF Flange Adaptors
- Hardness: 70° Shore EPDM, 75° Shore FPM
- EPDM: approved acc. to DVGW W 270, KTW recommendation
- Centering on the inner diameter of the screw crown
- material steel insert: carbon steel
- Rubber-steel body combined with rubber profile cord ring

di FA are the suitable inner diameters of flanges adaptors

d (mm)	PN (bar)	DN (mm)	EPDM Code	FPM Code	Weight (kg)	D (mm)	D1 (mm)	di FA (mm)	H (mm)	H1 (mm)
16	16	10	748 440 705	749 440 705	0.012	46	16	6 - 16	4	3
20	16	15	748 440 706	749 440 706	0.013	51	20	10 - 20	4	3
25	16	20	748 440 707	749 440 707	0.014	61	22	12 - 22	4	3
32	16	25	748 440 708	749 440 708	0.019	71	28	18 - 28	4	3
40	16	32	748 440 709	749 440 709	0.026	82	40	30 - 40	4	3
50	16	40	748 440 710	749 440 710	0.039	92	46	36 - 46	4	3
63	16	50	748 440 711	749 440 711	0.050	107	58	48 - 58	5	4
75	16	65	748 440 712	749 440 712	0.082	127	69	59 - 69	5	4
90	16	80	748 440 713	749 440 713	0.083	142	84	73 - 84	5	4
110	16	100	748 440 714	749 440 714	0.127	162	104	94 - 104	6	5
125	16	100	748 440 715	749 440 715	0.105	162	123	113 - 123	6	5
140	16	125	748 440 716	749 440 716	0.173	192	137	127 - 137	6	5
160 - 180	16	150	748 440 717	749 440 717	0.207	218	160	150 - 160	8	6
200	16	200	748 440 719	749 440 719	0.263	273	203	192 - 203	8	6
225	16	200	748 440 720	749 440 720	0.255	273	220	207 - 220	8	6
250	16	250	748 440 721	749 440 721	0.462	328	252	238 - 252	8	6
280	16	250	748 440 722	749 440 722	0.323	328	274	264 - 274	8	6
315	16	300	748 440 723	749 440 723	0.549	378	306	296 - 306	8	6
355	16	350	748 440 724	749 440 724	0.870	438	355	340 - 355	10	7
400	16	400	748 440 725	749 440 725	1.088	489	400	385 - 400	10	7
450	16	500	748 440 726	749 440 726	0.718	594	403	393 - 403	10	7
500	16	500	748 440 727	749 440 727	0.718	594	447	437 - 447	10	7
560	16	600	748 440 728	749 440 728	0.923	695	494	484 - 494	10	7
630	16	600	748 440 729	749 440 729	0.923	695	555	545 - 555	10	7

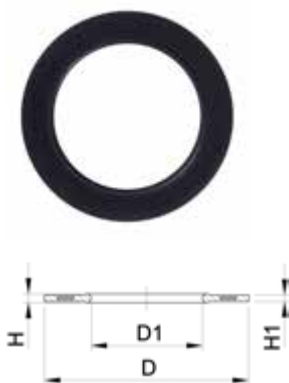

Profile flange gasket metric NBR

Model:

- NBR = Nitrile rubber, hardness approx. 80° Shore
- For all metric GF Flange Adaptors
- Rubber-steel body combined with rubber profile cord ring
- Approved acc. to DVGW standard DIN EN 682 for gas
- D corresponds to the centring at the inner diameter of the screw crown

d (mm)	DN (mm)	PN (bar)	NBR/DUO Code	Weight (kg)	D (mm)	D1 (mm)	H (mm)	H1 (mm)	di FA (mm)
20	15	16	745 440 706	0.009	51	20	4	3	10 - 20
25	20	16	745 440 707	0.012	61	22	4	3	12 - 22
32	25	16	745 440 708	0.018	71	28	4	3	18 - 28
40	32	16	745 440 709	0.021	82	40	4	3	30 - 40
50	40	16	745 440 710	0.029	92	46	4	3	36 - 46
63	50	16	745 440 711	0.039	107	58	5	4	48 - 58
75	65	16	745 440 712	0.058	127	69	5	4	59 - 69
90	80	16	745 440 713	0.063	142	84	5	4	73 - 84
110	100	16	745 440 714	0.096	162	104	6	5	94 - 104
125	100	16	745 440 715	0.073	162	123	6	5	113 - 123
140	125	16	745 440 716	0.128	192	137	6	5	127 - 137
160 - 180	150	16	745 440 717	0.145	218	160	8	6	150 - 160
200	200	16	745 440 719	0.286	273	203	8	6	192 - 203
225	200	16	745 440 720	0.183	273	220	8	6	207 - 220
250	250	16	745 440 721	0.355	328	252	8	6	238 - 252
280	250	16	745 440 722	0.229	328	274	8	6	264 - 274
315	300	16	745 440 723	0.419	378	306	8	6	296 - 306
355	350	16	745 440 724	0.645	438	355	10	7	340 - 355
400	400	16	745 440 725	0.819	489	400	10	7	385 - 400
450	500	16	745 440 726	1.885	594	403	10	7	393 - 403
500	500	16	745 440 727	1.618	594	447	10	7	437 - 447
560	600	16	745 440 728	2.281	695	494	10	7	484 - 494
630	600	16	745 440 729	2.000	695	555	10	7	545 - 555

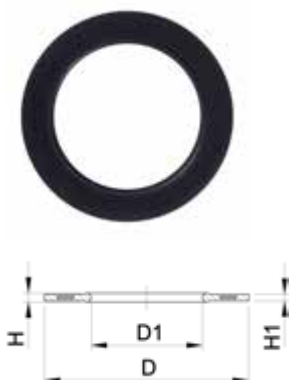

Profile Flange Gaskets ANSI

Model:

- Suitable for flanges adaptors PP/PE PVDF
- Hardness: 70° Shore EPDM, 75° Shore FPM
- Centered by the flange bolts
- Dimension D is in accordance with the inner diameter of the bolt circle

d (mm)	EPDM Code	Weight (kg)	FPM Code	Weight (kg)	Inch (inch)	DN (mm)	D (mm)	D1 (mm)	H (mm)	H1 (mm)
25	748 440 502	0.010	749 440 502	0.011	3/4	20	54	27	4	3
32	748 440 503	0.011	749 440 503	0.023	1	25	64	33	4	3
40	748 440 504	0.017	749 440 504	0.024	1 1/4	32	73	42	4	3
50	748 440 505	0.030	749 440 505	0.030	1 1/2	40	83	48	4	3
63	748 440 506	0.029	749 440 506	0.042	2	50	102	60	5	4
75	748 440 507	0.046	749 440 507	0.068	2 1/2	65	121	73	5	4
90	748 440 508	0.053	749 440 508	0.083	3	80	133	89	5	4
110	748 440 509	0.088	749 440 509	0.139	4	100	171	115	6	5
160 - 180	748 440 512	0.127	749 440 512	0.240	6	150	222	160	8	6
225	748 440 515	0.195	749 440 515	0.316	8	200	279	220	8	6
250	748 440 517	0.243	749 440 517	0.373	10	250	337	273	8	6
315	748 440 518	0.398	749 440 518	0.750	12	300	406	325	8	6
355	748 440 519	0.800	749 440 519	0.800	14	350	448	356	10	7
400	748 440 520	0.900	749 440 520	0.900	16	400	512	406	10	7
450	748 440 521	1.000	749 440 521	1.000	18	450	547	457	10	7
500	748 440 522	1.000	749 440 522	1.000	20	500	604	508	10	7

Tested beyond the standard

Polyethylene piping systems for
underground fire protection

FM APPROVED

Factory mutual (FM) approved piping systems – used for water supply in fire protection systems

The Factory Mutual Research Corporation (FMRC) is the testing laboratory that is internationally recognized for its work testing components for fire protection systems. Components for fire protection systems are tested to ensure that the products can pass an aggressive level of performance, safety and quality standards. Any GF product that is labelled with the Factory Mutual <FM> symbol indicates that the product has met and even exceeded the rigorous requirements for fire protection systems. The manufacturing processes and the in-house testing facilities at GF have been inspected and approved by FMRC, and are audited frequently to ensure compliance and to promote continuing improvement.



+ Benefits & features

FM – Factory mutual

... is the world's biggest industrial property insurance and risk management organisation.

FM – Approval

... assures your customer's optimal risk management and protection from property loss.

FM – Critical elements

... piping system used for water supply in fire protection systems. Moving the water from its source to its final point of use is often considered the most critical component of the underground system.

FM – Performance

... fire prevention systems must be extremely reliable and capable of safely withstanding both internal and external stresses over long periods of time. More rigorous testing and auditing by FM Approvals personnel ensure enhanced reliability, confidence and quality.

Many companies with international operations build on and insure their properties according to the FM-standards.

Essential parts are the selection, construction and installation of the buried fire-extinguishing pipe system. The material of choice is PE100, which is used for underground FM approved pipes and fittings from GF.

The range

- Pipe
- Fittings
 - Elbows
 - Tees
 - Reducers
 - Caps
 - Adapters
 - Couplings
 - Branch saddles
 - Transition fittings

Overview of GF Piping Systems products with FM-approval

+ Now the details



Product	FM class 10 bar	Class 150 (11 bar)	FM class 12 bar	Class 200 13.8 bar	Class 267 18.4 bar
Pipe	90 - 400 mm	2 - 24"	90 - 500 mm	2 - 24"	4 - 24"
Spigot fittings for electro fusion ** (ISO/DIN)					
Bend / Elbow 45°	355 - 500 mm		90 - 315 mm		
Bend / Elbow 90°	355 - 500 mm		90 - 315 mm		
Tee 90° equal	355 - 500 mm		90 - 315 mm		
End cap	355 - 500 mm		90 - 315 mm		
Flange adaptor	355 - 500 mm		90 - 315 mm		
Backing ring					
Reducer	400 - 355 mm		90 - 355 mm		
ELGEF fittings (ISO/DIN)					
Coupler			90 - 500 mm		
Branch saddle			110 - 630 mm (branch 90 - 125 mm)		
Spigot fittings for butt fusion (ASTM)					
45° Elbows		2 - 24"		2 - 24"	4 - 24"
90° Elbows		2 - 24"		2 - 24"	4 - 24"
22.5° Elbows		2 - 24"		2 - 24"	4 - 24"
Tee equal		4 - 24"		4 - 24"	4 - 24"
Tee reduced branch		2 - 24"		2 - 24"	4 - 24"
Flange adaptor		2 - 36"		2 - 36"	4 - 24"
Backing ring		2 - 36"		2 - 36"	4 - 24"
Reducer		2 - 24"		2 - 24"	4 - 24"
Branch saddle		main* 2 - 12 " outlet		main* 2 - 12 " outlet	
Anchor ring		2 - 24"		2 - 24"	4 - 24"
Mechanical joint adaptor		2 - 24"		2 - 24"	

* Available in Butt Fusion and Electrofusion , size depending

** Spigot fittings (ISO/DIN) can only be installed using electrofusion
Note Inch sizes are Iron Pipe sizes (IPS) and Ductile Pipe Sizes (DPS) equivalent

For more details please contact your local sales Office

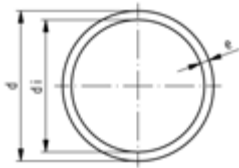

ecoFIT pipe SDR11 5m/12m

Model:

- Material: PE100
- Colour: RAL 9011 graphite black
- Dimension: DIN 8074
- Pipe length: 5m, with plain ends
- Pipe length: 12m, with plain ends
- Material: PE 100, Polyethylene

d (mm)	Code	Weight (kg/m)	e (mm)	di (mm)	FM PN (bar)	Length (m)
110	316 110 022	3.180	10.0	90.0	10	5
125	316 125 029	4.120	11.4	102.8	10	5
140	316 140 018	5.130	12.7	114.6	10	5
160	316 160 020	6.730	14.6	130.8	10	5
180	316 180 019	8.510	16.4	147.2	10	5
200	316 200 012	10.500	18.2	163.6	10	5
225	316 225 009	13.300	20.5	184.0	10	5
250	316 250 005	16.300	22.7	204.6	10	5
280	316 280 019	20.500	25.4	229.2	10	5
315	316 315 008	25.900	28.6	257.8	10	5
355	316 355 017	32.900	32.2	290.6	10	5
400	316 400 008	41.700	36.3	327.4	10	5
110	316 110 039	3.180	10.0	90.0	10	12
125	316 125 031	4.120	11.4	102.8	10	12
140	316 140 027	5.130	12.7	114.6	10	12
160	316 160 019	6.730	14.6	130.8	10	12
180	316 180 020	8.510	16.4	147.2	10	12
200	316 200 014	10.500	18.2	163.6	10	12
225	316 225 010	13.300	20.5	184.0	10	12
250	316 250 009	16.300	22.7	204.6	10	12
280	316 280 024	20.500	25.4	229.2	10	12
315	316 315 009	25.900	28.6	257.8	10	12
355	316 355 020	32.900	32.2	290.6	10	12
400	316 400 010	41.700	36.3	327.4	10	12

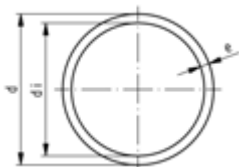
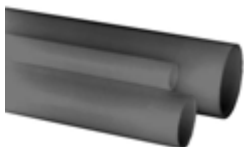

ecoFIT pipe SDR9

Model:

- Material: PE100

d (mm)	Code	e (mm)	di (mm)	FM PN (bar)
90	on request	10.0	90.0	12
110	on request	10.0	90.0	12
125	on request	11.4	102.8	12
140	on request	12.7	114.6	12
160	on request	14.6	130.8	12
180	on request	16.4	147.2	12
200	on request	18.2	163.6	12
225	on request	20.5	184.0	12
250	on request	22.7	204.6	12
280	on request	25.4	229.2	12
315	on request	28.6	257.8	12
355	on request	32.2	290.6	12
400	on request	36.3	327.4	12
450	on request	40.9	368.2	12
500	on request	40.9	368.2	12

Accessories



Tangit KS Cleaner

- Special cleaner for plastic fusion connections in the material of PP, PE, PVDF and PB
- Suitable for Tangit Rapid. Must not be used for solvent cementing
- DVGW approved
- DW 5290 BR 0464

Size	Code	Weight (kg)
1 liter	799 298 023	0.872



Degreasing Tissues

- For degreasing the PE pipe surface prior to fusion

description	Type	Code	Weight (kg)
For pipes up to d225 mm	large	799 496 011	0.008



Marker

Type	Code	Weight (kg)
silver	799 350 364	0.010

Industry Product Ranges

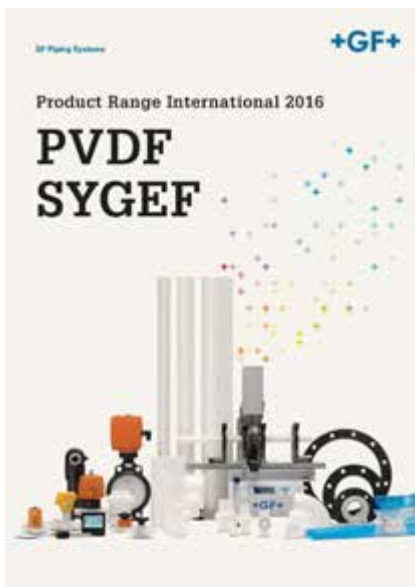
**Product Range PVC-U 2016****Product Range Signet
Measurement and Control****Product Range SYGEF and PVDF 2016****Automation made easy**

Further Product Ranges you will find at:

http://www.gfps.com/int/en/support_and_services/downloads/industrial-systems.html

Index

Code	Page	Code	Page	Code	Page	Code	Page
159 001 267	97	161 514 316	147	161 546 826	140	161 578 025	149
159 001 268	97	161 514 317	147	161 546 827	140	161 578 026	149
159 001 269	98	161 543 462	145	161 546 828	140	161 578 027	149
159 001 270	98	161 543 463	145	161 546 829	140	161 578 028	149
159 001 435	97	161 543 464	145	161 546 830	140	161 578 029	149
159 001 436	97	161 543 465	145	161 546 832	140	161 578 030	149
159 001 437	97	161 543 466	145	161 546 833	140	161 591 121	93
159 001 454	98	161 543 467	145	161 546 834	140	161 591 122	93
159 001 456	98	161 543 472	145	161 546 835	140	161 591 123	93
159 001 513	97	161 543 473	145	161 546 836	140	161 591 124	93
159 001 514	97	161 543 474	145	161 546 837	140	161 591 125	93
159 001 515	97	161 543 475	145	161 546 838	140	161 591 126	93
159 001 516	97	161 543 476	145	161 546 839	140	161 591 127	93
159 001 517	97	161 543 477	145	161 546 840	140	161 591 128	93
159 001 518	97	161 543 482	146	161 561 142	150	161 591 129	93
159 001 519	97	161 543 483	146	161 561 143	150	161 591 130	93
159 001 520	97	161 543 484	146	161 561 144	150	161 591 131	93
159 001 521	97	161 543 485	146	161 561 145	150	161 591 132	93
159 001 522	97	161 543 486	146	161 561 146	150	161 591 133	93
159 001 523	97	161 543 487	146	161 561 147	150	161 591 134	93
159 001 524	97	161 543 492	146	161 561 148	150	161 591 135	93
159 001 525	97	161 543 493	146	161 561 149	150	161 591 136	93
159 001 526	97	161 543 494	146	161 561 150	150	161 591 137	93
159 001 527	97	161 543 495	146	161 562 142	151	161 591 138	93
159 001 528	97	161 543 496	146	161 562 143	151	161 591 139	94
159 300 001	99	161 543 497	146	161 562 144	151	161 591 140	94
159 300 002	99	161 546 761	138	161 562 145	151	161 591 141	94
159 300 003	99	161 546 762	138	161 562 146	151	161 591 142	94
159 300 004	99, 100	161 546 763	138	161 562 147	151	161 591 143	94
159 300 005	99, 100	161 546 764	138	161 562 148	151	161 591 144	94
159 300 006	99, 100	161 546 765	138	161 562 149	151	161 591 145	94
159 300 007	99, 100	161 546 766	138	161 562 150	151	161 591 146	94
159 300 008	99, 100	161 546 767	138	161 567 002	148	161 591 147	94
159 300 009	99, 100	161 546 771	138	161 567 003	148	161 591 148	94
159 300 010	99, 100	161 546 772	138	161 567 004	148	161 591 149	94
159 300 011	99, 100	161 546 773	138	161 567 005	148	161 591 150	94
159 300 012	100	161 546 774	138	161 567 006	148	161 591 151	94
159 300 075	99	161 546 775	138	161 567 007	148	161 591 152	94
159 300 076	99	161 546 776	138	161 567 008	148	161 591 153	94
159 300 077	99	161 546 777	138	161 567 009	148	161 591 154	94
159 300 079	99	161 546 782	139	161 567 010	148	161 591 155	94
159 300 085	98	161 546 783	139	161 567 022	148	161 591 156	94
160 050 520	88	161 546 784	139	161 567 023	148	167 514 212	160
160 050 521	88	161 546 785	139	161 567 024	148	167 514 213	160
160 050 522	88	161 546 786	139	161 567 025	148	167 514 214	160
160 050 523	88	161 546 787	139	161 567 026	148	167 514 215	160
160 050 620	88	161 546 792	139	161 567 027	148	167 514 216	160
160 050 621	88	161 546 793	139	161 567 028	148	167 514 217	160
160 050 622	88	161 546 794	139	161 567 029	148	167 514 232	160
160 050 623	88	161 546 795	139	161 567 030	148	167 514 233	160
161 159 157	94	161 546 796	139	161 578 002	149	167 514 234	160
161 159 158	94	161 546 797	139	161 578 003	149	167 514 235	160
161 514 212	147	161 546 805	141	161 578 004	149	167 514 236	160
161 514 213	147	161 546 806	141	161 578 005	149	167 514 237	160
161 514 214	147	161 546 807	141	161 578 006	149	167 514 312	160
161 514 215	147	161 546 815	141	161 578 007	149	167 514 313	160
161 514 216	147	161 546 816	141	161 578 008	149	167 514 314	160
161 514 217	147	161 546 817	141	161 578 009	149	167 514 315	160
161 514 312	147	161 546 822	140	161 578 010	149	167 514 316	160
161 514 313	147	161 546 823	140	161 578 022	149	167 514 317	160
161 514 314	147	161 546 824	140	161 578 023	149	167 514 332	160
161 514 315	147	161 546 825	140	161 578 024	149	167 514 333	160

Index

Code	Page	Code	Page	Code	Page	Code	Page
167 514 334	160	167 546 286	156	167 567 009	161	173 103 177	87
167 514 335	160	167 546 287	156	167 567 010	161	173 103 185	87
167 514 336	160	167 546 288	156	167 567 022	161	173 103 186	87
167 514 337	160	167 546 289	156	167 567 023	161	173 103 187	87
167 543 122	158	167 546 290	156	167 567 024	161	173 103 195	89
167 543 123	158	167 546 292	156	167 567 025	161	173 103 196	89
167 543 124	158	167 546 293	156	167 567 026	161	173 281 925	37
167 543 125	158	167 546 294	156	167 567 027	161	193 017 107	108
167 543 126	158	167 546 295	156	167 567 028	161	193 017 108	108
167 543 127	158	167 546 296	156	167 567 029	161	193 017 109	108
167 543 132	158	167 546 297	156	167 567 030	161	193 017 110	108
167 543 133	158	167 546 298	156	167 567 202	161	193 017 111	108
167 543 134	158	167 546 299	156	167 567 203	161	193 017 112	108
167 543 135	158	167 546 300	156	167 567 204	161	193 017 113	108
167 543 136	158	167 546 308	157	167 567 205	161	193 017 114	108
167 543 137	158	167 546 309	157	167 567 206	161	193 017 115	108
167 543 322	159	167 546 310	157	167 567 207	161	193 017 116	108
167 543 323	159	167 546 318	157	167 567 208	161	193 017 117	108
167 543 324	159	167 546 319	157	167 567 209	161	193 017 118	108
167 543 325	159	167 546 320	157	167 567 210	161	193 017 119	108
167 543 326	159	167 561 266	165	167 578 002	163	193 017 120	108
167 543 327	159	167 561 267	165	167 578 003	163	193 017 121	108
167 543 332	159	167 561 276	165	167 578 004	163	193 017 122	108
167 543 333	159	167 561 277	165	167 578 005	163	193 017 123	108
167 543 334	159	167 561 282	164	167 578 006	163	193 017 124	108
167 543 335	159	167 561 283	164	167 578 007	163	193 017 125	108
167 543 336	159	167 561 284	164	167 578 008	163	193 017 126	108
167 543 337	159	167 561 285	164	167 578 009	163	193 017 127	108
167 546 126	155	167 561 286	164	167 578 010	163	193 017 155	107
167 546 127	155	167 561 287	164	167 578 022	163	193 017 156	107
167 546 136	155	167 561 288	164	167 578 023	163	193 017 157	107
167 546 137	155	167 561 289	164	167 578 024	163	193 017 158	107
167 546 142	154	167 561 290	164	167 578 025	163	193 017 159	107
167 546 143	154	167 561 292	164	167 578 026	163	193 017 160	107
167 546 144	154	167 561 293	164	167 578 027	163	193 017 161	107
167 546 145	154	167 561 294	164	167 578 028	163	193 017 162	107
167 546 146	154	167 561 295	164	167 578 029	163	193 017 163	107
167 546 147	154	167 561 296	164	167 578 030	163	193 017 164	107
167 546 152	154	167 561 297	164	169 543 302	152	193 017 165	107
167 546 153	154	167 562 266	167	169 543 303	152	193 017 166	107
167 546 154	154	167 562 267	167	169 543 304	152	193 017 167	107
167 546 155	154	167 562 276	167	169 543 305	152	193 017 168	107
167 546 156	154	167 562 277	167	169 543 306	152	193 017 169	107
167 546 157	154	167 562 282	166	169 543 307	152	193 017 170	107
167 546 161	157	167 562 283	166	169 543 322	153	193 017 171	107
167 546 162	157	167 562 284	166	169 543 323	153	193 017 172	107
167 546 163	157	167 562 285	166	169 543 324	153	193 017 173	107
167 546 164	157	167 562 286	166	169 543 325	153	193 017 174	107
167 546 165	157	167 562 287	166	169 543 326	153	193 017 175	107
167 546 166	157	167 562 292	166	169 543 327	153	193 017 176	107
167 546 167	157	167 562 293	166	173 103 056	86	193 017 177	107
167 546 171	157	167 562 294	166	173 103 075	87	193 017 203	108
167 546 172	157	167 562 295	166	173 103 076	87	193 017 204	108
167 546 173	157	167 562 296	166	173 103 077	87	193 017 205	108
167 546 174	157	167 562 297	166	173 103 080	86	193 017 206	108
167 546 175	157	167 567 002	161	173 103 081	86	193 017 207	108
167 546 176	157	167 567 003	161	173 103 082	86	193 017 307	106
167 546 177	157	167 567 004	161	173 103 083	86	193 017 308	106
167 546 282	156	167 567 005	161	173 103 084	86	193 017 309	106
167 546 283	156	167 567 006	161	173 103 105	89	193 017 310	106
167 546 284	156	167 567 007	161	173 103 175	87	193 017 311	106
167 546 285	156	167 567 008	161	173 103 176	87	193 017 312	106

Index

Code	Page	Code	Page	Code	Page	Code	Page
193 017 313	106	193 130 087	38	193 130 707	47	193 131 314	52
193 017 314	106	193 130 097	38	193 130 714	47	193 131 317	52
193 017 315	106	193 130 107	38	193 130 717	47	193 131 324	52
193 017 316	106	193 130 117	38	193 130 724	47	193 131 327	52
193 017 317	106	193 130 127	38	193 130 727	47	193 131 334	52
193 017 318	106	193 130 137	38	193 130 734	47	193 131 337	52
193 017 319	106	193 130 147	38	193 130 737	47	193 131 347	52
193 017 320	106	193 130 157	38	193 130 804	48	193 131 357	52
193 017 321	106	193 130 177	38	193 130 814	48	193 131 377	52
193 017 322	106	193 130 234	52	193 130 824	48	193 131 402	44
193 017 323	106	193 130 237	52	193 130 834	48	193 131 403	44
193 017 355	106	193 130 244	52	193 130 837	48	193 131 404	44
193 017 356	106	193 130 247	52	193 130 844	48	193 131 405	44
193 017 357	106	193 130 254	52	193 130 847	48	193 131 412	41
193 017 358	106	193 130 257	52	193 130 854	48	193 131 413	41
193 017 359	106	193 130 264	52	193 130 857	48	193 131 414	41
193 017 360	106	193 130 267	52	193 130 864	48	193 131 422	41
193 017 361	106	193 130 274	52	193 130 867	48	193 131 423	41
193 017 362	106	193 130 277	52	193 130 874	48	193 131 424	41
193 017 363	106	193 130 284	52	193 130 877	48	193 131 432	41
193 017 364	106	193 130 287	52	193 130 884	48	193 131 433	41
193 017 365	106	193 130 294	53	193 130 887	48	193 131 434	41
193 017 366	106	193 130 297	53	193 130 894	48	193 131 437	44
193 017 367	106	193 130 304	53	193 130 897	48	193 131 442	44
193 017 368	106	193 130 307	53	193 130 904	48	193 131 443	44
193 017 369	106	193 130 314	53	193 130 907	48	193 131 444	44
193 017 370	106	193 130 317	53	193 130 914	48	193 131 445	44
193 017 371	106	193 130 324	53	193 130 917	48	193 131 447	44
193 017 372	106	193 130 327	53	193 130 924	48	193 131 452	44
193 017 373	106	193 130 334	53	193 130 927	48	193 131 453	44
193 103 040	85	193 130 337	53	193 130 934	48	193 131 454	44
193 103 042	85	193 130 347	53	193 130 937	48	193 131 455	44
193 103 043	85	193 130 357	53	193 131 037	33	193 131 457	44
193 103 044	85	193 130 377	53	193 131 047	33	193 131 462	44
193 103 045	85	193 130 432	46	193 131 057	33	193 131 463	44
193 103 206	85	193 130 434	46	193 131 067	33	193 131 464	44
193 103 207	85	193 130 452	46	193 131 077	33	193 131 465	44
193 103 208	85	193 130 454	46	193 131 087	33	193 131 467	44
193 103 209	85	193 130 462	46	193 131 097	33	193 131 472	44
193 103 210	85	193 130 464	46	193 131 107	33	193 131 473	44
193 103 211	85	193 130 472	46	193 131 117	33	193 131 474	44
193 103 212	85	193 130 474	46	193 131 127	33	193 131 475	44
193 103 213	85	193 130 492	46	193 131 137	33	193 131 477	44
193 103 214	85	193 130 494	46	193 131 147	33	193 131 482	44
193 104 039	85	193 130 604	47	193 131 157	33	193 131 483	44
193 104 042	85	193 130 614	47	193 131 177	33	193 131 484	44
193 127 017	38	193 130 624	47	193 131 234	52	193 131 485	44
193 127 027	38	193 130 634	47	193 131 237	52	193 131 487	44
193 127 037	38	193 130 637	47	193 131 244	52	193 131 492	44
193 127 047	38	193 130 644	47	193 131 247	52	193 131 493	44
193 127 057	38	193 130 647	47	193 131 254	52	193 131 494	44
193 127 067	38	193 130 654	47	193 131 257	52	193 131 495	44
193 127 077	38	193 130 657	47	193 131 264	52	193 131 497	44
193 127 097	38	193 130 664	47	193 131 267	52	193 131 502	44
193 127 107	38	193 130 667	47	193 131 274	52	193 131 503	44
193 127 117	38	193 130 674	47	193 131 277	52	193 131 504	44
193 127 127	38	193 130 677	47	193 131 284	52	193 131 505	44
193 130 037	38	193 130 684	47	193 131 287	52	193 131 507	44
193 130 047	38	193 130 687	47	193 131 294	52	193 131 512	44
193 130 057	38	193 130 694	47	193 131 297	52	193 131 513	44
193 130 067	38	193 130 697	47	193 131 304	52	193 131 514	44
193 130 077	38	193 130 704	47	193 131 307	52	193 131 515	44

Index

Code	Page	Code	Page	Code	Page	Code	Page
193 131 517	44	193 132 454	42	193 135 009	56	193 135 496	58
193 131 522	44	193 132 455	42	193 135 010	56	193 135 506	58
193 131 523	44	193 132 456	42	193 135 019	56	193 135 676	58
193 131 524	44	193 132 457	42	193 135 020	56	193 135 686	58
193 131 525	45	193 132 462	42	193 135 029	56	193 135 696	58
193 131 527	45	193 132 463	42	193 135 030	56	193 135 698	58
193 131 532	45	193 132 464	42	193 135 039	56	193 135 706	58
193 131 533	45	193 132 465	42	193 135 040	56	193 135 708	58
193 131 534	45	193 132 466	42	193 135 041	56	193 135 716	58
193 131 535	45	193 132 467	42	193 135 049	56	193 135 718	58
193 131 537	45	193 132 472	42	193 135 050	56	193 135 726	58
193 131 547	45	193 132 473	42	193 135 051	56	193 135 728	58
193 131 557	45	193 132 474	42	193 135 059	56	193 135 736	58
193 131 577	45	193 132 475	42	193 135 060	56	193 135 738	58
193 131 632	49	193 132 476	42	193 135 061	56	193 135 746	58
193 131 633	49	193 132 477	42	193 135 069	56	193 135 748	58
193 131 634	49	193 132 482	42	193 135 070	56	193 149 237	39
193 131 867	45	193 132 483	42	193 135 071	56	193 149 247	39
193 131 877	45	193 132 484	42	193 135 079	56	193 149 257	39
193 131 932	40	193 132 485	42	193 135 080	56	193 149 267	39
193 131 933	40	193 132 486	42	193 135 081	56	193 149 277	39
193 131 934	40	193 132 487	42	193 135 159	57	193 149 287	39
193 131 952	40	193 132 492	42	193 135 160	57	193 149 297	39
193 131 953	40	193 132 493	42	193 135 161	57	193 149 307	39
193 131 954	40	193 132 494	42	193 135 174	57	193 149 317	39
193 131 957	40	193 132 495	42	193 135 202	57	193 149 327	39
193 131 962	40	193 132 496	42	193 135 204	57	193 149 337	39
193 131 963	40	193 132 497	42	193 135 212	57	193 149 347	39
193 131 964	40	193 132 502	42	193 135 214	57	193 149 357	39
193 131 967	40	193 132 503	42	193 135 222	57	193 149 377	39
193 131 972	40	193 132 504	42	193 135 224	57	193 149 437	39
193 131 973	40	193 132 505	42	193 135 232	57	193 149 447	39
193 131 974	40	193 132 506	42	193 135 234	57	193 149 457	39
193 131 977	40	193 132 507	42	193 135 242	57	193 149 467	39
193 131 992	40	193 132 512	43	193 135 244	57	193 149 477	39
193 131 993	40	193 132 513	43	193 135 252	57	193 149 487	39
193 131 994	40	193 132 514	43	193 135 254	57	193 149 497	39
193 131 997	40	193 132 515	43	193 135 262	57	193 149 507	39
193 132 402	42	193 132 516	43	193 135 264	57	193 149 517	39
193 132 403	42	193 132 517	43	193 135 272	57	193 149 527	39
193 132 404	42	193 132 522	43	193 135 282	57	193 149 537	39
193 132 405	42	193 132 523	43	193 135 284	57	193 149 547	39
193 132 412	41	193 132 524	43	193 135 289	57	193 149 557	39
193 132 413	41	193 132 525	43	193 135 290	57	193 149 577	39
193 132 414	41	193 132 526	43	193 135 291	57	193 155 034	50
193 132 422	41	193 132 527	43	193 135 294	57	193 155 035	50
193 132 423	41	193 132 532	43	193 135 304	57	193 155 036	50
193 132 424	41	193 132 533	43	193 135 309	57	193 155 037	50
193 132 432	41	193 132 534	43	193 135 310	57	193 155 044	50
193 132 433	41	193 132 535	43	193 135 311	57	193 155 045	50
193 132 434	41	193 132 536	43	193 135 329	57	193 155 046	50
193 132 435	41	193 132 537	43	193 135 330	57	193 155 047	50
193 132 436	42	193 132 544	43	193 135 331	57	193 155 054	50
193 132 437	42	193 132 545	43	193 135 339	57	193 155 055	50
193 132 442	42	193 132 546	43	193 135 340	57	193 155 056	50
193 132 443	42	193 132 547	43	193 135 341	57	193 155 057	50
193 132 444	42	193 132 554	43	193 135 346	58	193 155 064	50
193 132 445	42	193 132 555	43	193 135 446	58	193 155 065	50
193 132 446	42	193 132 556	43	193 135 456	58	193 155 066	50
193 132 447	42	193 132 557	43	193 135 466	58	193 155 067	50
193 132 452	42	193 133 067	33	193 135 476	58	193 155 074	50
193 132 453	42	193 133 097	33	193 135 486	58	193 155 075	50

Index

Code	Page	Code	Page	Code	Page	Code	Page
193 155 076	50	193 280 153	34	193 281 163	46	316 400 010	203
193 155 077	50	193 280 154	34	193 281 164	46	700 647 600	124
193 155 084	50	193 280 184	33	193 281 434	45	700 647 601	124
193 155 085	51	193 280 185	33	193 281 435	46	700 647 602	124
193 155 086	51	193 280 272	35	193 281 437	46	700 647 603	124
193 155 087	51	193 280 273	35	193 281 438	46	700 647 604	124
193 155 094	51	193 280 274	35	193 281 439	46	700 647 605	124
193 155 095	51	193 280 279	35	193 281 459	40	700 647 606	124
193 155 096	51	193 280 290	33	193 281 605	34	700 647 607	124
193 155 097	51	193 280 294	35	193 281 606	34	700 647 608	124
193 155 104	51	193 280 300	34	193 281 617	37	700 647 609	124
193 155 105	51	193 280 301	34	193 480 086	168	700 647 610	124
193 155 106	51	193 280 358	33	193 480 087	168	700 647 611	124
193 155 107	51	193 280 359	33	193 480 088	168	700 647 612	124
193 155 114	51	193 280 360	33	193 480 102	168	700 647 613	124
193 155 115	51	193 280 711	33	193 480 103	168	700 647 614	124
193 155 116	51	193 280 880	56	193 480 104	168	700 647 615	124
193 155 117	51	193 280 881	56	193 480 105	168	700 647 616	124
193 155 124	51	193 280 951	25	193 480 106	168	700 647 617	124
193 155 125	51	193 280 952	25	193 480 107	168	700 647 618	124
193 155 126	51	193 280 953	25	193 480 152	169	700 647 619	124
193 155 127	51	193 280 958	25	193 480 153	169	700 647 620	124
193 155 134	51	193 280 959	25	193 480 154	169	700 647 621	124
193 155 135	51	193 280 961	22	193 480 155	169	700 647 622	124
193 155 136	51	193 280 963	22	193 480 156	169	700 647 623	124
193 155 137	51	193 280 965	22	193 480 157	169	700 647 624	124
193 155 144	51	193 280 992	25	193 480 158	169	700 647 625	124
193 155 145	51	193 280 993	25	193 480 159	169	700 647 626	124
193 155 146	51	193 280 994	25	193 480 160	169	700 647 627	124
193 155 147	51	193 280 995	25	193 480 168	169	700 647 628	124
193 155 154	51	193 280 996	25	193 480 169	169	700 647 629	124
193 155 155	51	193 280 997	23	193 480 170	169	700 647 630	124
193 155 156	51	193 280 998	22	193 480 175	168	700 647 631	124
193 155 157	51	193 280 999	22	193 480 176	168	700 647 632	124
193 155 234	49	193 281 004	22	193 480 177	168	700 647 633	124
193 155 237	49	193 281 005	22	193 480 178	168	700 647 634	124
193 155 244	49	193 281 006	23	193 480 179	168	700 647 635	124
193 155 247	49	193 281 007	23	193 480 180	168	700 647 636	124
193 155 254	49	193 281 008	23	193 480 181	168	700 647 637	124
193 155 257	49	193 281 009	23	316 110 022	203	700 647 638	124
193 155 264	49	193 281 010	23	316 110 039	203	700 647 639	124
193 155 267	49	193 281 011	23	316 125 029	203	700 647 640	124
193 155 274	49	193 281 012	23	316 125 031	203	700 647 641	125
193 155 277	49	193 281 013	23	316 140 018	203	700 647 642	125
193 155 284	49	193 281 027	56	316 140 027	203	700 647 643	125
193 155 287	49	193 281 030	23	316 160 019	203	700 647 644	125
193 155 294	49	193 281 031	23	316 160 020	203	700 647 645	125
193 155 297	49	193 281 032	22	316 180 019	203	700 647 646	125
193 155 304	49	193 281 033	22	316 180 020	203	700 647 647	125
193 155 307	49	193 281 113	45	316 200 012	203	700 647 648	125
193 155 314	49	193 281 122	46	316 200 014	203	700 647 649	125
193 155 317	49	193 281 152	45	316 225 009	203	700 647 650	125
193 155 324	49	193 281 153	45	316 225 010	203	700 647 651	125
193 155 327	49	193 281 154	46	316 250 005	203	700 647 652	125
193 155 334	50	193 281 155	46	316 250 009	203	700 647 653	125
193 155 337	49	193 281 156	46	316 280 019	203	700 647 654	125
193 155 344	50	193 281 157	46	316 280 024	203	700 647 655	125
193 155 347	50	193 281 158	46	316 315 008	203	700 647 656	125
193 155 354	50	193 281 159	46	316 315 009	203	700 647 657	125
193 155 357	50	193 281 160	46	316 355 017	203	700 647 658	125
193 155 374	50	193 281 161	46	316 355 020	203	700 647 659	125
193 155 377	50	193 281 162	46	316 400 008	203	700 647 660	125

Index

Code	Page	Code	Page	Code	Page	Code	Page
700 647 661	125	700 665 188	126	700 665 288	130	701 480 480	188
700 647 662	125	700 665 189	126	700 665 289	130	701 480 481	188
700 647 663	125	700 665 190	126	700 665 290	130	701 480 482	188
700 647 664	125	700 665 191	126	700 665 291	130	701 480 483	188
700 647 665	125	700 665 192	126	700 665 292	130	701 480 489	187
700 647 666	125	700 665 193	126	700 665 293	130	701 480 490	187
700 647 667	125	700 665 194	126	700 665 294	130	701 480 491	187
700 647 668	125	700 665 195	126	700 665 295	130	701 480 492	187
700 647 669	125	700 665 196	126	700 665 296	130	701 480 493	187
700 647 670	125	700 665 197	126	700 665 297	130	701 480 494	187
700 647 671	125	700 665 198	126	700 665 425	132	720 100 007	31
700 647 672	125	700 665 199	126	700 665 426	132	720 100 008	31
700 647 673	125	700 665 200	126	700 665 427	132	720 100 010	31
700 647 674	125	700 665 201	126	700 665 428	132	720 100 011	31
700 647 675	125	700 665 202	126	700 665 429	132	720 100 018	31
700 647 676	125	700 665 203	131	700 665 430	132	720 100 021	31
700 647 677	125	700 665 204	131	700 665 431	132	720 100 258	30
700 647 678	125	700 665 205	131	700 665 432	132	720 100 259	30
700 647 679	125	700 665 206	131	700 665 433	132	720 100 260	30
700 647 680	125	700 665 207	131	700 665 434	132	720 100 261	30
700 647 681	125	700 665 208	131	700 665 435	132	720 100 281	30
700 647 682	125	700 665 209	131	700 665 436	132	720 100 282	30
700 647 683	125	700 665 210	131	700 665 437	132	720 100 283	30
700 647 684	125	700 665 211	131	700 665 438	132	720 100 756	30
700 647 685	125	700 665 212	131	700 665 439	132	720 100 757	30
700 647 686	125	700 665 213	131	700 665 462	131	720 100 758	30
700 647 687	125	700 665 214	131	700 665 463	131	720 100 759	30
700 647 688	125	700 665 215	131	700 665 464	131	720 100 760	30
700 647 689	125	700 665 216	131	700 665 465	131	720 100 761	30
700 647 690	125	700 665 217	131	700 665 466	131	720 100 766	30
700 647 691	125	700 665 218	131	700 665 467	131	720 100 767	30
700 647 692	126	700 665 219	131	700 665 468	131	720 100 771	30
700 647 693	126	700 665 220	131	700 665 469	131	720 100 772	30
700 647 694	126	700 665 221	131	700 665 470	131	720 100 776	30
700 647 695	126	700 665 260	126	700 665 471	131	720 100 777	30
700 647 696	126	700 665 261	126	700 665 472	131	720 100 782	30
700 647 697	126	700 665 262	126	700 665 473	131	720 100 783	30
700 647 698	126	700 665 263	126	700 665 474	131	720 910 007	27
700 647 699	126	700 665 264	126	700 665 475	131	720 910 008	27
700 647 886	189	700 665 265	126	700 665 476	131	720 910 010	27
700 647 887	189	700 665 266	126	701 474 382	188	720 910 011	27
700 647 888	189	700 665 267	126	701 474 383	187	720 910 021	27
700 647 889	189	700 665 268	126	701 474 386	188	720 910 028	27
700 647 890	189	700 665 269	126	701 474 387	188	720 920 007	36
700 647 891	189	700 665 270	126	701 474 388	187	720 920 008	36
700 647 892	189	700 665 271	126	701 474 390	188	720 920 010	36
700 647 893	189	700 665 272	127	701 474 391	188	720 920 011	36
700 647 894	189	700 665 273	127	701 474 392	188	720 920 018	36
700 647 895	189	700 665 274	127	701 474 393	188	720 920 021	36
700 647 896	189	700 665 275	127	701 474 394	188	720 920 208	36
700 647 897	189	700 665 276	127	701 474 395	188	720 920 209	36
700 647 898	189	700 665 277	127	701 474 396	188	720 920 210	36
700 647 899	189	700 665 278	127	701 474 397	188	720 920 211	36
700 647 900	189	700 665 279	130	701 474 398	188	720 920 221	36
700 647 901	189	700 665 280	130	701 474 399	187	720 920 231	36
700 647 902	189	700 665 281	130	701 474 400	187	720 920 241	36
700 647 903	189	700 665 282	130	701 474 401	187	720 920 258	28
700 647 904	189	700 665 283	130	701 480 475	188	720 920 259	28
700 665 184	126	700 665 284	130	701 480 476	188	720 920 260	28
700 665 185	126	700 665 285	130	701 480 477	188	720 920 261	28
700 665 186	126	700 665 286	130	701 480 478	188	720 920 281	28
700 665 187	126	700 665 287	130	701 480 479	188	720 920 282	28

Index

Code	Page	Code	Page	Code	Page	Code	Page
720 920 283	28	724 700 430	186	727 700 419	194	733 100 109	109
720 920 706	35	724 700 431	186	727 700 420	194	733 100 110	109
720 920 707	35	724 700 432	186	727 700 513	184	733 100 111	109
720 920 708	35	724 705 026	186, 187, 188	727 700 514	184	733 100 112	109
720 920 709	36	724 705 130	188	727 700 515	184	733 100 113	109
720 920 710	36	724 705 131	188	727 700 516	184	733 100 114	109
720 920 711	36	724 705 132	188	727 700 517	184, 184	733 100 206	113
720 920 718	35	724 705 133	188	727 700 518	184	733 100 207	113
720 920 719	35	724 705 134	188	727 700 519	184, 184	733 100 208	113
720 920 720	36	724 920 206	37	727 700 520	184, 185	733 100 209	113
720 920 721	36	724 920 207	37	727 700 521	184	733 150 106	109
720 920 728	35	724 920 208	37	727 700 522	184	733 150 107	109
720 920 729	36	724 920 209	37	727 700 523	184	733 150 108	109
720 920 730	36	724 920 210	37	727 700 524	184	733 150 109	109
720 920 731	36	724 920 211	37	727 700 525	184	733 150 110	109
720 920 754	28	724 920 256	27	727 700 716	185	733 150 111	109
720 920 756	28	724 920 257	27	727 700 717	185, 187	733 150 112	109
720 920 757	28	724 920 258	27	727 700 718	185	733 150 113	109
720 920 758	28	724 920 259	27	727 700 719	185, 187	733 150 114	109
720 920 759	28	724 920 260	27	727 700 720	185, 187	733 200 106	109
720 920 760	28	724 920 261	27	727 700 721	185	733 200 107	109
720 920 761	28	724 920 262	27	727 700 722	185	733 200 108	109
720 920 763	28	724 920 706	36	727 700 723	185	733 200 109	109
720 920 764	28	724 920 707	36	727 700 724	185	733 200 110	109
720 920 765	28	724 920 708	36	727 700 725	185	733 200 111	109
720 920 766	28	724 920 709	36	727 700 819	194	733 200 112	109
720 920 767	28	724 920 710	37	727 700 820	194	733 200 113	109
720 920 768	28	724 920 711	37	727 701 206	187, 194	733 200 114	109
720 920 771	28	724 920 719	37	727 701 207	187, 194	733 310 006	114
720 920 772	28	724 920 721	37	727 701 208	187, 194	733 310 007	114
720 920 773	28	724 920 756	27	727 701 209	187, 194	733 310 008	114
720 920 776	28	724 920 757	27	727 701 210	187, 194	733 310 009	114
720 920 777	28	724 920 758	27	727 701 211	187, 194	733 310 010	114
720 920 778	28	724 920 759	27	727 701 212	187, 194	733 310 011	114
720 920 781	28	724 920 760	27	727 701 213	194	733 310 036	114
720 920 782	28	724 920 761	27	727 701 214	194	733 310 037	114
720 920 783	28	724 920 771	27	727 701 313	187	733 310 038	114
724 100 256	29	724 920 772	27	727 701 314	187	733 310 039	114
724 100 257	29	727 690 442	135	727 701 321	187	733 310 040	114
724 100 258	29	727 690 443	135	727 701 322	187	733 310 041	114
724 100 259	29	727 700 206	185, 193	727 701 323	187	733 580 106	111
724 100 260	29	727 700 207	185, 193	727 701 324	187	733 580 107	111
724 100 261	29	727 700 208	185, 193	727 701 325	187	733 580 108	111
724 100 756	29	727 700 209	185, 193	727 701 406	184, 194	733 580 109	111
724 100 757	29	727 700 210	185, 193	727 701 407	184, 194	733 580 110	111
724 100 758	29	727 700 211	185, 193	727 701 408	184, 194	733 580 111	111
724 100 759	29	727 700 212	185, 193	727 701 409	184, 194	733 580 206	111
724 100 760	29	727 700 213	193	727 701 410	184, 194	733 580 207	111
724 100 761	29	727 700 214	193	727 701 411	184, 194	733 580 208	111
724 100 771	29	727 700 313	185	727 701 412	184, 194	733 580 209	111
724 100 772	29	727 700 314	185	727 701 413	194	733 580 210	111
724 700 319	186	727 700 315	185	727 701 414	194	733 580 211	111
724 700 320	186	727 700 406	184, 193	727 701 422	194	733 580 706	111
724 700 321	186	727 700 407	184, 193	727 701 423	194	733 580 707	111
724 700 322	186	727 700 408	184, 193	727 701 513	184	733 580 708	111
724 700 323	186	727 700 409	184, 193	727 701 514	184	733 580 709	111
724 700 324	186	727 700 410	184, 193	727 701 521	185	733 580 710	111
724 700 325	186	727 700 411	184, 193	727 701 522	185	733 580 711	111
724 700 426	186	727 700 412	184, 193	727 701 523	185	733 690 406	135
724 700 427	186	727 700 413	193	733 100 106	109	733 690 407	135
724 700 428	186	727 700 414	193	733 100 107	109	733 690 408	135
724 700 429	186	727 700 417	194	733 100 108	109	733 690 409	135

Index

Code	Page	Code	Page	Code	Page	Code	Page
733 690 410	135	733 910 353	110	748 400 013	197	748 440 706	195, 196, 198
733 690 411	135	733 910 358	110	748 400 305	195, 197	748 440 707	195, 196, 198
733 800 009	192	733 910 359	110	748 400 306	195, 197	748 440 708	195, 196, 198
733 800 010	192	733 910 360	110	748 400 307	195, 197	748 440 709	195, 196, 198
733 800 011	192	733 910 361	110	748 400 308	195, 197	748 440 710	195, 196, 198
733 800 012	192	733 910 362	110	748 400 309	195, 197	748 440 711	195, 196, 198
733 800 013	192	733 910 364	110	748 400 310	195, 197	748 440 712	195, 196, 198
733 800 014	192	733 910 370	110	748 400 311	195, 197	748 440 713	195, 196, 198
733 808 009	181	733 910 371	110	748 400 312	195, 197	748 440 714	198
733 808 010	181	733 910 376	110	748 400 313	195, 197	748 440 715	198
733 808 011	181	733 910 434	113	748 400 314	195, 197	748 440 716	198
733 808 012	181	733 910 437	113	748 400 315	197	748 440 717	198
733 808 013	181	733 910 441	113	748 400 316	197	748 440 719	198
733 808 014	181	733 910 446	113	748 400 317	197	748 440 720	198
733 808 016	181	733 910 452	113	748 400 319	197	748 440 721	198
733 808 017	181	733 960 106	110	748 400 320	197	748 440 722	198
733 808 020	181	733 960 107	110	748 400 321	197	748 440 723	198
733 808 022	181	733 960 108	110	748 400 322	197	748 440 724	198
733 808 023	181	733 960 109	110	748 400 323	197	748 440 725	198
733 808 034	181	733 960 110	110	748 400 330	198	748 440 726	198
733 808 035	181	733 960 111	110	748 400 331	198	748 440 727	198
733 808 036	181	733 960 112	110	748 400 332	198	748 440 728	198
733 808 037	181	733 960 113	110	748 400 333	198	748 440 729	198
733 808 038	181	733 960 114	110	748 410 000	112, 196	749 400 005	197
733 808 039	181	734 600 106	112	748 410 001	112, 196	749 400 006	197
733 808 041	181	734 600 107	112	748 410 002	112, 196	749 400 007	197
733 808 042	181	734 600 108	112	748 410 003	112, 196	749 400 008	197
733 808 045	181	734 600 109	112	748 410 004	136	749 400 009	197
733 808 047	181	734 600 110	112	748 410 005	136	749 400 010	197
733 808 048	181	734 600 111	112	748 410 006	136	749 400 011	197
733 810 106	191	745 440 706	196, 199	748 410 007	112, 136, 196	749 400 012	197
733 810 107	191	745 440 707	196, 199	748 410 008	136	749 400 013	197
733 810 108	191	745 440 708	196, 199	748 410 009	136	749 410 000	112, 196
733 810 109	191	745 440 709	196, 199	748 410 010	136	749 410 001	112, 196
733 810 110	191	745 440 710	196, 199	748 410 011	136	749 410 002	112, 196
733 810 111	191	745 440 711	196, 199	748 410 012	112, 196	749 410 003	112, 196
733 810 112	191	745 440 712	196, 199	748 410 013	112, 196	749 410 004	136
733 810 113	191	745 440 713	196, 199	748 410 014	112, 136, 196	749 410 005	136
733 810 114	191	745 440 714	196, 199	748 410 015	112, 136, 196	749 410 006	112, 136, 196
733 900 006	107	745 440 715	199	748 410 016	112, 136, 196	749 410 007	112, 136, 196
733 900 007	107	745 440 716	199	748 410 248	136	749 410 008	136
733 910 106	110	745 440 717	199	748 440 502	199	749 410 009	136
733 910 107	110	745 440 719	199	748 440 503	199	749 410 010	136
733 910 108	110	745 440 720	199	748 440 504	199	749 410 011	136
733 910 109	110	745 440 721	199	748 440 505	199	749 410 012	112, 196
733 910 110	110	745 440 722	199	748 440 506	199	749 410 013	112, 196
733 910 111	110	745 440 723	199	748 440 507	199	749 410 014	112, 136, 196
733 910 112	110	745 440 724	199	748 440 508	199	749 410 015	112, 136, 196
733 910 113	110	745 440 725	199	748 440 509	199	749 410 016	112, 136, 196
733 910 114	110	745 440 726	199	748 440 512	199	749 410 174	112
733 910 206	113	745 440 727	199	748 440 515	199		
733 910 207	113	745 440 728	199	748 440 517	199		
733 910 208	113	745 440 729	199	748 440 518	199		
733 910 209	113	748 400 004	197	748 440 519	199		
733 910 210	113	748 400 005	197	748 440 520	199		
733 910 211	113	748 400 006	197	748 440 521	199		
733 910 337	110	748 400 007	197	748 440 522	199		
733 910 341	110	748 400 008	197	748 440 705	195, 198		
733 910 346	110	748 400 009	197				
733 910 347	110	748 400 010	197				
733 910 348	110	748 400 011	197				
733 910 352	110	748 400 012	197				

Index

Code	Page	Code	Page	Code	Page	Code	Page
749 410 248	136	753 000 826	65	753 018 716	116	753 060 820	69
749 440 502	199	753 000 827	65	753 018 717	116	753 060 821	69
749 440 503	199	753 000 828	66	753 018 718	116	753 060 822	69
749 440 504	199	753 000 829	66	753 018 719	116	753 060 823	69
749 440 505	199	753 000 830	66	753 018 720	116	753 060 824	69
749 440 506	199	753 000 831	66	753 018 737	116	753 060 825	69
749 440 507	199	753 001 008	65	753 018 738	116	753 060 826	69
749 440 508	199	753 001 009	65	753 018 739	116	753 060 827	69
749 440 509	199	753 001 010	65	753 020 824	116	753 060 828	69
749 440 512	199	753 001 011	65	753 020 825	116	753 060 829	69
749 440 515	199	753 001 012	65	753 020 826	116	753 061 008	69
749 440 517	199	753 001 013	65	753 020 827	116	753 061 009	69
749 440 518	199	753 001 014	65	753 021 024	116	753 061 010	69
749 440 519	199	753 001 015	65	753 021 025	116	753 061 011	69
749 440 520	199	753 001 016	65	753 021 026	116	753 061 012	69
749 440 521	199	753 001 017	65	753 021 027	116	753 061 013	69
749 440 522	199	753 001 018	65	753 050 813	68	753 061 014	69
749 440 705	195, 198	753 001 019	65	753 050 814	68	753 061 015	69
749 440 706	195, 196, 198	753 001 020	65	753 050 815	68	753 061 016	69
749 440 707	195, 196, 198	753 001 021	65	753 050 816	68	753 061 017	69
749 440 708	195, 196, 198	753 001 022	65	753 050 817	68	753 061 018	69
749 440 709	195, 196, 198	753 001 023	65	753 050 818	68	753 061 019	69
749 440 710	195, 196, 198	753 001 024	65	753 050 819	68	753 061 020	69
749 440 711	195, 196, 198	753 001 025	65	753 050 820	68	753 061 021	69
749 440 712	195, 196, 198	753 001 026	65	753 050 821	68	753 061 022	69
749 440 713	195, 196, 198	753 001 027	65	753 050 822	68	753 061 023	69
749 440 714	195, 198	753 001 028	65	753 050 823	68	753 061 024	69
749 440 715	198	753 001 029	65	753 050 824	68	753 061 025	69
749 440 716	198	753 001 030	65	753 050 825	68	753 061 026	69
749 440 717	198	753 001 031	65	753 050 826	68	753 061 027	69
749 440 719	198	753 002 001	66	753 050 827	68	753 061 028	69
749 440 720	198	753 002 002	66	753 050 828	68	753 061 029	69
749 440 721	198	753 002 003	66	753 050 829	68	753 070 813	67
749 440 722	198	753 002 004	66	753 051 008	67	753 070 814	67
749 440 723	198	753 003 001	68	753 051 009	67	753 070 815	67
749 440 724	198	753 003 002	68	753 051 010	67	753 070 816	67
749 440 725	198	753 003 003	68	753 051 011	67	753 070 817	67
749 440 726	198	753 003 004	68	753 051 012	67	753 070 818	67
749 440 727	198	753 018 515	116	753 051 013	67	753 070 819	67
749 440 728	198	753 018 516	116	753 051 014	67	753 070 820	67
749 440 729	198	753 018 517	116	753 051 015	67	753 070 821	67
753 000 813	65	753 018 518	116	753 051 016	67	753 070 822	67
753 000 814	65	753 018 519	116	753 051 017	67	753 070 823	67
753 000 815	65	753 018 520	116	753 051 018	67	753 070 824	67
753 000 816	65	753 018 521	116	753 051 019	67	753 070 825	67
753 000 817	65	753 018 522	116	753 051 020	67	753 070 826	67
753 000 818	65	753 018 523	116	753 051 021	67	753 070 827	67
753 000 819	65	753 018 621	116	753 051 022	67	753 070 828	67
753 000 820	65	753 018 622	116	753 051 023	67	753 070 829	67
753 000 821	65	753 018 623	116	753 051 024	67	753 071 008	66
753 000 822	65	753 018 635	116	753 051 025	67	753 071 009	66
753 000 823	65	753 018 636	116	753 051 026	67	753 071 010	66
753 000 824	65	753 018 706	116	753 051 027	67	753 071 011	66
753 000 825	65	753 018 707	116	753 051 028	67	753 071 012	66
		753 018 708	116	753 051 029	67	753 071 013	66
		753 018 709	116	753 060 813	69	753 071 014	66
		753 018 710	116	753 060 814	69	753 071 015	66
		753 018 711	116	753 060 815	69	753 071 016	66
		753 018 712	116	753 060 816	69	753 071 017	66
		753 018 713	116	753 060 817	69	753 071 018	66
		753 018 714	116	753 060 818	69	753 071 019	66
		753 018 715	116	753 060 819	69	753 071 020	66

Index

Code	Page	Code	Page	Code	Page	Code	Page
753 071 021	66	753 090 827	71	753 101 814	19	753 141 019	64
753 071 022	66	753 090 828	71	753 101 815	19	753 141 020	64
753 071 023	66	753 090 829	71	753 101 817	19	753 141 021	64
753 071 024	66	753 091 008	71	753 101 818	19	753 141 022	64
753 071 025	66	753 091 009	71	753 101 819	19	753 141 023	64
753 071 026	66	753 091 010	71	753 101 820	19	753 150 813	62
753 071 027	66	753 091 011	71	753 101 821	19	753 150 814	62
753 071 028	66	753 091 012	71	753 108 606	117	753 150 815	62
753 071 029	66	753 091 013	71	753 108 607	117	753 150 816	62
753 080 813	70	753 091 014	71	753 108 608	117	753 150 817	62
753 080 814	70	753 091 015	71	753 108 609	117	753 150 818	62
753 080 815	70	753 091 016	71	753 108 610	117	753 150 819	62
753 080 816	70	753 091 017	71	753 108 611	117	753 150 820	62
753 080 817	70	753 091 018	71	753 120 813	63	753 150 821	62
753 080 818	70	753 091 019	71	753 120 814	63	753 150 822	62
753 080 819	70	753 091 020	71	753 120 815	63	753 150 823	62
753 080 820	70	753 091 021	71	753 120 816	63	753 150 922	62
753 080 821	70	753 091 022	71	753 120 817	63	753 150 923	62
753 080 822	70	753 091 023	71	753 120 818	63	753 151 006	62
753 080 823	70	753 091 024	71	753 120 819	63	753 151 007	62
753 080 824	70	753 091 025	71	753 120 820	63	753 151 008	62
753 080 825	70	753 091 026	71	753 120 821	63	753 151 009	62
753 080 826	70	753 091 027	71	753 120 822	63	753 151 010	62
753 080 827	70	753 091 028	71	753 120 823	63	753 151 011	62
753 080 828	70	753 091 029	71	753 120 908	63	753 151 012	62
753 080 829	70	753 100 813	61	753 120 909	63	753 151 013	62
753 081 008	70	753 100 814	61	753 120 910	63	753 151 014	62
753 081 009	70	753 100 815	61	753 120 911	63	753 151 015	62
753 081 010	70	753 100 816	61	753 120 912	63	753 151 016	62
753 081 011	70	753 100 817	61	753 120 913	63	753 151 017	62
753 081 012	70	753 100 818	61	753 120 914	63	753 151 018	62
753 081 013	70	753 100 819	61	753 120 915	63	753 151 019	62
753 081 014	70	753 100 820	61	753 120 916	63	753 151 020	62
753 081 015	70	753 100 821	61	753 120 917	63	753 151 021	62
753 081 016	70	753 100 822	61	753 120 918	63	753 151 608	20
753 081 017	70	753 100 823	61	753 120 919	63	753 151 609	20
753 081 018	70	753 100 922	61	753 120 920	63	753 151 610	20
753 081 019	70	753 100 923	61	753 120 921	63	753 151 611	20
753 081 020	70	753 101 001	61	753 120 922	63	753 151 612	20
753 081 021	70	753 101 006	61	753 120 923	63	753 151 813	20
753 081 022	70	753 101 007	61	753 140 813	64	753 151 814	20
753 081 023	70	753 101 008	61	753 140 814	64	753 151 815	20
753 081 024	70	753 101 009	61	753 140 815	64	753 151 817	20
753 081 025	70	753 101 010	61	753 140 816	64	753 151 818	20
753 081 026	70	753 101 011	61	753 140 817	64	753 151 819	20
753 081 027	70	753 101 012	61	753 140 818	64	753 151 820	20
753 081 028	70	753 101 013	61	753 140 819	64	753 151 821	20
753 081 029	70	753 101 014	61	753 140 820	64	753 158 412	117
753 090 813	71	753 101 015	61	753 140 821	64	753 158 413	117
753 090 814	71	753 101 016	61	753 140 822	64	753 158 414	117
753 090 815	71	753 101 017	61	753 140 823	64	753 158 535	117
753 090 816	71	753 101 018	61	753 141 008	64	753 158 536	117
753 090 817	71	753 101 019	61	753 141 009	64	753 158 540	117
753 090 818	71	753 101 020	61	753 141 010	64	753 158 541	117
753 090 819	71	753 101 606	19	753 141 011	64	753 158 542	117
753 090 820	71	753 101 607	19	753 141 012	64	753 158 544	117
753 090 821	71	753 101 608	19	753 141 013	64	753 158 545	117
753 090 822	71	753 101 609	19	753 141 014	64	753 158 606	117
753 090 823	71	753 101 610	19	753 141 015	64	753 158 607	117
753 090 824	71	753 101 611	19	753 141 016	64	753 158 608	117
753 090 825	71	753 101 612	19	753 141 017	64	753 158 609	117
753 090 826	71	753 101 813	19	753 141 018	64	753 158 610	117

Index

Code	Page	Code	Page	Code	Page	Code	Page
753 158 611	117	753 200 851	76	753 201 040	74	753 201 609	23
753 158 612	117	753 200 852	76	753 201 041	74	753 201 610	23
753 158 613	117	753 200 853	76	753 201 042	74	753 201 611	23
753 158 614	117	753 200 854	76	753 201 043	74	753 201 613	23
753 158 615	117	753 200 855	76, 77	753 201 048	74	753 201 614	23
753 158 616	117	753 200 856	77	753 201 049	74	753 201 615	23
753 158 617	117	753 200 857	77	753 201 050	74	753 201 617	23
753 158 619	117	753 200 858	77	753 201 051	75	753 201 618	23
753 158 620	117	753 200 859	77	753 201 052	75	753 201 813	21
753 200 024	72	753 200 860	77	753 201 053	75	753 201 814	21
753 200 025	72	753 200 861	77	753 201 054	75	753 201 815	21
753 200 026	72	753 200 862	77	753 201 055	74	753 201 817	21
753 200 027	72	753 200 863	77	753 201 069	75	753 201 818	21
753 200 124	72	753 200 864	77	753 201 070	75	753 201 819	21
753 200 125	72	753 200 865	77	753 201 072	75	753 201 820	21
753 200 126	73	753 200 866	77	753 201 073	74	753 201 821	21
753 200 127	73	753 200 867	77	753 201 074	74	753 201 827	76
753 200 801	77	753 200 868	77	753 201 075	74	753 201 873	76
753 200 802	72	753 200 869	77	753 201 076	74	753 201 874	76
753 200 803	72	753 200 870	77	753 201 077	75	753 201 875	76
753 200 808	73	753 200 902	72	753 201 078	74	753 201 876	76
753 200 809	73	753 200 903	72	753 201 079	74	753 201 878	76
753 200 810	77	753 200 908	72	753 201 080	75	753 201 879	76
753 200 811	77	753 200 909	72	753 201 081	75	753 201 920	73
753 200 812	77	753 201 001	72	753 201 082	75	753 201 921	73
753 200 813	72	753 201 002	75	753 201 084	75	753 202 810	73
753 200 814	72	753 201 003	75	753 201 085	75	753 202 811	73
753 200 815	72	753 201 004	75	753 201 086	75	753 202 812	73
753 200 816	72	753 201 005	75	753 201 087	75	753 202 813	73
753 200 817	72	753 201 006	72	753 201 089	75	753 208 301	119
753 200 818	72	753 201 007	72	753 201 090	75	753 208 302	119
753 200 819	72	753 201 008	72	753 201 091	75	753 208 303	119
753 200 820	72	753 201 009	72	753 201 092	75	753 208 304	119
753 200 821	72	753 201 010	72	753 201 093	75	753 208 305	119
753 200 822	77	753 201 011	72	753 201 094	75	753 208 307	119
753 200 823	77	753 201 012	72	753 201 095	75	753 208 308	119
753 200 824	77	753 201 013	72	753 201 096	75	753 208 309	119
753 200 825	77	753 201 014	72	753 201 097	75	753 208 310	119
753 200 826	77	753 201 015	72	753 201 098	75	753 208 311	119
753 200 827	77	753 201 016	72	753 201 099	75	753 208 312	119
753 200 828	76	753 201 017	72	753 201 100	75	753 208 313	119
753 200 829	76	753 201 018	72	753 201 101	75	753 208 314	119
753 200 831	76	753 201 019	72	753 201 102	75	753 208 321	119
753 200 832	76	753 201 020	72	753 201 103	75	753 208 322	119
753 200 833	76	753 201 021	74	753 201 104	75	753 208 323	119
753 200 834	76	753 201 022	74	753 201 105	75	753 208 324	119
753 200 835	76	753 201 023	74	753 201 106	75	753 208 338	119
753 200 836	76	753 201 024	74	753 201 107	75	753 208 339	119
753 200 837	76	753 201 025	74	753 201 108	75	753 208 341	119
753 200 838	76	753 201 026	74	753 201 109	75	753 208 351	118
753 200 839	76	753 201 027	74	753 201 110	75	753 208 352	118
753 200 840	76	753 201 028	74	753 201 111	75	753 208 353	118
753 200 841	76	753 201 029	74	753 201 112	76	753 208 354	118
753 200 842	76	753 201 031	74	753 201 113	76	753 208 355	118
753 200 843	76	753 201 032	74	753 201 114	76	753 208 357	118
753 200 844	76	753 201 033	74	753 201 115	76	753 208 358	118
753 200 845	77	753 201 034	74	753 201 116	75	753 208 359	118
753 200 846	77	753 201 035	74	753 201 120	72	753 208 360	118
753 200 847	77	753 201 036	74	753 201 121	72	753 208 361	118
753 200 848	77	753 201 037	74	753 201 606	23	753 208 362	118
753 200 849	77	753 201 038	74	753 201 607	23	753 208 363	118
753 200 850	77	753 201 039	74	753 201 608	23	753 208 364	118

Index

Code	Page	Code	Page	Code	Page	Code	Page
753 208 371	118	753 211 608	21	753 518 609	133	753 665 584	115
753 208 372	118	753 211 609	21	753 518 610	133	753 665 585	115
753 208 373	118	753 211 610	21	753 518 611	133	753 665 586	115
753 208 374	118	753 211 611	21	753 518 612	133	753 665 587	115
753 208 388	118	753 211 612	21	753 518 613	133	753 665 588	115
753 208 389	118	753 221 031	118	753 518 614	133	753 665 589	115
753 208 391	118	753 221 032	118	753 528 412	134	753 665 590	115
753 208 412	119	753 251 010	73	753 528 413	134	753 665 591	115
753 208 413	119	753 251 011	73	753 528 414	134	753 665 592	115
753 208 414	119	753 251 012	73	753 528 606	133	753 665 593	115
753 208 524	119	753 251 013	73	753 528 607	133	753 665 594	115
753 208 525	119	753 251 014	73	753 528 608	133	753 665 595	115
753 208 526	119	753 251 044	78	753 528 609	133	753 700 611	189
753 208 527	119	753 251 063	74	753 528 610	133	753 700 612	189
753 208 535	119	753 251 064	74	753 528 611	133	753 700 613	189
753 208 536	119	753 312 012	98	753 528 612	133	753 700 614	189
753 208 540	119	753 312 013	98	753 528 613	133	753 700 615	189
753 208 541	119	753 312 014	98	753 528 614	133	753 700 616	189
753 208 542	119	753 312 015	98	753 608 412	135	753 700 617	189
753 208 543	119	753 312 016	98	753 608 413	135	753 700 618	189
753 208 544	119	753 312 017	98	753 608 414	135	753 700 619	189
753 208 545	119	753 312 018	98	753 608 612	133	753 700 620	189
753 208 546	119	753 312 019	98	753 608 613	133	753 700 621	189
753 208 547	119	753 312 020	98	753 608 614	133	753 700 622	189
753 208 548	119	753 312 021	98	753 648 412	135	753 700 623	189
753 208 606	118	753 312 022	98	753 648 413	135	753 700 624	189
753 208 607	118	753 312 023	98	753 648 414	135	753 700 625	189
753 208 608	118	753 312 024	98	753 648 606	134	753 700 626	189
753 208 609	118	753 312 025	98	753 648 607	134	753 700 627	189
753 208 610	118	753 314 000	129	753 648 608	134	753 700 628	189
753 208 611	118	753 314 001	129	753 648 609	134	753 700 629	189
753 208 612	118	753 314 002	129	753 648 610	134	753 790 206	191
753 208 613	118	753 318 006	130	753 648 611	134	753 790 207	191
753 208 614	118	753 318 007	130	753 648 612	134	753 790 208	191
753 208 615	118	753 318 008	130	753 648 613	134	753 790 209	191
753 208 616	118	753 318 009	130	753 648 614	134	753 790 210	191
753 208 617	118	753 318 010	130	753 665 558	115	753 790 211	191
753 208 619	118	753 318 011	130	753 665 559	115	753 790 212	191
753 208 620	118	753 318 036	130	753 665 560	115	753 790 213	191
753 208 624	118	753 318 037	130	753 665 561	115	753 790 214	191
753 208 625	118	753 318 038	130	753 665 562	115	753 798 210	179
753 208 626	118	753 318 039	130	753 665 563	115	753 798 211	179
753 208 627	118	753 318 040	130	753 665 564	115	753 798 212	179
753 208 668	118	753 318 041	130	753 665 565	115	753 798 213	179
753 208 671	118	753 508 606	133	753 665 566	115	753 798 214	179
753 208 672	118	753 508 607	133	753 665 567	115	753 798 215	179
753 208 673	118	753 508 608	133	753 665 568	115	753 798 216	179
753 211 034	22	753 508 609	133	753 665 569	115	753 798 217	179
753 211 035	22	753 508 610	133	753 665 570	115	753 798 218	179
753 211 037	22	753 508 611	133	753 665 571	115	753 798 219	179
753 211 039	22	753 508 616	134	753 665 572	115	753 798 220	179
753 211 040	22	753 508 617	134	753 665 573	115	753 798 221	179
753 211 059	22	753 508 618	134	753 665 574	115	753 798 222	179
753 211 060	22	753 508 619	134	753 665 575	115	753 798 223	179
753 211 063	22	753 508 620	134	753 665 576	115	753 798 224	179
753 211 069	22	753 508 621	134	753 665 577	115	753 798 225	179
753 211 070	22	753 518 412	134	753 665 578	115	753 798 226	179
753 211 073	22	753 518 413	134	753 665 579	115	753 798 227	179
753 211 080	22	753 518 414	134	753 665 580	115	753 798 306	177
753 211 083	22	753 518 606	133	753 665 581	115	753 798 307	177
753 211 606	21	753 518 607	133	753 665 582	115	753 798 308	177
753 211 607	21	753 518 608	133	753 665 583	115	753 798 309	177

Index

Code	Page	Code	Page	Code	Page	Code	Page
753 798 310	177	753 800 023	174	753 900 805	79	753 900 894	79
753 798 311	177	753 800 028	174	753 900 806	79	753 900 895	79
753 798 312	177	753 800 029	174	753 900 807	79	753 900 896	79
753 798 313	177	753 800 030	174	753 900 808	79	753 900 898	79
753 798 314	177	753 800 033	174	753 900 809	79	753 900 899	79
753 798 315	177	753 800 085	175	753 900 810	79	753 901 000	81
753 798 316	177	753 800 086	175	753 900 811	79	753 901 001	81
753 798 317	177	753 800 087	175	753 900 812	79	753 901 002	81
753 798 318	177	753 800 088	175	753 900 813	79	753 901 003	81
753 798 319	177	753 800 089	175	753 900 814	79	753 901 004	81
753 798 320	177	753 800 090	175	753 900 815	79	753 901 005	81
753 798 321	177	753 800 091	175	753 900 816	79	753 901 012	81
753 798 322	177	753 800 092	175	753 900 817	79	753 901 013	81
753 798 323	177	753 800 093	175	753 900 818	79	753 901 014	81
753 798 324	177	753 800 094	175	753 900 819	79	753 901 015	81
753 798 325	177	753 800 095	175	753 900 820	79	753 901 016	81
753 798 326	177	753 800 096	175	753 900 821	79	753 901 017	81
753 798 327	177	753 800 097	175	753 900 822	79	753 901 018	81
753 798 728	180	753 800 098	175	753 900 823	79	753 901 019	81
753 798 729	180	753 800 103	175	753 900 824	79	753 901 020	81
753 798 730	180	753 800 104	175	753 900 825	79	753 901 022	81
753 798 731	180	753 800 105	175	753 900 826	79	753 901 024	81
753 798 753	180	753 800 106	175	753 900 827	79	753 901 025	81
753 798 754	180	753 800 107	175	753 900 828	80	753 901 026	81
753 798 755	180	753 800 108	175	753 900 829	80	753 901 027	81
753 798 756	181	753 800 224	174	753 900 831	79	753 901 029	81
753 798 757	181	753 800 225	174	753 900 832	79	753 901 030	81
753 798 758	181	753 800 226	174	753 900 833	80	753 901 032	80
753 798 759	181	753 800 227	174	753 900 834	80	753 901 033	80
753 798 833	177	753 800 299	175	753 900 835	80	753 901 034	81
753 798 834	177	753 800 300	175	753 900 836	80	753 901 038	80
753 798 835	177	753 800 301	175	753 900 837	80	753 901 039	81
753 798 836	177	753 800 302	175	753 900 838	80	753 901 040	81
753 798 858	179	753 900 001	120	753 900 839	80	753 901 041	80
753 798 859	179	753 900 002	120	753 900 840	80	753 901 042	80
753 798 860	179	753 900 004	120	753 900 841	80	753 901 043	81
753 798 861	179	753 900 007	120	753 900 842	80	753 901 044	81
753 798 862	179	753 900 011	120	753 900 843	80	753 901 045	81
753 798 863	179	753 900 012	120	753 900 844	80	753 901 046	80
753 798 924	180	753 900 013	120	753 900 866	79	753 901 047	80
753 798 925	180	753 900 014	120	753 900 867	79	753 901 048	80
753 798 926	180	753 900 015	120	753 900 868	79	753 901 049	81
753 798 927	180	753 900 016	120	753 900 870	79	753 901 050	81
753 798 951	180	753 900 017	120	753 900 872	79	753 901 052	80
753 798 952	180	753 900 018	120	753 900 873	79	753 901 053	80
753 800 006	174	753 900 019	120	753 900 874	79	753 901 054	80
753 800 007	174	753 900 020	121	753 900 875	79	753 901 055	80
753 800 008	174	753 900 021	121	753 900 876	79	753 901 058	80
753 800 009	174	753 900 022	121	753 900 877	79	753 901 059	80
753 800 010	174	753 900 023	121	753 900 880	79	753 901 060	80
753 800 011	174	753 900 024	121	753 900 881	79	753 901 063	80
753 800 012	174	753 900 025	121	753 900 882	79	753 901 064	80
753 800 013	174	753 900 026	121	753 900 884	79	753 901 065	80
753 800 014	174	753 900 027	121	753 900 885	79	753 901 066	80
753 800 015	174	753 900 035	121	753 900 886	79	753 901 067	81
753 800 016	174	753 900 036	121	753 900 887	79	753 901 068	81
753 800 017	174	753 900 037	121	753 900 888	79	753 901 070	80
753 800 018	174	753 900 800	79	753 900 889	79	753 901 071	80
753 800 019	174	753 900 801	79	753 900 890	79	753 901 072	80
753 800 020	174	753 900 802	79	753 900 891	79	753 901 073	80
753 800 021	174	753 900 803	79	753 900 892	79	753 901 074	80
753 800 022	174	753 900 804	79	753 900 893	79	753 901 075	80

Index

Code	Page	Code	Page	Code	Page	Code	Page
753 901 076	80	753 902 823	122	753 908 881	120	753 909 839	121
753 901 077	80	753 902 824	122	753 908 883	120	753 909 840	121
753 901 078	80	753 902 825	122	753 908 885	120	753 909 841	121
753 901 080	80	753 902 826	122	753 908 887	120	753 909 842	121
753 901 081	80	753 902 827	122	753 908 890	120	753 909 843	121
753 901 082	80	753 902 828	122	753 908 891	120	753 909 844	121
753 901 083	80	753 902 829	123	753 908 892	120	753 909 845	121
753 901 084	80	753 902 830	123	753 908 895	120	753 909 846	121
753 901 085	80	753 902 831	123	753 908 896	120	753 909 859	123
753 901 086	80	753 902 832	123	753 908 897	120	753 909 860	123
753 901 087	80	753 902 833	123	753 908 904	122	753 909 861	123
753 901 088	80	753 902 834	123	753 908 912	122	753 909 862	123
753 901 089	80	753 902 835	123	753 908 916	122	753 909 866	123
753 901 090	80	753 902 836	123	753 908 917	122	753 909 867	123
753 901 091	80	753 902 837	123	753 908 920	122	753 909 868	123
753 901 092	81	753 902 838	123	753 908 922	122	753 909 869	123
753 901 094	81	753 902 839	123	753 908 926	122	753 909 870	123
753 901 095	81	753 902 840	123	753 908 927	122	753 909 872	123
753 901 096	81	753 902 841	123	753 908 928	122	753 909 873	123
753 901 097	81	753 902 842	123	753 908 931	122	753 909 874	123
753 901 098	81	753 902 843	123	753 908 932	122	753 909 875	123
753 901 099	81	753 902 844	123	753 908 933	122	753 909 876	123
753 901 639	24	753 902 845	123	753 908 937	122	753 909 877	123
753 901 640	24	753 902 846	123	753 908 938	122	753 909 879	123
753 901 641	24	753 908 464	122	753 908 939	122	753 909 880	123
753 901 644	24	753 908 465	122	753 908 943	122	753 909 881	123
753 901 645	24	753 908 470	122	753 908 944	122	753 909 882	123
753 901 646	24	753 908 471	122	753 908 949	122	753 909 883	123
753 901 651	24	753 908 476	122	753 908 950	122	753 909 884	123
753 901 652	24	753 908 477	122	753 908 975	122	753 909 885	123
753 901 656	24	753 908 637	120	753 908 976	122	753 909 886	123
753 901 657	24	753 908 641	120	753 908 977	122	753 909 887	123
753 901 658	24	753 908 642	120	753 908 978	122	753 909 888	123
753 901 831	24	753 908 646	120	753 908 979	122	753 909 889	123
753 901 832	24	753 908 647	120	753 908 981	122	753 909 890	123
753 901 833	24	753 908 648	120	753 908 985	122	753 909 891	123
753 901 836	24	753 908 652	120	753 908 999	122	753 909 892	123
753 901 837	24	753 908 653	120	753 909 809	121	753 909 893	124
753 901 838	24	753 908 654	120	753 909 810	121	753 909 894	124
753 901 839	24	753 908 658	120	753 909 811	121	753 909 895	124
753 901 840	24	753 908 659	120	753 909 812	121	753 909 896	124
753 901 841	24	753 908 660	120	753 909 816	121	753 910 266	128
753 901 842	24	753 908 664	120	753 909 817	121	753 910 267	128
753 901 845	24	753 908 665	120	753 909 818	121	753 910 268	128
753 901 864	24	753 908 666	120	753 909 819	121	753 910 269	128
753 901 865	24	753 908 670	120	753 909 820	121	753 910 270	128
753 902 801	122	753 908 671	120	753 909 822	121	753 910 271	128
753 902 802	122	753 908 676	120	753 909 823	121	753 910 556	128
753 902 804	122	753 908 677	120	753 909 824	121	753 910 557	128
753 902 807	122	753 908 680	120	753 909 825	121	753 910 558	128
753 902 811	122	753 908 684	120	753 909 826	121	753 910 559	128
753 902 812	122	753 908 685	120	753 909 827	121	753 910 560	128
753 902 813	122	753 908 688	120	753 909 829	121	753 910 561	128
753 902 814	122	753 908 690	120	753 909 830	121	753 910 906	114
753 902 815	122	753 908 692	120	753 909 831	121	753 910 907	114
753 902 816	122	753 908 695	120	753 909 832	121	753 910 908	114
753 902 817	122	753 908 696	120	753 909 833	121	753 910 909	114
753 902 818	122	753 908 697	120	753 909 834	121	753 910 910	114
753 902 819	122	753 908 877	120	753 909 835	121	753 910 911	114
753 902 820	122	753 908 878	120	753 909 836	121	753 910 912	114
753 902 821	122	753 908 879	120	753 909 837	121	753 910 913	114
753 902 822	122	753 908 880	120	753 909 838	121	753 910 914	114

Index

Code	Page	Code	Page	Code	Page	Code	Page
753 911 606	15	753 960 611	190	753 961 017	82	799 199 289	59
753 911 607	15	753 960 612	190	753 961 018	82	799 199 321	59
753 911 608	15	753 960 613	190	753 961 019	82	799 199 322	59
753 911 609	15	753 960 614	190	753 961 020	82	799 199 323	59
753 911 610	15	753 960 615	190	753 961 021	82	799 199 327	59
753 911 611	15	753 960 616	190	753 961 606	25	799 199 328	59
753 911 612	15	753 960 617	190	753 961 607	25	799 298 023	204
753 911 613	15	753 960 618	190	753 961 608	25	799 350 364	204
753 911 614	15	753 960 619	190	753 961 609	25	799 496 011	204
753 911 615	15	753 960 620	190	753 961 610	25	800 000 101	141
753 911 616	15	753 960 621	190	753 961 611	25	800 000 102	141
753 911 617	15	753 960 622	190	753 961 617	25	800 000 103	141
753 911 618	15	753 960 623	190	753 961 619	25	800 000 104	141
753 911 619	15	753 960 624	190	753 961 620	25	800 000 105	141
753 911 620	15	753 960 625	190	753 961 621	25	800 000 106	141
753 911 621	15	753 960 626	190	753 961 712	26	800 000 107	141
753 911 622	15	753 960 627	190	753 961 713	26	800 000 111	141
753 911 623	15	753 960 628	190	753 961 714	26	800 000 112	141
753 911 652	16	753 960 629	190	753 961 715	26	800 000 113	141
753 911 704	15	753 960 810	82	753 961 716	26	800 000 114	141
753 911 705	15	753 960 811	82	753 961 717	26	800 000 115	141
753 911 706	15	753 960 812	82	753 961 718	26	800 000 116	141
753 911 707	15	753 960 813	82	753 961 719	26	800 000 117	141
753 911 708	15	753 960 814	82	753 961 720	26	800 000 125	144
753 911 709	15	753 960 815	82	753 968 606	129	800 000 126	144
753 911 710	15	753 960 816	82	753 968 607	129	800 000 127	144
753 911 711	15	753 960 817	82	753 968 608	129	800 000 135	144
753 911 804	17	753 960 818	82	753 968 609	129	800 000 136	144
753 911 805	17	753 960 819	82	753 968 610	129	800 000 137	144
753 911 806	17	753 960 820	82	753 968 611	129	800 000 142	142
753 911 807	17	753 960 821	82	775 641 502	31	800 000 143	142
753 911 808	17	753 960 822	82	775 641 507	31	800 000 144	142
753 911 809	17	753 960 823	82	775 641 510	31	800 000 145	142
753 911 810	17	753 960 824	82	775 641 514	31	800 000 146	142
753 911 811	17	753 960 825	82	775 641 518	31	800 000 147	142
753 911 817	17	753 960 826	82	775 641 524	31	800 000 152	142
753 911 818	17	753 960 827	82	775 641 632	31	800 000 153	142
753 911 819	17	753 960 828	82	775 641 636	31	800 000 154	142
753 911 820	17	753 960 829	82	775 641 640	31	800 000 155	142
753 911 821	17	753 960 830	83	775 641 641	31	800 000 156	142
753 911 822	17	753 960 831	83	775 641 645	31	800 000 157	142
753 911 823	17	753 960 832	83	775 641 655	31	800 000 218	144
753 911 852	17	753 960 833	83	775 641 659	31	800 000 219	144
753 911 853	17	753 960 922	82	775 642 664	31	800 000 220	144
753 911 854	17	753 960 923	82	775 642 665	31	800 000 228	144
753 911 950	18	753 960 924	82	775 642 666	31	800 000 229	144
753 911 951	18	753 960 925	82	775 642 669	31	800 000 230	144
753 911 952	18	753 960 926	82	775 642 672	31	800 000 282	143
753 911 953	18	753 960 927	82	775 642 673	31	800 000 283	143
753 911 954	18	753 960 928	82	775 642 675	31	800 000 284	143
753 914 266	128	753 960 929	82	775 642 678	31	800 000 285	143
753 914 267	128	753 961 006	82	799 100 061	53	800 000 286	143
753 914 268	128	753 961 007	82	799 100 062	53	800 000 287	143
753 914 269	128	753 961 008	82	799 150 378	54	800 000 288	143
753 914 270	128	753 961 009	82	799 198 079	53	800 000 289	143
753 914 271	128	753 961 010	82	799 198 080	53	800 000 290	143
753 960 406	114	753 961 011	82	799 198 091	53	800 000 292	143
753 960 407	114	753 961 012	82	799 199 282	53	800 000 293	143
753 960 408	114	753 961 013	82	799 199 283	53	800 000 294	143
753 960 409	114	753 961 014	82	799 199 286	53	800 000 295	143
753 960 410	114	753 961 015	82	799 199 287	53, 59	800 000 296	143
753 960 411	114	753 961 016	82	799 199 288	59	800 000 297	143

Index

Code	Page
800 000 298	143
800 000 299	143
800 000 300	143
800 015 141	151
800 015 142	151
800 015 143	151
800 015 179	151
800 024 832	151
800 024 834	151
800 045 326	151
800 045 327	151
800 045 328	151
800 050 308	150
800 050 344	150
800 050 345	150
800 050 346	150
800 050 347	150
800 050 348	150
800 050 837	150
800 050 838	150
800 050 839	150

General Condition of Supply of Georg Fischer Piping Systems Limited, Schaffhausen

1 General

- 1.1 These General Conditions shall apply to all Products supplied by Georg Fischer Piping Systems Limited («Georg Fischer») to the Purchaser.
They shall also apply to all future business even when no express reference is made to them.
- 1.2 Any deviating or supplementary conditions especially Purchaser's general conditions of purchase and verbal agreements shall only be applicable if accepted in writing by Georg Fischer.
- 1.3 The written form shall be deemed to be fulfilled by all forms of transmission, evidenced in the form of text, such as telefax, e-mail, etc.

2 Tenders

- Tenders shall only be binding if they contain a specifically stated period for acceptance.

3 Scope of Delivery

- 3.1 Georg Fischer's product range is subject to change.
- 3.2 The confirmation of order shall govern the scope and execution of the contract.

4 Data and Documents

- 4.1 Technical documents such as drawings, descriptions, illustrations and data on dimensions, performance and weight as well as the reference to standards are for information purposes only. They are not warranted characteristics and are subject to change.
- 4.2 All technical documents shall remain the exclusive property of Georg Fischer and may only be used for the agreed purposes or as Georg Fischer may consent.

5 Confidentiality, Protection of Personal Data

- 5.1 Each party shall keep in strict confidence all commercial or technical information relating to the business of the other party, of which it has gained knowledge in the course of its dealing with the other party. Such information shall neither be disclosed to third parties nor used for other purposes than those for which the information has been supplied.
- 5.2 In the context of the contractual relation with the Purchaser personal data may be processed. The Purchaser agrees to the disclosure of said data to third parties such as foreign subcontractors and suppliers etc.

6 Local Laws and Regulations, Export Controls

- 6.1 The Purchaser shall bring to the attention of Georg Fischer all local laws and regulations at the place of destination which bear connection with the execution of the contract and the adherence to relevant safety regulations and approval procedures.
- 6.2 In case of re-exports, Purchaser shall be responsible for compliance with pertinent export control regulations.

7 Price

- 7.1 Unless agreed otherwise, the prices shall be deemed quoted net ex works (according to Incoterms 2010 of the ICC, or latest version) including standard packing. All supplementary costs such as the cost of carriage, insurance, export-, transit- and import- licences etc. shall be borne by the Purchaser. The Purchaser shall also bear the costs of all taxes, fees, duties etc. connected with the contract.
- 7.2 If the costs of packing, carriage, insurance, fees and other supplementary costs are included in the tender price or contract price or are referred to specifically in the tender or confirmation of order, Georg Fischer reserve the right to revise their prices accordingly should any change occur in the relevant tariffs.

8 Terms of Payment

- 8.1 The Purchaser shall make payment in the manner agreed by the parties without any deductions such as discounts, costs, taxes or dues.
- 8.2 The Purchaser may only withhold or off-set payments due against counter claims which are either expressly acknowledged by Georg Fischer or finally awarded to the Purchaser.
In particular, payment shall still be made when unessential items are still outstanding provided that the Products already delivered are not rendered unusable as a result.

9 Retention of Title

- 9.1 The Products shall remain the property of Georg Fischer until the Purchaser shall have settled all claims, present and future, which Georg Fischer may have against him.
- 9.2 Should the Purchaser resell Products to which title is reserved, in the ordinary course of business, he shall hereby be deemed to have tacitly assigned to Georg Fischer the proceeds deriving from their sale together with all collateral rights, securities and reservations of title until all claims held by Georg Fischer shall have been settled. Until revoked by Georg Fischer, this assignment shall not preclude Purchaser's right to collect the assigned receivables.
- 9.3 To the extent the value of the Products to which title is reserved together with collateral securities exceeds Georg Fischer's claims against the Purchaser by more than 20%, Georg Fischer shall re-assign the above proceeds to Purchaser at his request.

10 Delivery

- 10.1 The term of delivery shall commence as soon as the contract has been entered into, all official formalities such as import and payment permits have been obtained and all essential technical issues have been settled. The term of delivery shall be deemed duly observed when, upon its expiry, the Products are ready for despatch.
- 10.2 Delivery is subject to the following conditions, i.e. the term of delivery shall be reasonably extended:
 - a) if Georg Fischer are not supplied in time with the information necessary for the execution of the contract or if subsequent changes causing delays are made by the Purchaser.
 - b) if Georg Fischer are prevented from performing the contract by force majeure. Force majeure shall equally be deemed to be any unforeseeable event beyond Georg Fischer's control which renders Georg Fischer's performance commercially impractical or impossible, such as delayed or defective supplies from sub contractors labour disputes, governmental orders or regulations, shortages in materials or energy, serious disturbances in Georg Fischer's works, such as the total or partial destruction of plant and equipment or the breakdown of essential facilities, serious disruptions in transport facilities, e.g. impassable roads.
Should the effect of force majeure exceed a period of six (6) months, either party may cancel the contract forthwith.
Georg Fischer shall not be liable for any damage or loss of any kind whatsoever resulting therefrom, any suspension or cancellation being without prejudice to Georg Fischer's right to recover all sums due in respect of consignments delivered and costs incurred to date.
 - c) if the Purchaser is in delay with the fulfilment of his obligations under the contract, in particular, if he does not adhere to the agreed conditions of payment or if he has failed to timely provide the agreed securities.
- 10.3 If for reasons attributable to Georg Fischer the agreed term of delivery or a reasonable extension thereof is exceeded, Georg Fischer shall not be deemed in default until the Purchaser has granted to Georg Fischer in writing a reasonable extension thereof of not less than one (1) month which equally is not met.
The Purchaser shall then be entitled to the remedies provided at law, it being however understood that, subject to limitations of Art. 16, damage claims shall be limited to max. 10% of the price of the delayed delivery.
- 10.4 Part shipments shall be allowed and Georg Fischer shall be entitled to invoice for such partial deliveries.
- 10.5 If the Purchaser fails to take delivery within a reasonable time of Products notified as ready for despatch, Georg Fischer shall be entitled to store the Products at the Purchaser's expense and risk and to invoice them as delivered. If Purchaser fails to effect payment, Georg Fischer shall be entitled to dispose of the Products.
- 10.6 Should Purchaser cancel an order without justification and should Georg Fischer not insist on the performance of the contract, Georg Fischer shall be entitled to a penalty amounting to 10% of the contract price, Georg Fischer's right to prove and claim higher damages remaining reserved.

Purchaser shall be entitled to prove, that Georg Fischer has suffered no or a considerably lower damage than the penalty forfeited.

11 Packing

If the Products are provided with additional packing over and above the standard packing, such packing shall be charged additionally.

12 Passing of Risk

- 12.1 The risk in the Products shall pass to the Purchaser as soon as they have left Georg Fischer's works (EX WORKS, Incoterms 2010 ICC, or latest version), even if delivery is made carriage-paid, under similar clauses or including installation or when carriage is organized and managed by Georg Fischer.
- 12.2 If delivery is delayed for reasons beyond Georg Fischer's control, the risk shall pass to the Purchaser when he is notified that the Products are ready for despatch.

13 Carriage and Insurance

- 13.1 Unless agreed otherwise, the Purchaser shall bear the cost of carriage.
 - 13.2 The Purchaser shall be responsible for transport insurance against damage of whatever kind. Even when such insurance is arranged by Georg Fischer it shall be deemed taken out by the order of and for the account of the Purchaser and at his risk.
 - 13.3 Special requests regarding carriage and insurance shall be communicated to Georg Fischer in due time. Otherwise carriage shall be arranged by Georg Fischer at their discretion, but without responsibility, by the quickest and cheapest method possible.
In case of carriage-paid delivery transport arrangements shall be made by Georg Fischer. If the Purchaser specifies particular requirements, any extra costs involved shall be borne by him.
 - 13.4 In the event of damage or loss of the Products during carriage the Purchaser shall mark the delivery documents accordingly and immediately have the damage ascertained by the carrier. Not readily ascertainable damages sustained during carriage shall be notified to the carrier within six (6) days after receipt of the Products.
- ## 14 Inspection, Notification of Defects and Damages
- 14.1 The Products will be subject to normal inspection by Georg Fischer during manufacture. Additional tests required by the Purchaser shall be agreed upon in writing and shall be charged to the Purchaser.
 - 14.2 It shall be a condition of Georg Fischer's obligation under the warranties stated hereinafter that Georg Fischer be notified in writing by the Purchaser of any purported defect immediately upon discovery. Notice concerning weight, numbers or apparent defects is to be given latest within 30 days from receipt of the Products, notice of other defects immediately latest within seven (7) working days after discovery, in any event within the agreed warranty period.
 - 14.3 Purchaser shall not dispose of allegedly defective Products until all warranty and/or damage claims are finally settled. At its request, defective Products are to be placed at Georg Fischer's disposal.
 - 14.4 At its request, Georg Fischer shall be given the opportunity to inspect the defect and/or damage, prior to commencement of remedial work, either itself or by third party experts.

15 Warranty

- 15.1 At the written request of the Purchaser, Georg Fischer undertakes to repair or replace at its discretion, as quickly as possible and free of charge, all Products supplied which demonstrably suffer from faulty design, materials or workmanship, from faulty operating or installation instructions or which become defective or unusable due to faulty advice.
In order to protect employees from toxic or radioactive substances which may have been transported through defective parts returned to Georg Fischer's sales organisation, said parts must be accompanied by a Material Safety Disclosure Form. The form may be obtained from Georg Fischer's local sales company or via www.piping.georgfischer.com.
Replaced parts shall become property of Georg Fischer, unless Georg Fischer waives such claim.
- 15.2 For Products which are manufactured to specifications, drawings or patterns supplied by the Purchaser, Georg Fischer's warranty shall be restricted to proper materials and workmanship.
- 15.3 The Purchaser shall be entitled to rescind the contract or to demand a reduction of the contract price if
 - the repair or replacement of the defective Product is impossible
 - the defective Product is not repaired or replaced within a reasonable period
 - Georg Fischer refuses the repair or replacement or if for reasons attributable to Georg Fischer the repair or replacement is delayed.
- 15.4 For Products or essential components manufactured by a third party and supplied by Georg Fischer under this contract, Georg Fischer's warranty is limited to the warranty provided by said third party.
- 15.5 This warranty shall not apply to damage resulting from normal wear and tear, improper storage and maintenance, failure to observe the operating instructions, overstressing or overloading, unsuitable operating media, unsuitable construction work or unsuitable building ground, improper repairs or alterations by the Purchaser or third parties, the use of other than original spare parts and other reasons beyond Georg Fischer's control.
- 15.6 No action or claim may be brought by the Purchaser on account of any alleged breach of warranty or any other obligation of Georg Fischer after the expiration of twelve (12) months from receipt of the Products by the end user or at the latest within eighteen (18) months of the Products being despatched by Georg Fischer.
- 15.7 In case of Products for use in domestic installations or in utilities
 - Georg Fischer will assume the costs of dismantling the defective Product and restoring the damaged object up to CHF 1'000'000 per occurrence.
 - warranty or damage claims - contrary to Section 15.6 - are time-barred five (5) years from the date of installation or seven (7) years from the production date, whichever is earlier.

16 Limitation of Liability

The rights and remedies of the customer shall be exclusively governed by these General Conditions of Supply and shall be in lieu of any remedies at law. All further claims for damages, reduction of the purchase price, termination of or rescission of the contract are excluded. In no case whatsoever shall the customer be entitled to claim damages other than compensation for costs of remedying defects in the supplies. This in particular refers, but shall not be limited, to loss of production, loss of use, loss of orders, loss of profit, third party recovery claims and other direct or indirect or consequential damages.
This limitation of liability equally applies to the extent Georg Fischer is liable for acts or omissions of its employees or third parties engaged for the performance of its obligations. It does not apply in case of unlawful intent or gross negligence on the part of Georg Fischer's management and in case of Georg Fischer's statutory liability, in particular under applicable product liability laws.

17 Severability

Should any term or clause of these General Conditions in whole or in part be found to be unenforceable or void, all other provisions shall remain in full force and effect and the unenforceable or void provision shall be replaced by a valid provision, which comes closest to the original intention of the unenforceable or invalid provision.

18 Place of Performance and Jurisdiction

- 18.1 Place of performance for the Products shall be the Georg Fischer works from which the Products are despatched.
- 18.2 The contract shall be governed by Swiss law without regard to conflict of law provisions that would require the application of another law.
- 18.3 Any civil action based upon any alleged breach of this contract shall be filed and prosecuted exclusively in the courts of Schaffhausen, Switzerland.
Georg Fischer however reserves the right to file actions in any court having jurisdiction over controversies arising out of or in connection with the present contract.

Worldwide at Home

Our sales companies and representatives ensure local customer support in over 100 countries

www.gfps.com

Argentina / Southern South America

Georg Fischer Central Plastics Sudamérica S.R.L.
Buenos Aires, Argentina
Phone +54 11 4512 02 90
gfccentral.ps.ar@georgfischer.com
www.gfps.com/ar

Australia

George Fischer Pty Ltd
Riverwood NSW 2210 Australia
Phone +61 (0) 2 9502 8000
australia.ps@georgfischer.com
www.gfps.com/au

Austria

Georg Fischer Rohrleitungssysteme GmbH
3130 Herzogenburg
Phone +43 (0) 2782 856 43-0
austria.ps@georgfischer.com
www.gfps.com/at

Georg Fischer Fittings GmbH
3160 Traisen
Phone +43 (0) 2762 90300
fittings.ps@georgfischer.com
www.fittings.at

Belgium / Luxembourg

Georg Fischer NV/SA
1600 Sint-Pieters-Leeuw / Belgium
Phone +32 (0) 2 556 40 20
Fax +32 (0) 2 524 34 26
be.ps@georgfischer.com
www.gfps.com/be

Brazil

Georg Fischer Sist. de Tub. Ltda.
04571-020 São Paulo/SP
Phone +55 (0) 11 5525 1311
br.ps@georgfischer.com
www.gfps.com/br

Canada

Georg Fischer Piping Systems Ltd
Mississauga, ON L5T 2B2
Phone +1 (905) 670 8005
Fax +1 (905) 670 8513
ca.ps@georgfischer.com
www.gfps.com/ca

China

Georg Fischer Piping Systems Ltd
Shanghai 201319
Phone +86 21 3899 3899
china.ps@georgfischer.com
www.gfps.com/cn

Chinaust Plastics Corp. Ltd.
Songlindian, Zhuozhou city,
Hebei province, China, 072761
Phone +86 312 395 2000
Fax +86 312 365 2222
chinaust@chinaust.com
www.chinaust.com.cn

Denmark / Iceland

Georg Fischer A/S
2630 Taastrup
Phone +45 (0) 70 22 19 75
info.dk.ps@georgfischer.com
www.gfps.com/dk

Finland

Georg Fischer AB
01510 VANTAA
Phone +358 (0) 9 586 58 25
Fax +358 (0) 9 586 58 29
info.fi.ps@georgfischer.com
www.gfps.com/fin

France

Georg Fischer SAS
95932 Roissy Charles de Gaulle Cedex
Phone +33 (0) 1 41 84 68 84
fr.ps@georgfischer.com
www.gfps.com/fr

Germany

Georg Fischer GmbH
73095 Albershausen
Phone +49 (0) 7161 302 0
info.de.ps@georgfischer.com
www.gfps.com/de

India

Georg Fischer Piping Systems Pvt. Ltd
400 083 Mumbai
Phone +91 22 4007 2000
Fax +91 22 4007 2020
branchoffice@georgfischer.com
www.gfps.com/in

Italy

Georg Fischer S.p.A.
20063 Cernusco S/N (MI)
Phone +39 02 921 861
it.ps@georgfischer.com
www.gfps.com/it

Georg Fischer TPA S.r.l.

IT-16012 Busalla (GE)
Phone +39 010 962 47 11
tpa.ps@georgfischer.com
www.gfps.com/it

Japan

Georg Fischer Ltd
530-0003 Osaka
Phone +81 (0) 6 6341 2451
jp.ps@georgfischer.com
www.gfps.com/jp

Korea

Georg Fischer Korea Co. Ltd
Unit 2501, U-Tower
120 HeungdeokJungang-ro
(Yeongdeok-dong)
Giheung-gu, Yongin-si, Gyeonggi-do
Phone +82 31 8017 1450
Fax +82 31 217 1454
kor.ps@georgfischer.com
www.gfps.com/kr

Malaysia

Georg Fischer (M) Sdn. Bhd.
40460 Shah Alam, Selangor Darul Ehsan
Phone +60 (0) 3 5122 5585
Fax +60 (0) 3 5122 5575
my.ps@georgfischer.com
www.gfps.com/my

Mexico / Northern Latin America

Georg Fischer S.A. de C.V.
Apodaca, Nuevo Leon
CP66636 Mexico
Phone +52 (81) 1340 8586
Fax +52 (81) 1522 8906
mx.ps@georgfischer.com
www.gfps.com/mx

Middle East

Georg Fischer Piping Systems (Switzerland) Ltd
Dubai, United Arab Emirates
Phone +971 4 289 49 60
gcc.ps@georgfischer.com
www.gfps.com/int

Netherlands

Georg Fischer N.V.
8161 PA Epe
Phone +31 (0) 578 678 222
nl.ps@georgfischer.com
www.gfps.com/nl

Georg Fischer Waga N.V.

NL-8160 AG Epe
Phone +31 (0) 578 678 378
waga.ps@georgfischer.com
www.waga.nl

Norway

Georg Fischer AS
1351 Rud
Phone +47 67 18 29 00
no.ps@georgfischer.com
www.gfps.com/no

Poland

Georg Fischer Sp. z o.o.
05-090 Sekocin Nowy
Phone +48 (0) 22 31 31 0 50
poland.ps@georgfischer.com
www.gfps.com/pl

Romania

Georg Fischer Piping Systems (Switzerland) Ltd
020257 Bucharest - Sector 2
Phone +40 (0) 21 230 53 80
ro.ps@georgfischer.com
www.gfps.com/int

Russia

Georg Fischer Piping Systems (Switzerland) Ltd
Moscow 125040
Phone +7 495 748 11 44
ru.ps@georgfischer.com
www.gfps.com/ru

Singapore

Georg Fischer Pte Ltd
11 Tampines Street 92, #04-01/07
528 872 Singapore
Phone +65 6747 0611
Fax +65 6747 0577
sgp.ps@georgfischer.com
www.gfps.com/sg

Spain / Portugal

Georg Fischer S.A.
28046 Madrid
Phone +34 (0) 91 781 98 90
es.ps@georgfischer.com
www.gfps.com/es

Sweden

Georg Fischer AB
117 43 Stockholm
Phone +46 (0) 8 506 775 00
info.se.ps@georgfischer.com
www.gfps.com/se

Switzerland

Georg Fischer Rohrleitungssysteme (Schweiz) AG
8201 Schaffhausen
Phone +41 (0) 52 631 3026
ch.ps@georgfischer.com
www.gfps.com/ch

Taiwan

Georg Fischer Co. Ltd
San Chung Dist., New Taipei City
Phone +886 2 8512 2822
Fax +886 2 8512 2823
www.gfps.com/tw

United Kingdom / Ireland

Georg Fischer Sales Limited
Coventry, CV2 2ST
Phone +44 (0) 2476 535 535
uk.ps@georgfischer.com
www.gfps.com/uk

USA / Caribbean

Georg Fischer LLC
9271 Jeronimo Road
92618 Irvine, CA
Phone +1 714 731 88 00
Fax +1 714 731 62 01
us.ps@georgfischer.com
www.gfps.com/us

Georg Fischer Central Plastics LLC

Shawnee, OK 74801
Phone +1 (405) 273 63 02
gfccentral.ps@georgfischer.com
www.centralplastics.com

International

Georg Fischer Piping Systems (Switzerland) Ltd
8201 Schaffhausen/Switzerland
Phone +41 (0) 52 631 3003
Fax +41 (0) 52 631 2893
info.export@georgfischer.com
www.gfps.com/int

The technical data are not binding. They neither constitute expressly warranted characteristics nor guaranteed properties nor a guaranteed durability. They are subject to modification. Our General Terms of Sale apply.