

JY-21 Manual

Input Voltage for circuit	DC+12V
Input Voltage for device	Based on Input voltage for device
Standby	Display shows:00:00, reply: Normal Open (NO)
Max current load	15A for total
Basic working way	User inserts coins → goes to balance → choose device to use by push button start → device start working
Check Balance	Push a button when stand by
Display	- Standby: shows 00:00 - Running Time: Shows remaining time If more than 2 devices are running, user can hold on button start for seconds to check time
Insert coins when time is running	- Credit goes to balance. - Add time after user push button start.
Time Setting	Please reference to A on page 2
Price setting	Please reference to B on page 2
Operating mode	Please reference to C on page 2
Connection example	Please reference to page 3

Connection

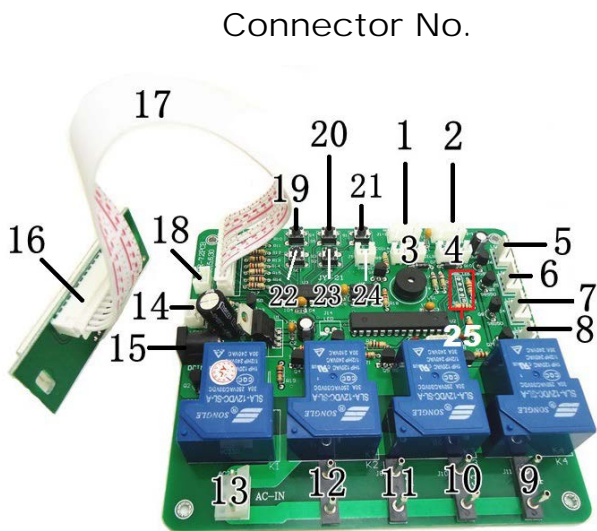

Connector No.

- 1-2: to counter (P2)
- 3-4: input device (P1)
- 5-8: button START for device 4 to 1 (P3)
- 9-12: output for device 4 to 1 (P5)
- 13: Input for device 9, 10, 11, and 12 (P5)
- 14: Input for this board- wire type:
RED: DC+12V, Black: GND
- 15: Input for this board-AC jack: 5.5mm*2.1mm
- 16: 4 digits Display
- 17: white lead
- 18: connector for button: check balance
- 19-23: setting button
- 24: pause connector
- 25: LED sign for 1-4 devices (P4)

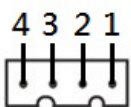

- 1: +12V
- 2: Input
- 3: GND
- 4: Counter input



- 1: +12V
- 2: Input,
- 3: GND
- 4: Counter output

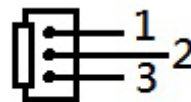

- 1: Signal-NO
- 2: GND
- 3: +5V

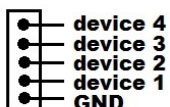

- LED Voltage: 3.3V

P4

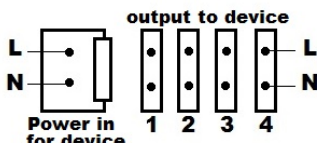

Power in for device P5

- Voltage for No. 13, and No. 9-No. 12 have to be the same
- Connection for 1,2,3,and 4 are the same

JY-21 Manual

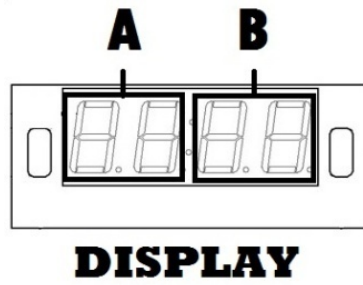
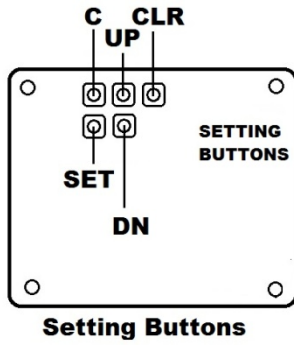

Max Time:99:59
A: 2 digit: either HOUR or MINUTE
B: 2 digits: either MINUTE or SECOND
 Please following page to adjust Time type.

A. Time Setting

Set up value: Please press button UP or DN to adjust number

1. Press button "SET", "B" flashes. Please set up TIME for first device.
2. Press button "SET", "A" flashes. Please set up TIME for first device.
3. Repeat step No.1 and No.2 to set up time for second – forth device.

B. Coin/Signal quantity and warning sound setting

1. Please press button "C". "A" shows 01. Please set up "Coin Quantity" for first device.
2. Please press button "C". "A" shows 02. Please set up "Coin Quantity" for second device.
3. Please press button "C". "A" shows 03. Please set up "Coin Quantity" for third device.
4. Please press button "C". "A" shows 04. Please set up "Coin Quantity" for forth device.
5. Please press button "C". "B" flashes. Please set up warning sound (1s-60s).

C. Operating Setting:

1. Please hold on button "SET" for seconds. "A" shows CODE.
2. Please use button "S1" and button "S2" to set up number for CODE
3. Please press button "S4" to switch to next code

Title	A	B	Description
Working way	01	01	Only 1 device can work simultaneously
		02	1-4 devices can work simultaneously
Light for button	02	03	Lights all the time
		04	Lights when devices can be used
		05	Lights when devices are working
Time Type	03	06	Hour: Minute
		07	Minute: Second
Memory	04	08	Yes, keeping running after re-power on
		09	No, standby after re-power on
Back to Standby	05		User has no action after push buttons or receive signals in setting time
Default: underline			

JY-21 Manual

Connection Example

No.1-NO.2



No.3-NO.4

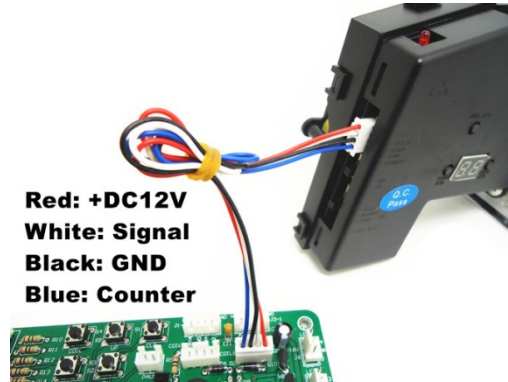

No.5-NO.8

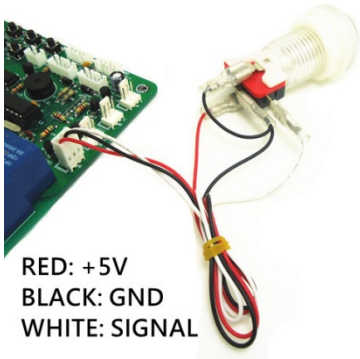

No.18

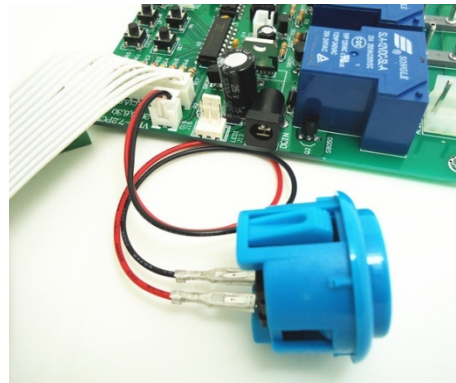

No.24

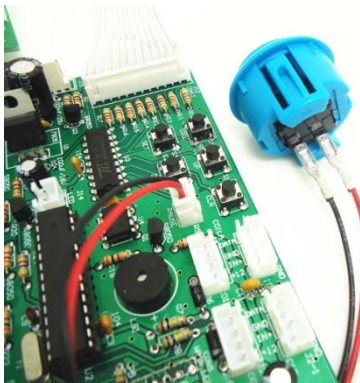

No.13 and No.9-No.12

